

TMS320 DSP/BIOS v5.42

User's Guide



Literature Number: SPRU423I
August 2012

Read This First

About This Manual

This manual describes DSP/BIOS 5.42, which may have been installed as part of the Code Composer Studio (CCS) 5.3 or higher installation. The standalone installer for DSP/BIOS 5.42 can be used with CCS 5.1 or CCS 5.2. (CCSv3 and CCSv4 are no longer supported by DSP/BIOS.)

DSP/BIOS gives developers of mainstream applications on Texas Instruments TMS320 DSP devices the ability to develop embedded real-time software. DSP/BIOS provides a small firmware real-time library and easy-to-use tools for real-time tracing and analysis.

You should read and become familiar with the *TMS320 DSP/BIOS API Reference Guide* for your platform. The API reference guide is a companion volume to this user's guide.

Notational Conventions

This document uses the following conventions:

- Program listings, code examples, and interactive displays are shown in a `special typeface`. Examples use a **bold version** of the special typeface for emphasis; interactive displays use a **bold version** of the special typeface to distinguish commands that you enter from items that the system displays (such as prompts, command output, error messages, etc.).

Here is a sample program listing:

```
Void copy(HST_Obj *input, HST_Obj *output)
{
    PIP_Obj      *in, *out;
    Uns          *src, *dst;
    Uns          size;
}
```

- Square brackets ([and]) identify an optional parameter. If you use an optional parameter, you specify the information within the brackets. Unless the square brackets are in a **bold** typeface, do not enter the brackets themselves.
- Throughout this manual, 64 can represent the two-digit numeric appropriate to your specific DSP platform. If your DSP platform is C62x based, substitute 62 each time you see the designation 64. For example, DSP/BIOS assembly language API header files for the C6000 platform will have a suffix of .h62. For the C2800 platform, the suffix will be .h28. For a C64x, C55x, or C28x DSP platform, substitute 64, 55, or 28 for each occurrence of 64. Also, each reference to Code Composer Studio C5000 can be substituted with Code Composer Studio C6000 depending on your DSP platform.
- Information specific to a particular device is designated with one of the following icons:



Related Documentation From Texas Instruments

The following sources describe TMS320 devices and related support tools. To obtain a copy of any of these TI documents, visit the Texas Instruments website at www.ti.com.

TMS320C28x DSP/BIOS API Reference (literature number SPRU625)

TMS320C5000 DSP/BIOS API Reference (literature number SPRU404)

TMS320C6000 DSP/BIOS API Reference (literature number SPRU403)

describes the DSP/BIOS API functions, which are alphabetized by name. The API Reference Guide is the companion to this user's guide.

DSP/BIOS Textual Configuration (Tconf) User's Guide (literature number SPRU007) describes the scripting language used to configure DSP/BIOS applications.

DSP/BIOS Driver Developer's Guide (literature number SPRU616)

describes the IOM model for device driver development and integration into DSP/BIOS applications.

DSP/BIOS wiki page:

<http://processors.wiki.ti.com/index.php/Category:DSPBIOS>

Code Composer Studio Online Help provides information about Code Composer Studio.

Code Composer Studio wiki page:

<http://processors.wiki.ti.com/index.php/CCSv5>

TMS320C2000 Assembly Language Tools User's Guide (SPRU513)

TMS320C55x Assembly Language Tools User's Guide (SPRU280)

TMS320C6000 Assembly Language Tools User's Guide (SPRU186)

describes the assembly language tools (assembler, linker, and other tools used to develop assembly language code), assembler directives, macros, common object file format, and symbolic debugging directives for the C5000 generation of devices.

TMS320C2000 Optimizing C/C++ Compiler User's Guide (literature number SPRU514) describes the C2000

C/C++ compiler and the assembly optimizer. This C/C++ compiler accepts ANSI standard C/C++ source code and produces assembly language source code for the C2000 generation of devices. The assembly optimizer helps you optimize your assembly code.

TMS320C55x Optimizing C Compiler User's Guide (literature number SPRU281) describes the C55x C

compiler. This C compiler accepts ANSI standard C source code and produces TMS320 assembly language source code for the C55x generation of devices.

TMS320C6000 Optimizing C Compiler User's Guide (literature number SPRU187) describes the C6000

C/C++ compiler and the assembly optimizer. This C/C++ compiler accepts ANSI standard C/C++ source code and produces assembly language source code for the C6000 generation of devices. The assembly optimizer helps you optimize your assembly code.

TMS320C55x Programmer's Guide (literature number SPRU376) describes ways to optimize C and assembly

code for the TMS320C55x DSPs and includes application program examples.

TMS320C6000 Programmer's Guide (literature number SPRU189) describes the C6000 CPU architecture,

instruction set, pipeline, and interrupts for these digital signal processors.

TMS320C6000 Peripherals Reference Guide (literature number SPRU190)

describes common peripherals available on the TMS320C6000 family of digital signal processors. This book includes information on the internal data and program memories, the external memory interface (EMIF), the host port, multichannel buffered serial ports, direct memory access (DMA), clocking and phase-locked loop (PLL), and the power-down modes.

TMS320C28x DSP CPU and Instruction Reference Guide (literature number SPRU430).

Related Documentation

You can use the following books to supplement this reference guide:

The C Programming Language (second edition), by Brian W. Kernighan and Dennis M. Ritchie, published by Prentice-Hall, Englewood Cliffs, New Jersey, 1988

Programming in C, Kochan, Steve G., Hayden Book Company

Programming Embedded Systems in C and C++, by Michael Barr, Andy Oram (Editor), published by O'Reilly & Associates; ISBN: 1565923545, February 1999

Real-Time Systems, by Jane W. S. Liu, published by Prentice Hall; ISBN: 013099651, June 2000

Principles of Concurrent and Distributed Programming (Prentice Hall International Series in Computer Science), by M. Ben-Ari, published by Prentice Hall; ISBN: 013711821X, May 1990

American National Standard for Information Systems-Programming Language C X3.159-1989, American National Standards Institute (ANSI standard for C); (out of print)

Trademarks

MS-DOS, Windows, and Windows NT are trademarks of Microsoft Corporation.

The Texas Instruments logo and Texas Instruments are registered trademarks of Texas Instruments. Trademarks of Texas Instruments include: TI, XDS, Code Composer, Code Composer Studio, Probe Point, Code Explorer, DSP/BIOS, RTDX, Online DSP Lab, BIOSuite, SPOX, TMS320, TMS320C54x, TMS320C55x, TMS320C62x, TMS320C64x, TMS320C67x, TMS320C28x, TMS320C5000, TMS320C6000 and TMS320C2000.

All other brand or product names are trademarks or registered trademarks of their respective companies or organizations.

August 15, 2012

1	About DSP/BIOS	12
1.1	DSP/BIOS Features and Benefits	12
1.2	DSP/BIOS Components	14
1.3	Naming Conventions	19
1.4	For More Information	24
2	Program Generation	25
2.1	Using DSP/BIOS in CCS Projects	26
2.2	Using the DSP/BIOS Configuration Tool	31
2.3	How hello.c Uses DSP/BIOS	32
2.4	The Development Cycle	33
2.5	Configuring DSP/BIOS Applications Statically	33
2.6	Creating DSP/BIOS Objects Dynamically	37
2.7	Files Used to Create DSP/BIOS Programs	39
2.8	Using Makefiles to Build Applications	40
2.9	Using DSP/BIOS with the Run-Time Support Library	42
2.10	DSP/BIOS Startup Sequence	43
2.11	Using C++ with DSP/BIOS	45
2.12	User Functions Called by DSP/BIOS	47
2.13	Calling DSP/BIOS APIs from Main	47
3	Instrumentation	49
3.1	An Overview of Real-Time Analysis	50
3.2	Real-Time Analysis Tools in CCS	51
3.3	RTOS Object Viewer (ROV)	59
3.4	Instrumentation Performance	62
3.5	Instrumentation APIs	64
3.6	Implicit DSP/BIOS Instrumentation	73
3.7	Instrumentation for Field Testing	79
3.8	Real-Time Data Exchange	79
4	Thread Scheduling	84
4.1	Overview of Thread Scheduling	84
4.2	Hardware Interrupts	91
4.3	Software Interrupts	102
4.4	Tasks	112
4.5	The Idle Loop	120
4.6	Power Management	121
4.7	Semaphores	127
4.8	Mailboxes	132
4.9	Timers, Interrupts, and the System Clock	137
4.10	Periodic Function Manager (PRD) and the System Clock	140

5	Memory and Low-level Functions	143
5.1	Memory Management	143
5.2	System Services	151
5.3	Queues	153
6	Input/Output Methods	158
6.1	I/O Overview	158
6.2	Comparing Pipes and Streams	159
6.3	Comparing Driver Models	160
6.4	Data Pipe Manager (PIP Module)	163
6.5	Message Queues	167
6.6	Host Channel Manager (HST Module)	176
6.7	I/O Performance Issues	178
7	Streaming I/O and Device Drivers	179
7.1	Overview of Streaming I/O and Device Drivers	180
7.2	Creating and Deleting Streams	182
7.3	Stream I/O—Reading and Writing Streams	183
7.4	Stackable Devices	192
7.5	Controlling Streams	196
7.6	Selecting Among Multiple Streams	197
7.7	Streaming Data to Multiple Clients	198
7.8	Streaming Data Between Target and Host	199
7.9	Device Driver Template	200
7.10	Streaming DEV Structures	201
7.11	Device Driver Initialization	203
7.12	Opening Devices	203
7.13	Real-Time I/O	206
7.14	Closing Devices	209
7.15	Device Control	210
7.16	Device Ready	211
7.17	Types of Devices	213

Figures

1-1	DSP/BIOS Components	14
1-2	Configuration Tool Module Tree	17
2-1	Files in a DSP/BIOS Application	39
3-1	LOG Buffer Sequence	66
3-2	Target/Host Variable Accumulation	67
3-3	Current Value Deltas From One STS_set.	69
3-4	Current Value Deltas from Base Value.	70
3-5	Monitoring Stack Pointers (C5000 platform)	75
3-6	Monitoring Stack Pointers (C6000 platform)	75
3-7	Calculating Used Stack Depth	76
3-8	RTDX Data Flow between Host and Target	80
4-1	Thread Priorities	89
4-2	Preemption Scenario	91
4-3	The Interrupt Sequence in Debug Halt State	95
4-4	The Interrupt Sequence in the Run-time State	97
4-5	Software Interrupt Manager	104
4-6	SWI Properties Dialog Box	105
4-7	Using SWI_inc to Post an SWI	108
4-8	Using SWI_andn to Post an SWI	109
4-9	Using SWI_or to Post an SWI.	109
4-10	Using SWI_dec to Post an SWI	110
4-11	Execution Mode Variations	114
4-12	Trace from Example 4-7	120
4-13	Power Event Notification.	125
4-14	Trace Results from Example 4-11	132
4-15	Trace Results from Example 4-15	136
4-16	Interactions Between Two Timing Methods	137
4-17	Trace Log Output from Example 4-16.	140
5-1	Allocating Memory Segments of Different Sizes	148
5-2	Memory Allocation Trace	151
5-3	Trace Results from Example 5-18	157
6-1	Input/Output Stream	159
6-2	The Two Ends of a Pipe	163
6-3	Writers and Reader of a Message Queue	168
6-4	Components of the MSGQ Architecture	169
6-5	MSGQ Function Calling Sequence.	169
6-6	Transports in a Multi-Processor Example.	173
6-7	Remote Transport.	174
6-8	Events on Sending Message to Remote Processor	175
7-1	Device-Independent I/O in DSP/BIOS	180
7-2	Device, Driver, and Stream Relationship	182
7-3	How SIO_get Works	185
7-4	Output Trace for Example 7-5	188
7-5	Results for Example 7-6.	190

7-6	The Flow of Empty and Full Frames	193
7-7	Sine Wave Output for Example 7-9	196
7-8	Flow of DEV_STANDARD Streaming Model	207
7-9	Placing a Data Buffer to a Stream	207
7-10	Retrieving Buffers from a Stream	208
7-11	Stacking and Terminating Devices	213
7-12	Buffer Flow in a Terminating Device	214
7-13	In-Place Stacking Driver	214
7-14	Copying Stacking Driver Flow	215

Tables

1-1	DSP/BIOS Modules	15
1-2	DSP/BIOS Standard Data Types:	21
1-3	Memory Segment Names	22
1-4	Standard Memory Segments	23
2-1	Methods of Referencing C6000 Global Objects	35
2-2	Files Not Included in rtsbios	42
2-3	Stack Modes on the C5500 Platform	45
3-1	Examples of Code-size Increases Due to an Instrumented Kernel	64
3-2	TRC Constants:	71
3-3	Variables that can be Monitored with HWI	77
3-4	STS Operations and Their Results	78
4-1	Comparison of Thread Characteristics	87
4-2	Comparison of Thread Characteristics (continued)	88
4-3	Thread Preemption	90
4-4	SWI Object Function Differences	107
4-5	CPU Registers Saved During Software Interrupt	111
6-1	Comparison of Pipes and Streams	160
7-1	Generic I/O to Internal Driver Operations	181

Examples

2-1	Creating and Referencing Dynamic Objects	2-38
2-2	Deleting a Dynamic Object	2-38
2-3	Sample Makefile for a DSP/BIOS Program	2-41
2-4	Declaring Functions in an Extern C Block.....	2-46
2-5	Function Overloading Limitation	2-46
2-6	Wrapper Function for a Class Method	2-46
3-1	Gathering Information About Differences in Values.....	3-69
3-2	Gathering Information About Differences from Base Value	3-70
3-3	The Idle Loop	3-74
4-1	Interrupt Behavior for C28x During Real-Time Mode.....	4-94
4-2	Code Regions That are Uninterruptible	4-98
4-3	Constructing a Minimal ISR on C6000 Platform	4-101
4-4	HWI Example on C55x Platform	4-102
4-5	HWI Example on C28x Platform	4-102
4-6	Creating a Task Object	4-117
4-7	Time-Slice Scheduling	4-118
4-8	Creating and Deleting a Semaphore.....	4-127
4-9	Setting a Timeout with SEM_pend.....	4-128
4-10	Signaling a Semaphore with SEM_post.....	4-128
4-11	SEM Example Using Three Writer Tasks	4-129
4-12	Creating a Mailbox	4-132
4-13	Reading a Message from a Mailbox	4-133
4-14	Posting a Message to a Mailbox	4-133
4-15	MBX Example With Two Types of Tasks.....	4-134
4-16	Using the System Clock to Drive a Task.....	4-140
5-1	Linker Command File (C6000 Platform)	5-145
5-2	Linker Command File (C55x and C28x Platforms)	5-145
5-3	Using MEM_alloc for System-Level Storage	5-146
5-4	Allocating an Array of Structures	5-146
5-5	Using MEM_free to Free Memory	5-147
5-6	Freeing an Array of Objects	5-147
5-7	Memory Allocation (C5000 and C28x Platforms).....	5-149
5-8	Memory Allocation (C6000 Platform)	5-150
5-9	Coding To Halt Program Execution with SYS_exit or SYS_abort.....	5-151
5-10	Using SYS_abort with Optional Data Values	5-152
5-11	Using Handlers in SYS_exit.....	5-152
5-12	Using Multiple SYS_NUMHANDLERS	5-152
5-13	DSP/BIOS Error Handling	5-152
5-14	Using doError to Print Error Information	5-153
5-15	Managing QUE Elements Using Queues.....	5-153
5-16	Inserting into a Queue Atomically	5-154

5-17	Using QUE Functions with Mutual Exclusion Elements	5-154
5-18	Using QUE to Send Messages	5-155
7-1	Creating a Stream with SIO_create	7-183
7-2	Freeing User-Held Stream Buffers.....	7-183
7-3	Inputting and Outputting Data Buffers.....	7-184
7-4	Implementing the Issue/Reclaim Streaming Model	7-184
7-5	Basic SIO Functions	7-186
7-6	Adding an Output Stream to Example 7-5	7-189
7-7	Using the Issue/Reclaim Model	7-191
7-8	Opening a Pair of Virtual Devices	7-192
7-9	Data Exchange Through a Pipe Device	7-194
7-10	Using SIO_ctrl to Communicate with a Device	7-196
7-11	Changing Sample Rate	7-197
7-12	Synchronizing with a Device	7-197
7-13	Indicating That a Stream is Ready.....	7-197
7-14	Polling Two Streams	7-198
7-15	Using SIO_put to Send Data to Multiple Clients	7-198
7-16	Using SIO_issue/SIO_reclaim to Send Data to Multiple Clients	7-199
7-17	Required Statements in dxx.h Header File	7-200
7-18	Table of Device Functions	7-201
7-19	The DEV_Fxns Structure	7-201
7-20	The DEV_Frame Structure	7-201
7-21	The DEV_Handle Structure	7-202
7-22	Initialization by Dxx_init.....	7-203
7-23	Opening a Device with Dxx_open.....	7-203
7-24	Opening an Input Terminating Device	7-204
7-25	Arguments to Dxx_open	7-204
7-26	The Parameters of SIO_create	7-204
7-27	The Dxx_Obj Structure	7-205
7-28	Typical Features for a Terminating Device	7-205
7-29	Template for Dxx_issue for a Typical Terminating Device.....	7-208
7-30	Template for Dxx_reclaim for a Typical Terminating Device	7-208
7-31	Closing a Device	7-209
7-32	Making a Device Ready	7-211
7-33	SIO_Select Pseudocode	7-212

About DSP/BIOS

DSP/BIOS is a scalable real-time kernel. It is designed to be used by applications that require real-time scheduling and synchronization, host-to-target communication, or real-time instrumentation. DSP/BIOS provides preemptive multi-threading, hardware abstraction, real-time analysis, and configuration tools.

Topic	Page
1.1 DSP/BIOS Features and Benefits	12
1.2 DSP/BIOS Components	14
1.3 Naming Conventions	19
1.4 For More Information	24

1.1 DSP/BIOS Features and Benefits

DSP/BIOS is designed to minimize memory and CPU requirements on the target. This design goal is accomplished in the following ways:

- All DSP/BIOS objects can be configured statically and bound into an executable program image. This reduces code size and optimizes internal data structures.
- Instrumentation data (such as logs and traces) are formatted on the host.
- The APIs are modularized so that only those APIs that are used by the program need to be bound into the executable program.
- The library is optimized to require the smallest possible number of instruction cycles, with a significant portion implemented in assembly language.
- Communication between the target and DSP/BIOS analysis tools is performed within the background idle loop. This ensures that DSP/BIOS analysis tools do not interfere with the program's tasks. If the target CPU is too busy to perform background tasks, the DSP/BIOS analysis tools stop receiving information from the target until the CPU is available.
- Error checking that would increase memory and CPU requirements has been kept to a minimum. Instead, the API reference documentation specifies constraints for calling API functions. It is the responsibility of the application developer to meet these constraints.

In addition, the DSP/BIOS API provides many options for program development:

- A program can dynamically create and delete objects that are used in special situations. The same program can use both objects created dynamically and objects created statically.

- The threading model provides thread types for a variety of situations. Hardware interrupts, software interrupts, tasks, idle functions, and periodic functions are all supported. You can control the priorities and blocking characteristics of threads through your choice of thread types.
- Structures to support communication and synchronization between threads are provided. These include semaphores, mailboxes, and resource locks.
- Two I/O models are supported for maximum flexibility and power. Pipes are used for target/host communication and to support simple cases in which one thread writes to the pipe and another reads from the pipe. Streams are used for more complex I/O and to support device drivers.
- Low-level system primitives are provided to make it easier to handle errors, create common data structures, and manage memory usage.

The DSP/BIOS API standardizes DSP programming for a number of TI devices and provides easy-to-use powerful program development tools. These tools reduce the time required to create DSP programs in the following ways:

- The Tconf configuration script generates code required to statically declare objects used within the program.
- The configuration detects errors earlier by validating properties before the program is built.
- Configuration scripts can be modified in a text editor to include branching, looping, testing of command-line arguments and more.
- Logging and statistics for DSP/BIOS objects are available at run-time without additional programming. Additional instrumentation can be programmed as needed.
- The DSP/BIOS analysis tools allow real-time monitoring of program behavior.
- DSP/BIOS provides a standard API. This allows DSP algorithm developers to provide code that can be more easily integrated with other program functions.
- DSP/BIOS is integrated within the Code Composer Studio IDE, requires no runtime license fees, and is fully supported by Texas Instruments. DSP/BIOS is a key component of TI's eXpressDSP™ real-time software technology.

1.1.1 What's New in DSP/BIOS 5.42?

- DSP/BIOS is installed as part of a Code Composer Studio v5.3 or higher installation.
- DSP/BIOS 5.42 cannot be used with CCS v3 or v4. (Use an older version of DSP/BIOS if you do not want to upgrade to the latest version of CCS.)
- XDCtools versions 3.25 and higher no longer provide support for the TCF configuration files used with DSP/BIOS. DSP/BIOS 5.42 has been updated to provide its own TCF configuration support, without the need for XDCtools.

1.2 DSP/BIOS Components

Figure 1–1 shows DSP/BIOS components within the program generation and debugging environment of Code Composer Studio:

Figure 1–1 DSP/BIOS Components

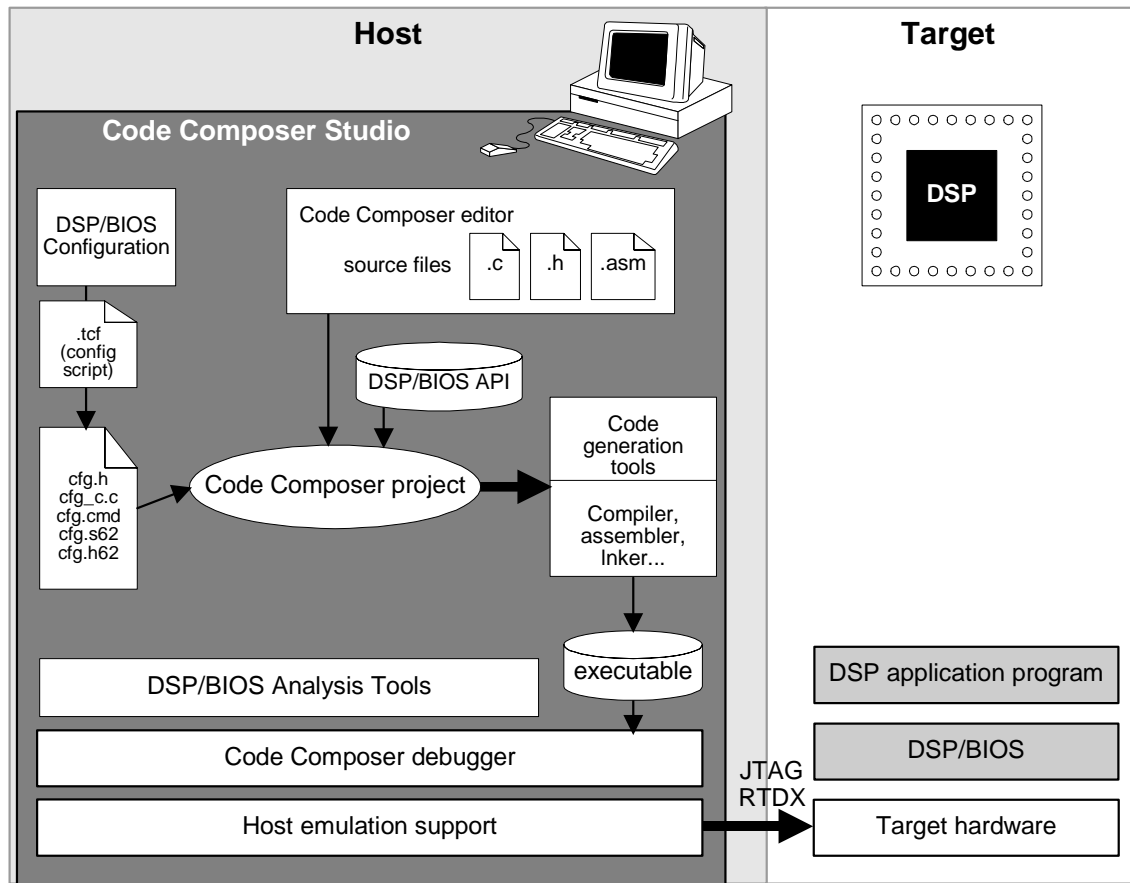

- **DSP/BIOS API.** On the host PC, you write programs (in C, C++, or assembly) that call DSP/BIOS API functions.
- **DSP/BIOS Configuration Tool.** You create a configuration that defines static objects to be used in your program. The configuration generates files that you compile and link with the program.
- **DSP/BIOS Analysis Tools.** These tools in Code Composer Studio let you test the program on the target device while monitoring CPU load, timing, logs, thread execution, and more. (*Thread* refers to any thread of execution: hardware interrupt, software interrupt, task, or idle function.)

The sections that follow provide an overview of these DSP/BIOS components.

1.2.1 DSP/BIOS Real-Time Kernel and API

DSP/BIOS is a scalable real-time kernel, designed for applications that require real-time scheduling and synchronization, host-to-target communication, or real-time instrumentation. DSP/BIOS provides preemptive multi-threading, hardware abstraction, real-time analysis, and configuration tools.

The DSP/BIOS API is divided into modules. Depending on what modules are configured and used by the application, the size of DSP/BIOS can range from about 500 to 6500 words of code. All the operations within a module begin with the letter codes shown Figure 1–1.

Application programs use DSP/BIOS by making calls to the API. All DSP/BIOS modules provide C-callable interfaces. Most C-callable interfaces can also be called from assembly language, provided that C calling conventions are followed. Some of the C interfaces are actually C macros and therefore, cannot be used when called from assembly language. Refer to the *TMS320 DSP/BIOS API Reference Guide* for your platform for details.

Table 1–1. DSP/BIOS Modules

Module	Description
ATM	Atomic functions written in assembly language
BUF	Fixed-length buffer pool manager
C28, C55, C62, C64	Target-specific functions, platform dependent
CLK	Clock manager
DEV	Device driver interface
GBL	Global setting manager
GIO	General I/O manager
HOOK	Hook function manager
HST	Host channel manager
HWI	Hardware interrupt manager
IDL	Idle function manager
LCK	Resource lock manager
LOG	Event log manager
MBX	Mailbox manager
MEM	Memory segment manager
MSGQ	Message queue manager
PIP	Buffered pipe manager
POOL	Allocator pool manager
PRD	Periodic function manager
PWRM	Power manager ('C55x and 'C6748 only)
QUE	Atomic queue manager
RTDX	Real-time data exchange settings
SEM	Semaphore manager
SIO	Stream I/O manager
STS	Statistics object manager
SWI	Software interrupt manager

Module	Description
SYS	System services manager
TRC	Trace manager
TSK	Multitasking manager

1.2.2 DSP/BIOS Configuration Tool

A DSP/BIOS configuration allows you to optimize your application by creating objects and setting their properties statically, rather than at run-time. This both improves run-time performance and reduces the application footprint.

The source file for a configuration is a DSP/BIOS Tconf script, which has a file extension of .tcf. There are two ways to access a DSP/BIOS configuration:

- Textually.** You can edit the text of the script using Code Composer Studio or a separate text editor. You code the configuration using JavaScript syntax. See the *DSP/BIOS Textual Configuration (Tconf) User's Guide* (SPRU007) for details.
- Graphically.** You can view configurations in read-only mode with the DSP/BIOS Configuration Tool, a graphical editor that functions as a macro recorder for scripts. The interface is similar to that of the Windows Explorer. The script is shown in the right pane as you create it.

```
prog.module["SWI"].create("encoder");
prog.module["SWI"].create("decoder");
```

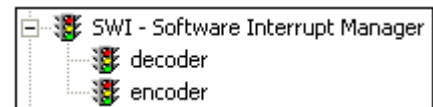

You can set a wide range of parameters used by DSP/BIOS at run time. The objects you create are used by the application's DSP/BIOS API calls. These objects include software interrupts, tasks, I/O streams, and event logs.

Figure 1–2 Configuration Tool Module Tree

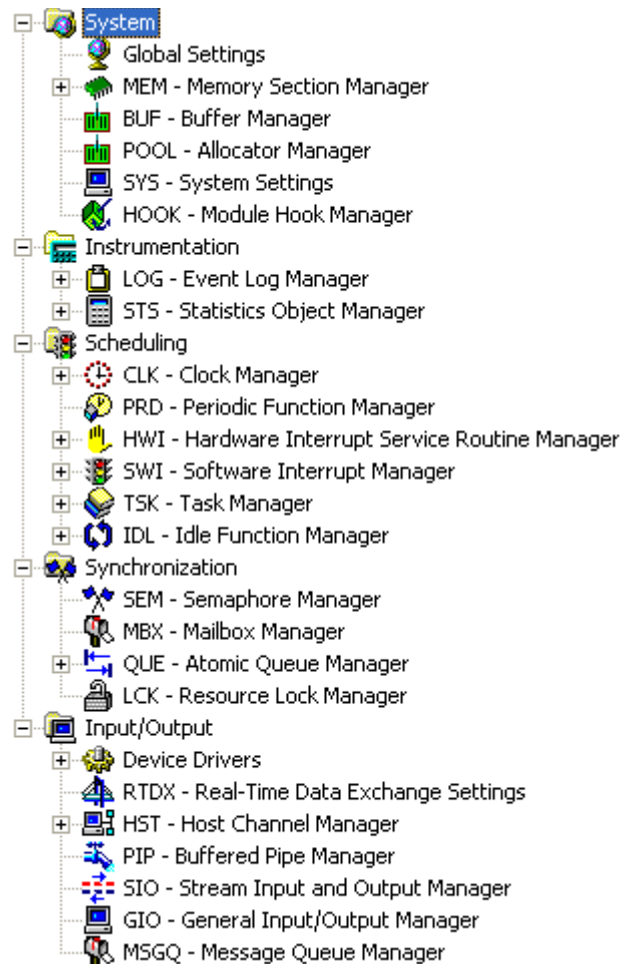

When you save a configuration, Tconf generates files to be included in the project. Using static configuration, DSP/BIOS objects can be pre-configured and bound into an executable program image. Alternately, a DSP/BIOS program can create and delete certain objects at run time.

In addition to minimizing the target memory footprint by eliminating run-time code and optimizing internal data structures, creating static objects detects errors earlier by validating object properties before program compilation.

See the DSP/BIOS online help and Section 2.5, *Configuring DSP/BIOS Applications Statically*, page 2-33, for details.

1.2.3 DSP/BIOS Analysis Tools

The DSP/BIOS analysis tools complement the Code Composer Studio environment by enabling real-time program analysis of a DSP/BIOS application. You can visually monitor a DSP application as it runs with minimal impact on the application's real-time performance.

In CCS, the DSP/BIOS analysis tools are found in the **Tools > RTOS Analyzer > RTA (Legacy)** menu, as shown here.

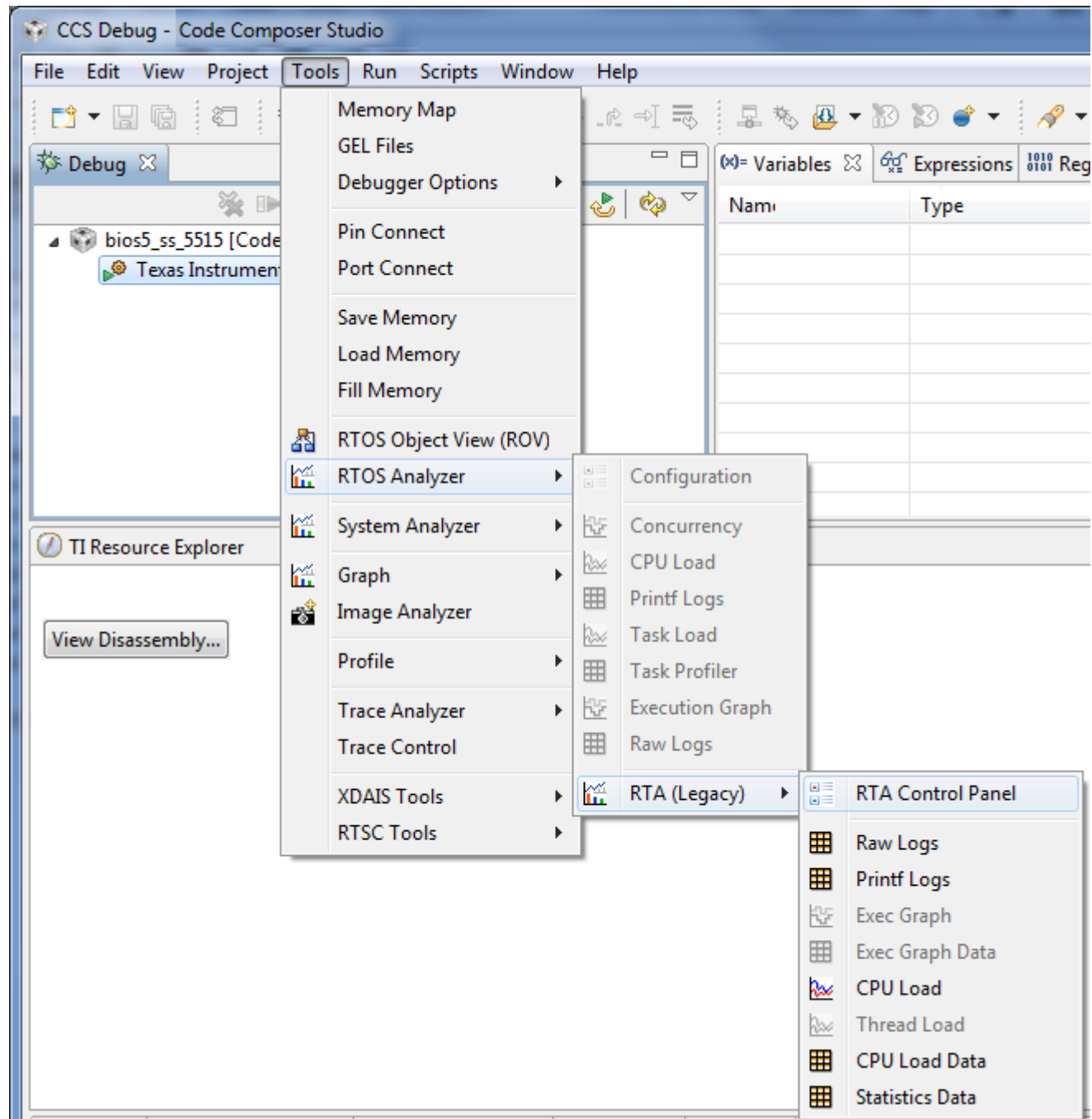

See the DSP/BIOS online help and Chapter 3, *Instrumentation* for details about individual analysis tools.

Unlike traditional debugging, which is external to the executing program, program analysis requires the target program contain real-time instrumentation services. By using DSP/BIOS APIs and objects, developers automatically instrument the target for capturing and uploading real-time information to the host through the Code Composer Studio DSP/BIOS analysis tools.

Several broad real-time program analysis capabilities are provided:

- **Program tracing.** Displaying events written to target logs, reflecting dynamic control flow during program execution
- **Performance monitoring.** Tracking summary statistics that reflect use of target resources, such as processor load and timing
- **File streaming.** Binding target-resident I/O objects to host files

When used in tandem with other debugging capabilities of Code Composer Studio, the DSP/BIOS real-time analysis tools provide critical views into target program behavior during program execution—where traditional debugging techniques that stop the target offer little insight. Even after the debugger halts the program, information already captured by the host with the DSP/BIOS analysis tools can provide insight into the sequence of events that led up to the current point of execution

Later in the software development cycle, when regular debugging techniques become ineffective for attacking problems arising from time-dependent interactions, the DSP/BIOS analysis tools have an expanded role as the software counterpart of the hardware logic analyzer.

1.3 Naming Conventions

Each DSP/BIOS module has a unique name that is used as a prefix for operations (functions), header files, and objects for the module. This name is comprised of 3 or more uppercase alphanumerics.

Throughout this manual, 64 represents the two-digit numeric appropriate to your specific DSP platform. If your DSP platform is C6200 based, substitute 62 each time you see the designation 64. For example, DSP/BIOS assembly language API header files for the C6000 platform will have a suffix of .h62. For a C55x DSP platform, substitute 55 for each occurrence of 64. Also, each reference to Code Composer Studio C5000 can be substituted with Code Composer Studio C6000.

All identifiers beginning with upper-case letters followed by an underscore (XXX_*) should be treated as reserved words.

1.3.1 Module Header Names

Each DSP/BIOS module has two header files containing declarations of all constants, types, and functions made available through that module's interface.

- **xxx.h.** DSP/BIOS API header files for C programs. Your C source files should include std.h and the header files for any modules the C functions use.
- **xxx.h##.** DSP/BIOS API header files for assembly programs. Assembly source files should include the appropriate xxx.h## header file for any module the assembly source uses. For example, hwi.h62. This file contains macro definitions specific to this device.

Your program must include the header file for each module used in a particular program source file. In addition, C source files must include `std.h` before any module header files. (See Section 1.3.4, *Data Type Names*, page 1-21, for more information.) The `std.h` file contains definitions for standard types and constants. After including `std.h`, you can include the other header files in any sequence. For example:

```
#include <std.h>
#include <tsk.h>
#include <sem.h>
#include <prd.h>
#include <swi.h>
```

DSP/BIOS includes a number of modules that are used internally. These modules are undocumented and subject to change at any time. Header files for these internal modules are distributed as part of DSP/BIOS and must be present on your system when compiling and linking DSP/BIOS programs.

1.3.2 Object Names

System objects included in the configuration by default typically have names beginning with a 3- or 4-letter code for the module that defines or uses the object. For example, the default configuration includes a LOG object called `LOG_system`.

Note: Objects you create statically should use a common naming convention of your choosing. You might want to use the module name as a suffix in object names. For example, a TSK object that encodes data might be called `encoderTsk`.

1.3.3 Operation Names

The format for a DSP/BIOS API operation name is `MOD_action` where `MOD` is the letter code for the module that contains the operation, and `action` is the action performed by the operation. For example, the `SWI_post` function is defined by the `SWI` module; it posts a software interrupt.

This implementation of the DSP/BIOS API also includes several built-in functions that are run by various built-in objects. Here are some examples:

- **CLK_F_isr.** Run by an HWI object to provide the low-resolution CLK tick.
- **PRD_F_tick.** Run by the `PRD_clock` CLK object to manage `PRD_SWI` and system tick.
- **PRD_F_swi.** Triggered by `PRD_tick` to run the PRD functions.
- **_KNL_run.** Run by the lowest priority SWI object, `KNL_swi`, to run the task scheduler if it is enabled. This is a C function called `KNL_run`. An underscore is used as a prefix because the function is called from assembly code.
- **_IDL_loop.** Run by the lowest priority TSK object, `TSK_idle`, to run the IDL functions.
- **IDL_F_busy.** Run by the `IDL_cpuLoad` IDL object to compute the current CPU load.
- **RTA_F_dispatch.** Run by the `RTA_dispatcher` IDL object to gather real-time analysis data.
- **LNK_F_dataPump.** Run by the `LNK_dataPump` IDL object to manage the transfer of real-time analysis and HST channel data to the host.
- **HWI_unused.** Not actually a function name. This string is used in the configuration to mark unused HWI objects.

Note: Your program code should not call any built-in functions whose names begin with MOD_F_. These functions are intended to be called only as function parameters specified in the configuration.

Symbol names beginning with MOD_ and MOD_F_ (where MOD is any letter code for a DSP/BIOS module) are reserved for internal use.

1.3.4 Data Type Names

The DSP/BIOS API does not explicitly use the fundamental types of C such as int or char. Instead, to ensure portability to other processors that support the DSP/BIOS API, DSP/BIOS defines its own standard data types. In most cases, the standard DSP/BIOS types are uppercase versions of the corresponding C types.

The data types, shown in Table 1–2, are defined in the std.h header file.

Table 1–2. DSP/BIOS Standard Data Types:

Type	Description
Arg	Type capable of holding both Ptr and Int arguments
Bool	Boolean value
Char	Character value
Fxn	Pointer to a function
Int	Signed integer value
LgInt	Large signed integer value
LgUns	Large unsigned integer value
Ptr	Generic pointer value
String	Zero-terminated (\0) sequence (array) of characters
Uns	Unsigned integer value
Void	Empty type

Additional data types are defined in std.h, but are not used by DSP/BIOS APIs.

In addition, the standard constant NULL (0) is used by DSP/BIOS to signify an empty pointer value. The constants TRUE (1) and FALSE (0) are used for values of type Bool.

Object structures used by the DSP/BIOS API modules use a naming convention of MOD_Obj, where MOD is the letter code for the object's module. If your program code uses any such objects created in the configuration, it should make an extern declaration for the object. For example:

```
extern LOG_Obj trace;
```

Running the configuration script automatically generates a C header to file that contains the appropriate declarations for all DSP/BIOS objects created by the configuration (<program>.cfg.h). This file should be included by the application's source files to declare DSP/BIOS objects.

1.3.5 Memory Segment Names

The memory segment names used by DSP/BIOS are described in Table 1–3. You can change the origin, size, and name of most default memory segments in the configuration.

Table 1–3. Memory Segment Names

Memory Segment Names, C55x Platform



Segment	Description
IDATA	Primary block of data memory
DATA1	Secondary block of data memory (not contiguous with DATA)
PROG	Program memory
VECT	DSP Interrupt vector table memory segment

Memory Segment Names, C6000 EVM Platform



Segment	Description
IPRAM	Internal (on-device) program memory
IDRAM	Internal (on-device) data memory
SBSRAM	External SBSRAM on CE0
SDRAM0	External SDRAM on CE2
SDRAM1	External SDRAM on CE3

Memory Segment Names, C6000 DSK Platform



Segment	Description
SDRAM	External SDRAM

Memory Segment Names, C2800 DSK Platform



Segment	Description
BOOTROM	Boot code memory
FLASH	Internal flash program memory
VECT	Interrupt vector table when VMAP=0
VECT1	Interrupt vector table when VMAP=1
OTP	One time programmable memory via flash registers
H0SARAM	Internal program RAM
L0SARAM	Internal data RAM
M1SARAM	Internal user and task stack RAM

1.3.6 Standard Memory Sections

The configuration defines standard memory sections and their default allocations as shown in Table 1–4. You can change these default allocations using the MEM Manager. For more detail, see *MEM Module* in the *TMS320 DSP/BIOS API Reference Guide* for your platform.

Table 1–4. Standard Memory Segments

C55x Platform



Sections	Segment
System stack Memory (.stack), System Stack Memory (.sysstack)	DATA
BIOS Kernel State Memory (.sysdata)	DATA
BIOS Objects, Configuration Memory (*.obj)	DATA
BIOS Program Memory (.bios)	PROG
BIOS Startup Code Memory (.sysinit, .gblinit, .trcinit)	PROG
Application Argument Memory (.args)	DATA
Application Program Memory (.text)	PROG
BIOS Heap Memory	DATA
Secondary BIOS Heap Memory	DATA1

C6000 Platform



Sections	Segment
System stack memory (.stack)	IDRAM
Application constants memory (.const)	IDRAM
Program memory (.text)	IPRAM
Data memory (.data)	IDRAM
Startup code memory (.sysinit)	IPRAM
C initialization records memory (.cinit)	IDRAM
Uninitialized variables memory (.bss)	IDRAM

C2800 Platform

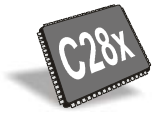

Sections	Segment
System stack memory (.stack)	M1SARAM
Program memory (.text)	I PROG
Data memory (.data)	IDATA
Applications constants memory (.const)	IDATA
Startup code memory (.sysinit)	I PROG
C initialization records memory (.cinit)	IDATA
Uninitialized variables memory (.bss)	IDATA

1.4 For More Information

For more information about the components of DSP/BIOS and the modules in the DSP/BIOS API, see the *DSP/BIOS* section of the online help system, or the *TMS320 DSP/BIOS API Reference Guide* for your platform.

Program Generation

This chapter describes the process of generating programs with DSP/BIOS. It also explains which files are generated by DSP/BIOS components and how they are used.

Topic	Page
2.1 Using DSP/BIOS in CCS Projects	26
2.2 Using the DSP/BIOS Configuration Tool.	31
2.3 How hello.c Uses DSP/BIOS.	32
2.4 The Development Cycle	33
2.5 Configuring DSP/BIOS Applications Statically.	33
2.6 Creating DSP/BIOS Objects Dynamically	37
2.7 Files Used to Create DSP/BIOS Programs	39
2.8 Using Makefiles to Build Applications	40
2.9 Using DSP/BIOS with the Run-Time Support Library	42
2.10 DSP/BIOS Startup Sequence	43
2.11 Using C++ with DSP/BIOS	45
2.12 User Functions Called by DSP/BIOS	47
2.13 Calling DSP/BIOS APIs from Main	47

2.1 Using DSP/BIOS in CCS Projects

The following sections explain how to create and work with projects in Code Composer Studio that use DSP/BIOS.

2.1.1 Creating a CCS Project for DSP/BIOS Applications

To create a new CCS project that uses DSP/BIOS, follow these steps.

1. Open CCS and choose **File > New > CCS Project** from the menu bar.
2. In the New CCS Project dialog, type a **Project name**. For example, to begin creating a project using "hello world" example code provided with DSP/BIOS, you can type "hellobios5". The default project location is a folder with the same name as the project in your current workspace.

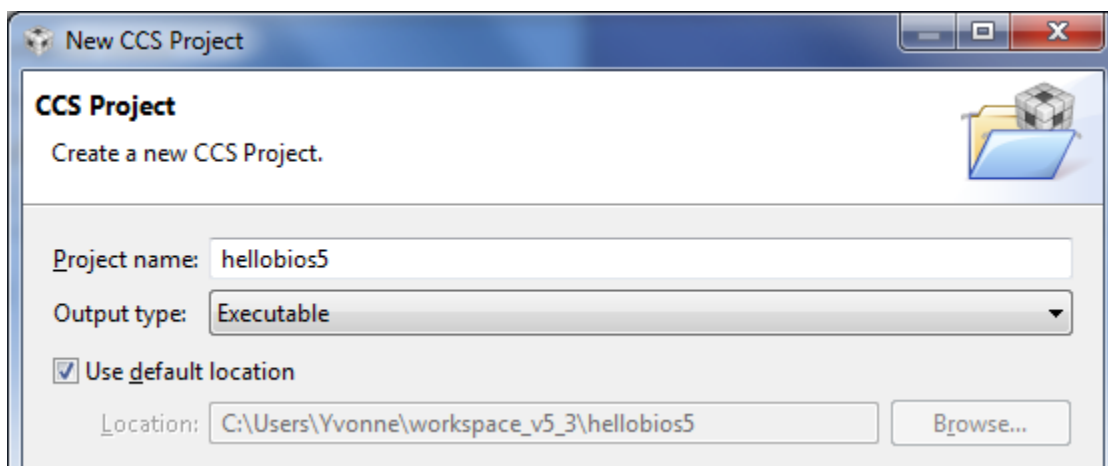

3. In the **Family** drop-down field, select your platform type. For example, you might select "C2000", "C5500", or "C6000".
4. In the **Variant** row, select or type a filter on the left. This shortens the list of device variants in the right drop-down field. Then, select the actual device you are using. For example, you might select "Generic devices" in the filter field and "Generic C64x+ Device" in the second field.
5. In the **Connection** drop-down field, select how you connect to the device. The choices depend on the device you selected; typically you can choose the Data Snapshot Viewer, a simulator, or an emulator.

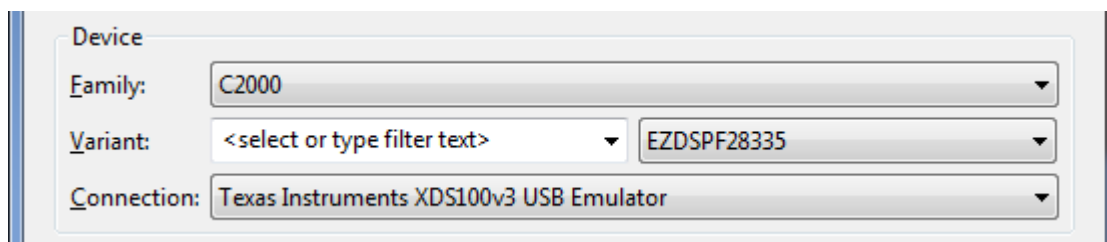

- If you need to use a non-default setting for the device endianness, the TI Code Generation Tools version, the output format (COFF or ELF), or the Runtime support library, click the arrow next to the **Advanced settings** label to display fields for those settings. Typically, you will not need to do this.

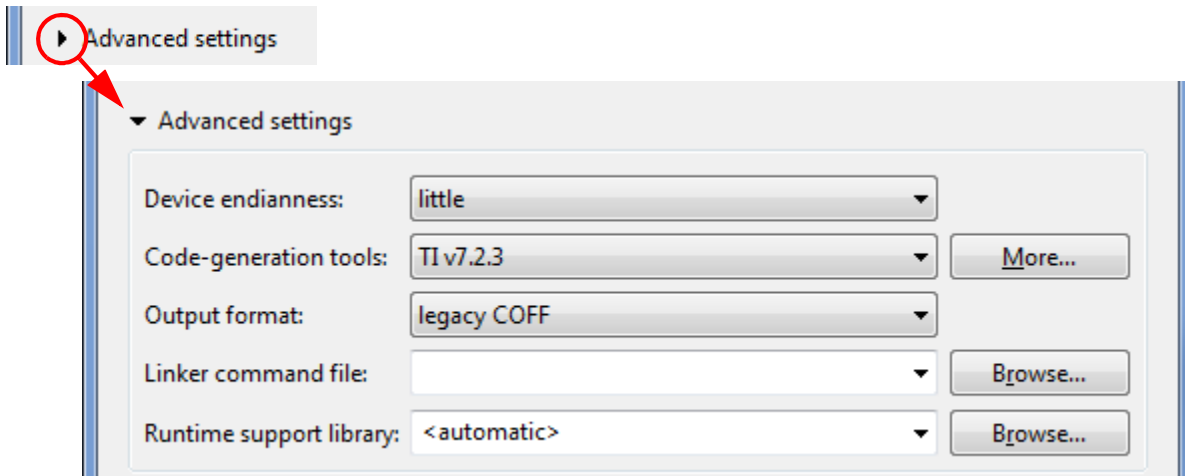

Note: You should not specify your own linker command file when you are getting started using DSP/BIOS. A linker command file will be created and used automatically when you build the project.

- In the **Project templates** area, scroll down to the **DSP/BIOS v5.xx Examples** item and expand the list of devices. Select your device and then an example for that device. A description of the selected template is shown to the right of the template list.

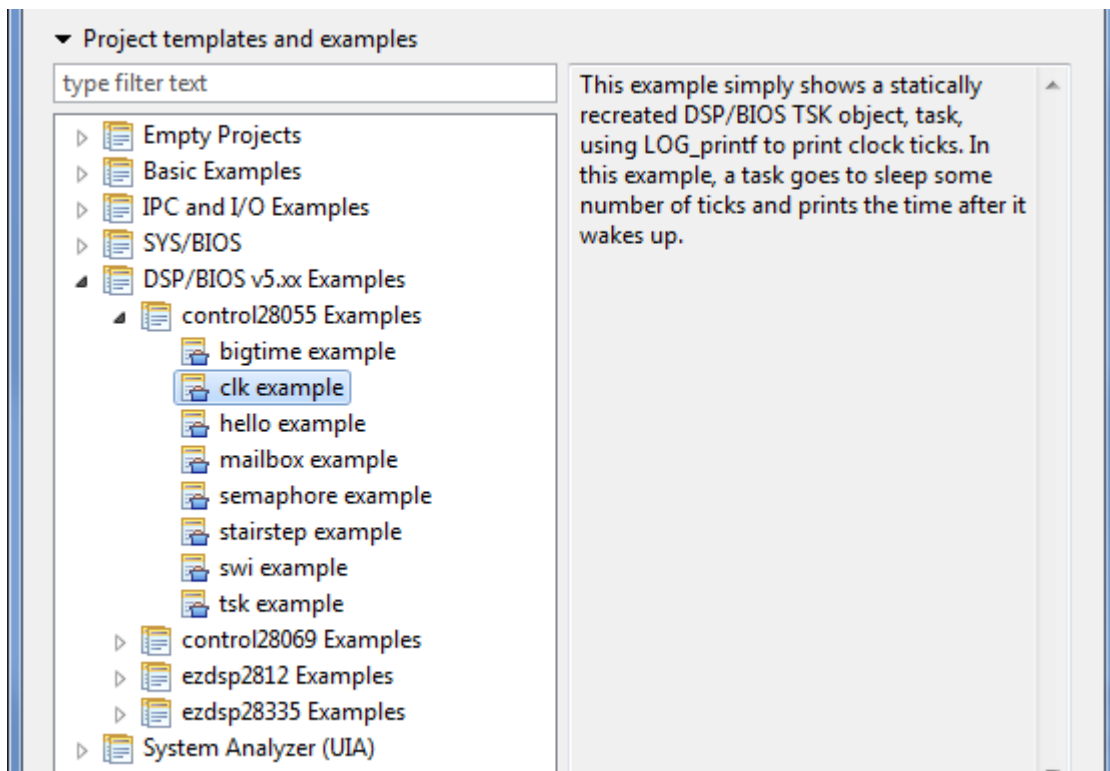

2.1.2 Adding a DSP/BIOS Configuration to an Existing Project

If you want to use the DSP/BIOS APIs in a project, that project needs to have a DSP/BIOS Configuration file (.tcf). You can add this type of file to an existing project as follows:

1. Choose **File > New > DSP/BIOS v5.xx Configuration**.
2. Click **Browse** next to the Project field, and select the CCS project to which you want to add DSP/BIOS support. Click **OK**.
3. Change the **Filename** to match your project name (if it doesn't already match). For example, if your project name is "helloworld5", change the configuration filename to helloworld5.tcf. Click **Next**.
4. Select a platform for the configuration from the list. You can type a filter—for example, 64—to shorten the list. Click **Next**.
5. In the list of DSP/BIOS Features, you can disable features if you are sure you won't want to use them. Disabling features reduces the application's code size, but limits functionality. Then, click **Finish**.

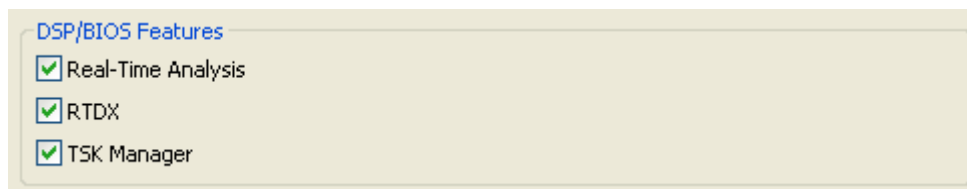

- **Real-Time Analysis.** Disabling this feature prevents the gathering of LOG, STS, and other instrumentation data from the target. See Section 3.1.
 - **RTDX.** Real-Time Data eXchange provides for target-host communication. If you disable RTDX, you will not be able to view real-time analysis (RTA) data. The ROV tool provides stop-mode access to data, and is supported even if RTDX is disabled. See Section 3.8.
 - **TSK Manager.** Tasks are threads that allow yielding and can use thread synchronization objects such as semaphores. Most applications use tasks, but some may only use hardware and software interrupts. See Section 4.4.
6. After you click **Finish**, the DSP/BIOS Configuration Tool opens. In the Configuration Tool window, perform any tasks required by your application. See Section 2.2 for details on performing these tasks.
 7. Save the configuration by choosing **File > Save** or clicking the Save icon. You can close the DSP/BIOS Configuration Tool at this point, but can always return later to make further changes.

2.1.2.1 Notes for Adding DSP/BIOS to Existing Projects

If your project previously had its own linker command file, you may want to remove the old linker command file from the project or use both linker command files. In a DSP/BIOS application, programcfg.cmd is your project's linker command file. This file already includes directives for the linker to use the appropriate libraries (e.g., bios.a62, rtdx.lib, rts64plus.lib), so you do not need to add any of these library files to your project.

For most DSP/BIOS applications the generated linker command file, programcfg.cmd, suffices to describe all memory segments and allocations. All DSP/BIOS memory segments and objects are handled by this linker command file. In addition, most commonly used sections (such as .text, .bss, .data, etc.) are already included in programcfg.cmd. Their locations (and sizes, when appropriate) can be controlled from the MEM Manager in the configuration. In some cases an application can require an additional linker command file (app.cmd) to describe application-specific sections that are not described in the linker command file generated by the configuration.

If your project includes the `vectors.asm` source file, you should remove that file from the project. Hardware interrupt vectors are automatically defined in the DSP/BIOS configuration.

Code Composer Studio software automatically scans all dependencies in your project files, adding the necessary DSP/BIOS and RTDX header files for your configuration to your project's include folder. So, you don't need to explicitly add DSP/BIOS header files to the project.

2.1.3 Adding a Source File to a CCS Project

Add a C source file to your DSP/BIOS project in one of the following ways:

- You can create a new file by choosing **File > New > Source File**.
- You can add an existing file to your project by choosing **Project > Add Files** (copies the file to your workspace) or **Project > Link Files to Active Project** (does not copy the file; uses the original location).

For example, you might choose **Project > Add Files** and browse to the `C:\ti\bios_5_##_##_##\packages\ti\bios\examples` directory to add the `hello.c` file. See Section 2.3 for a brief overview of how `hello.c` uses DSP/BIOS.

Note that the provided examples expect specific filenames for the DSP/BIOS Configuration File. For example, `hello.c` #includes `hellocfg.h`, which would be generated from a configuration file called `hello.tcf`. If your configuration file has a different name, you should modify the #include statement. For example, if your configuration file is `helloworld5.tcf`, modify the `hello.c` file to #include the `helloworld5cfg.h` file.

2.1.4 Create a CCS Target Configuration File

Create a target configuration for CCS project to use when debugging as follows:

1. Choose **File > New > Target Configuration File**.
2. Type a filename for the target configuration, which will be stored as part of the CCS project. For example, you might type `TCI6482sim.ccxml` if that reflects the target you want to use. Then, click **Finish**.
3. In the **Connection** field for your target configuration, choose the type of connection you have to the target.
4. Type part of the target name in the **Device** filter field. For example, you might choose the "TI Simulator" connection and filter by "64xp" to find a C64x+ simulator.
5. Check the box next to your target.
6. Choose **File > Save** or click the **Save** button to save your target configuration.

2.1.5 Build a DSP/BIOS Project

Build your DSP/BIOS project as follows:

1. Choose **Project > Build Active Project**.
2. Examine the log in the Console tab to diagnose any errors. Notice that when you build, the DSP/BIOS Configuration .tcf file is processed to generate a number of files that are listed in the Debug node of the project list.

2.1.6 Run a DSP/BIOS Project

Run an application as follows:

1. Choose **Run > Debug** or click the Debug icon. This causes CCS to switch to the CCS Debug perspective. Your application runs and halts before the first statement in main().
2. Set breakpoints by double-clicking in the margin next to lines where you want to stop. For example, in hello.c you might set a breakpoint on the `return;` line.
3. Choose **Tools > RTOS Object View (ROV)** to open a view that allows you to view the state of objects created with DSP/BIOS.
4. Expand the hierarchy in the ROV tool so you can select the "trace" LOG.

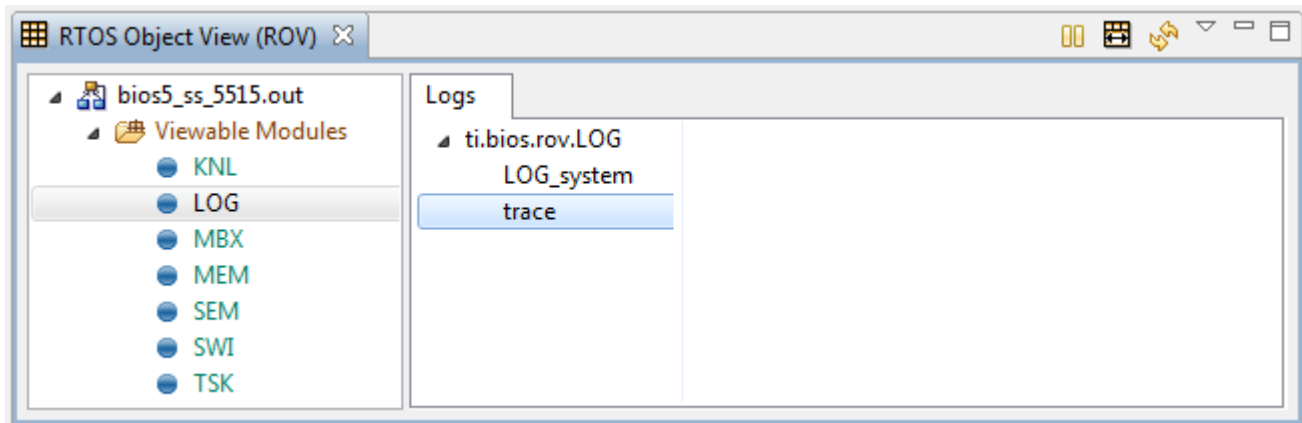

5. Choose **Target > Run** or click the Run icon to run to the breakpoint.
6. The information for the "trace" LOG should now show the message sent by LOG_printf.
7. See Section 3.3 for more information about using the ROV tool. See Section 3.2 for information about using Real-Time Analysis tools for debugging.

2.1.7 Converting Legacy CCS Projects to CCS 5.x Projects

To import a CCSv3.3 project, choose **Project > Import Legacy CCSv3.3 Project** in CCS. Follow the instructions in the import wizard.

To import a CCSv4 or CCSv5 project, choose **Project > Import Existing CCS Eclipse Project**. Follow the instructions in the import wizard.

For more information about converting legacy projects to CCS v5.x projects, go to http://processors.wiki.ti.com/index.php/Migrating_to_CCSv5.

If you are importing a project that uses DSP/BIOS, the wizard asks you to select the version of DSP/BIOS you want the imported project to use. It is recommended that you select a DSP/BIOS 5.4x version. This version of DSP/BIOS is compatible with previous 5.x versions.

If you select a SYS/BIOS 6.x version, you will need to make changes to your source code and configuration. (See the documentation for SYS/BIOS instead of DSP/BIOS.)

2.2 Using the DSP/BIOS Configuration Tool

The DSP/BIOS Configuration Tool lets you configure the modules that make up the DSP/BIOS kernel. The modules are shown in the left pane of the tool.

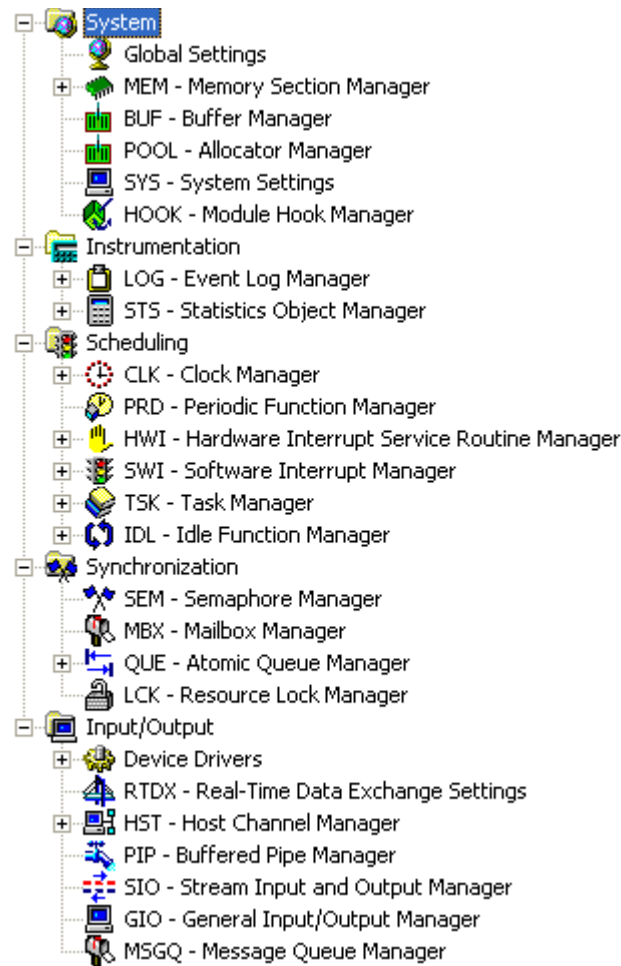

Modules have a manager, for which you can set properties. In addition, most modules let you create object instances, for which you can set properties.

In the DSP/BIOS Configuration Tool, you can perform the following actions:

- Create and name objects. See Section 2.2.1.
- Set global properties for the application, module manager properties, and object properties. See Section 2.2.2.
- Set priorities for software interrupts and tasks. See Section 2.2.3.
- Add comments and blank lines to the script. See Section 2.2.4.

2.2.1 **Creating Objects in the Configuration Tool**

To create a new object with the Configuration Tool, follow these steps:

1. Select the manager for the object type you want to create. For example, if you want to create an SWI object, select the SWI manager.
2. Choose **Object > Insert** or right-click and choose **Insert**.
3. Type a name for the new object in the Insert Object dialog.

2.2.2 **Setting Properties in the Configuration Tool**

To set properties for a module or object, follow these steps:

1. Select the manager or object whose properties you want to set and choose **Object > Properties** or right-click and choose **Properties**. Global properties for the configuration are in the System category.
2. In the Properties dialog, change the property settings as desired. Items with a large number of properties have the tabs that contain various categories of properties. For context-sensitive help about properties, click **Help** in any Properties dialog.
3. When you have finished setting properties, click **OK**.

2.2.3 **Setting Priorities in the Configuration Tool**

You can set priority levels for SWI or TSK object. Likewise, you can set the execution order of CLK, PRD, IDL, and HOOK objects. To set such priorities or execution orders, follow these steps:

1. In the Configuration Tool, highlight the manager whose priorities or order you want to set.
2. Notice that the objects in the middle pane of the window are listed by priority or execution order. (If you do not see the priority list in the right half of the window, right-click on the manager and choose **Ordered collection view** from the menu.)
3. Drag objects to the priority levels or execution order you want to use.

2.2.4 **Modifying the Script in the Configuration Tool**

The right pane of the Configuration Tool shows the current .tcf script. As you make changes to objects and properties, the statements that create that configuration are shown in the right pane. You can modify the script slightly by clicking on a location in the script and choosing **Insert Comment** or **Insert Blank Line**. If you want to make more substantial changes to the text of the script, you can use CCS to open the *.tcf file with a Text Editor.

2.3 **How hello.c Uses DSP/BIOS**

The hello.c program uses DSP/BIOS's LOG module to send a message to the host.

The first few lines include the header files for DSP/BIOS modules used in this file. In DSP/BIOS programs, always include the std.h file first, then include the module header files. This example uses the LOG module, so that header file is also included.

```
#include <std.h>
#include <log.h>
```

The program must also include the header file that will be generated from the .tcf configuration file. This file has the filename <tcf_file>cfg.h. For example, if the .tcf file for a project is hello.tcf, the #include statement would be as follows:

```
#include "hellocfg.h"
```

The main() function simply prints a message to a log using the LOG_printf API. This API is very efficient. To reduce execution time, LOG_printf just passes raw data to the host PC; formatting is done on the PC.

```
/* ===== main ===== */  
Void main()  
{  
    LOG_printf(&trace, "hello world!");
```

After the main() function is complete, it returns. In more complicated applications, the return statement has the effect of turning control over to DSP/BIOS scheduling to run hardware interrupts (HWI), software interrupts (SWI), tasks (TSK), and idle functions (IDL) as needed.

```
/* fall into DSP/BIOS idle loop */  
return;
```

2.4 The Development Cycle

DSP/BIOS supports iterative program development cycles. You can create the basic framework for an application and test it with a simulated processing load before the DSP algorithms are in place. You can easily change the priorities and types of program threads that perform various functions.

A sample DSP/BIOS development cycle includes the following steps, though iteration can occur for any step or group of steps:

1. Configure static objects for your program to use. This can be done using the DSP/BIOS Configuration Tool or the Tconf scripting language.
2. Write a framework for your program. You can use C, C++, assembly, or a combination of the languages.
3. Add files to your project and compile and link the program using Code Composer Studio.
4. Test program behavior using a simulator or initial hardware and the DSP/BIOS analysis tools. You can monitor logs and traces, statistics objects, timing, software interrupts, and more.
5. Repeat steps 1-4 until the program runs correctly. You can add functionality and make changes to the basic program structure.
6. When production hardware is ready, modify the configuration to support the production board and test your program on the board.

2.5 Configuring DSP/BIOS Applications Statically

As Section 1.2.2, *DSP/BIOS Configuration Tool*, page 1-16 describes, DSP/BIOS configurations allow you create objects and set their properties statically, rather than at run-time. You can choose to create a configuration graphically, textually, or using a combination of these methods.

The *DSP/BIOS Textual Configuration (Tconf) User's Guide* (SPRU007) contains details on the syntax used in configuration scripts.

2.5.1 **When to Use Graphical Configuration**

Use the DSP/BIOS Configuration Tool for the following advantages:

- If you want a tree-view interface that makes it easy to see the available properties for each module and object.
- If you want to be prevented from making errors by the interface, which provides drop-down lists of valid values and disables invalid commands and fields.

You can use a text editor to modify a configuration script and then reload the script into the DSP/BIOS Configuration Tool for further graphical editing. There are certain restrictions on graphical editing after you have edited a script or started a new configuration session.

2.5.2 **When to Use a Text Editor**

Use a text editor to modify a script if you want the following advantages:

- If you want a script to use branching, looping, and other constructs.
- If you want to create a number of similar objects. You can do this with cut-and-paste or by looping over a create method.
- If you want to modularize settings you use in a set of applications. For example, if your applications all use similar instrumentation objects, all applications can include a single file that creates those objects.
- If you want the configuration to use the same symbol definitions as program source files. You can do this by defining variables for use in scripts and generating a C header file from the script to be included by the program source code.
- If you want to create similar configurations, you can pass command-line arguments to a script. For example, you might optimize a program by varying the number of tasks created and testing resulting applications.
- If you want to use standard code editing tools. For example, to merge changes from multiple developers, compare application configurations, and cut and paste between program configurations.
- If you want to use UNIX.

DSP/BIOS configurations should not be confused with other items used for configuration within Code Composer Studio.

2.5.3 **Referencing Statically Created DSP/BIOS Objects**

Statically-created objects that you reference in a program need to be declared as extern variables outside all function bodies. For example, the following declarations make the PIP_Obj object visible in all functions that follow its definition in the program.

```
extern far  PIP_Obj inputObj;      /* C6000 devices */
    or
extern      PIP_Obj inputObj;      /* C5000 and C2800 devices */
```

The configuration generates a file that contains these declarations. The file has a name of the form *cfg.h, where * is the name of your program. This file can be #included in C files that reference DSP/BIOS objects.

2.5.3.1 Small and Large Model Issues for C6000



Although DSP/BIOS itself is compiled using the small model, you can compile DSP/BIOS applications using either the C6000 compiler's small model or any variation of the large model. (See the *TMS320C6000 Optimizing Compiler User's Guide (SPRU187G)*.) In fact, you can mix compilation models within the application code provided all global data that is accessed by using a displacement relative to B14 is placed no more than 32K bytes away from the beginning of the .bss section.

DSP/BIOS uses the .bss section to store global data. However, objects configured statically are not placed in the .bss section. This maximizes your flexibility in the placement of application data. For example, the frequently accessed .bss can be placed in on-device memory while larger, less frequently accessed objects can be stored in external memory.

The small model makes assumptions about the placement of global data in order to reduce the number of instruction cycles. If you are using the small model (the default compilation mode) to optimize global data access, your code can be modified to make sure that it references statically-created objects correctly.

There are four methods for dealing with this issue. These methods are described in the sections following and have the pros and cons as shown in Table 2–1.

Table 2–1. Methods of Referencing C6000 Global Objects

Method	Declare objects with far	Use global object pointers	Objects adjacent to .bss	Compile with large model
Code works independent of compilation model	Yes	Yes	Yes	Yes
Code works independent of object placement	Yes	Yes	No	Yes
C code is portable to other compilers	No	Yes	Yes	Yes
Statically-created object size not limited to 32K bytes	Yes	Yes	No	Yes
Minimizes size of .bss	Yes	Yes	No	Yes
Minimizes instruction cycles	No (3 cycles)	No (2-6 cycles)	Yes (1 cycle)	No (3 cycles)
Minimizes storage per object	No (12 bytes)	No (12 bytes)	Yes (4 bytes)	No (12 bytes)
Easy to program; easy to debug	Somewhat	Error prone	Somewhat	Yes

2.5.3.2 Referencing Static DSP/BIOS Objects in the Small Model



In the small model, all compiled code accesses global data relative to a data page pointer register. The register B14 is treated as a read-only register by the compiler and is initialized with the starting address of the .bss section during program startup. Global data is assumed to be at a constant offset from the beginning of the .bss section and this section is assumed to be at most 32K bytes in length. Global data, therefore, can be accessed with a single instruction like the following:

```
LDW  *+DP(_x), A0    ; load _x into A0 (DP = B14)
```

Since objects created statically are not placed in the .bss section, you must ensure that application code compiled with the small model references them correctly. There are three ways to do this:

- Declare static objects with the far keyword. The DSP/BIOS compiler supports this common extension to the C language. The far keyword in a data declaration indicates that the data is not in the .bss section.

For example, to reference a PIP object called inputObj that was created statically, declare the object as follows:

```
extern far PIP_Obj inputObj;
if (PIP_getReaderNumFrames(&inputObj)) {
    . . .
}
```

- Create and initialize a global object pointer. You can create a global variable that is initialized to the address of the object you want to reference. All references to the object must be made using this pointer, to avoid the need for the far keyword. For example:

```
extern PIP_Obj inputObj;
/* input MUST be a global variable */
PIP_Obj *input = &inputObj;
if (PIP_getReaderNumFrames(input)) {
    . . .
}
```

Declaring and initializing the global pointer consumes an additional word of data (to hold the 32-bit address of the object).

Also, if the pointer is a static or automatic variable this technique fails. The following code does not operate as expected when compiled using the small model:

```
extern PIP_Obj inputObj;
static PIP_Obj *input = &inputObj; /* ERROR!!!! */
if (PIP_getReaderNumFrames(input)) {
    . . .
}
```

- Place all objects adjacent to .bss. If all objects are placed at the end of the .bss section, and the combined length of the objects and the .bss data is less than 32K bytes, you can reference these objects as if they were allocated within the .bss section:

```
extern PIP_Obj inputObj;
if (PIP_getReaderNumFrames(&inputObj)) {
    . . .
}
```

You can guarantee this placement of objects by using the configuration as follows:

- Declare a new memory segment by creating a MEM object and setting its properties (i.e., the base and length); or use one of the preexisting data memory MEM objects.
- Place all objects that are referenced by small model code in this memory segment.
- Place Uninitialized Variables Memory (.bss) in this same segment.

2.5.3.3 Referencing Static DSP/BIOS Objects in the Large Model



In the large model, all compiled code accesses data by first loading the entire 32-bit address into an address register and then using the indirect addressing capabilities of the LDW instruction to load the data. For example:

```
MVKL    _x, A0      ; move low 16-bits of _x's address into A0
MVKH    _x, A0      ; move high 16-bits of _x's address into A0
LDW     *A0, A0     ; load _x into A0
```

Application code compiled with any of the large model variants is not affected by the location of static objects. If all code that directly references statically-created objects is compiled with any large model option, code can reference the objects as ordinary data:

```
extern PIP_Obj inputObj;
if (PIP_getReaderNumFrames(&inputObj)) {
    . . .
}
```

The `-ml0` large model option is identical to small model except that all aggregate data is assumed to be far. This option causes all static objects to be assumed to be far objects but allows scalar types (such as `int`, `char`, `long`) to be accessed as near data. As a result, the performance degradation for many applications is quite modest.

2.6 Creating DSP/BIOS Objects Dynamically

For typical DSP applications, most objects should be created statically because they are used throughout program execution. A number of default objects are automatically defined in the configuration template. Creating objects statically provides the following benefits:

- **Reduced code size.** For a typical module, the `XXX_create()` and `XXX_delete()` functions contain 50% of the code required to implement the module. If you avoid using any calls to `TSK_create()` and `TSK_delete()`, the underlying code for these functions is not included in the application program. The same is true for other modules. By creating objects statically, you can dramatically reduce the size of your application program.
- **Improved run-time performance.** In addition to saving code space, avoiding dynamic creation of objects reduces the time your program spends performing system setup.

Creating objects statically has the following limitations:

- Static objects are created whether or not they are needed. You may want to create objects dynamically if they will be used only as a result of infrequent run-time events.
- You cannot delete static objects at run-time using the `XXX_delete` functions.

You can create many, but not all, DSP/BIOS objects by calling the function `XXX_create` where `XXX` names a specific module. Some objects can only be created statically. Each `XXX_create` function allocates memory for storing the object's internal state information, and returns a handle used to reference the newly-created object when calling other functions provided by the `XXX` module.

Most XXX_create functions accept as their last parameter a pointer to a structure of type XXX_Attrs which is used to assign attributes to the newly-created object. By convention, the object is assigned a set of default values if this parameter is NULL. These default values are contained in the constant structure XXX_ATTRS listed in the header files, enabling you to first initialize a variable of type XXX_Attrs and then selectively update its fields with application-dependent attribute values before calling XXX_create. Sample code that creates a dynamic object using the TSK_create is shown in Example 2-1.

Example 2-1 Creating and Referencing Dynamic Objects

```
#include <tsk.h>
TSK_Attrs  attrs;
TSK_Handle task;

attrs = TSK_ATTRS;
attrs.name = "reader";
attrs.priority = TSK_MINPRI;

task = TSK_create((Fxn)foo, &attrs);
```

The XXX_create function passes back a handle that is an address to the task's object. This handle is can then be passed as an argument when referencing, for example, deleting the object, as shown in Example 2-2. Objects created with XXX_create are deleted by calling the function XXX_delete. This frees the object's internal memory back to the system for later use.

Use the global constant XXX_ATTRS to copy the default values, update its fields, and pass as the argument to the XXX_create function.

Example 2-2 Deleting a Dynamic Object

```
TSK_delete (task);
```

Dynamically-created DSP/BIOS objects allow for a program to adapt at runtime.

2.7 Files Used to Create DSP/BIOS Programs

Figure 2–1 shows files used to create DSP/BIOS applications. Files you write are shown with a white background; generated files have a gray background. The word *program* represents the name of your project or program. The number 62 is replaced by 28, 55, or 64 as appropriate for your platform.

Figure 2–1 Files in a DSP/BIOS Application

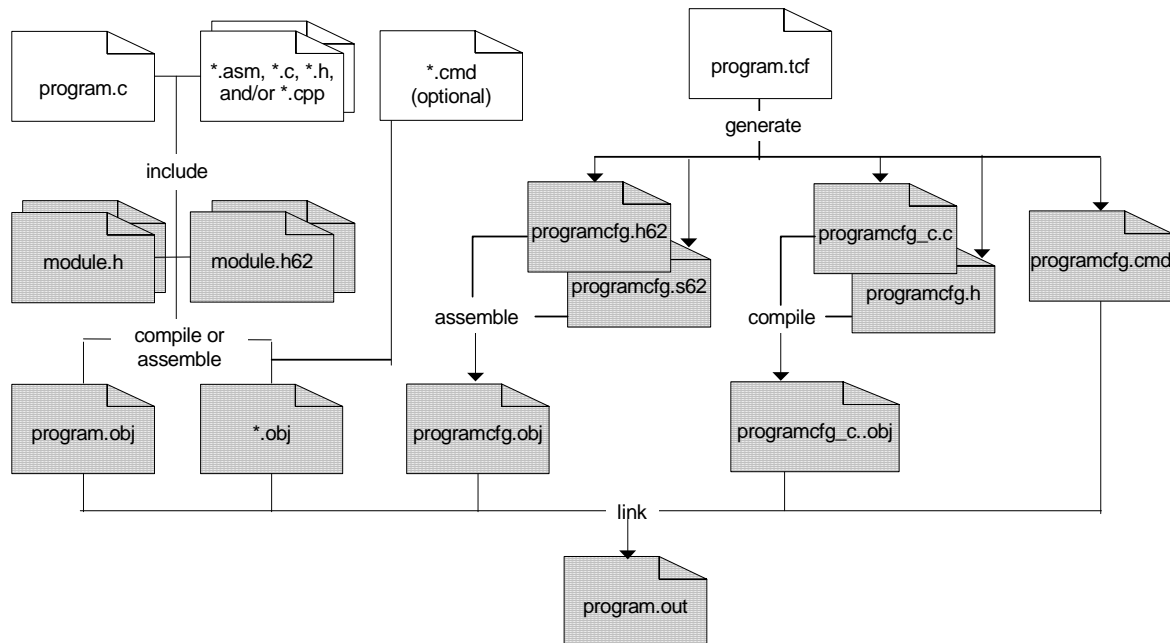

Program Files

- **program.c.** Program source file containing the main function. You can also have additional .c source files and program .h files. For user functions, see Section 2.12, *User Functions Called by DSP/BIOS*.
- **program.tcf.** The Tconf script that generates the configuration files when run. This is the source file for the configuration. This is the file you add to a Code Composer Studio project to make the configuration part of the application.
- ***.asm.** Optional assembly source file(s). One of these files can contain an assembly language function called `_main` as an alternative to using a C or C++ function called `main`.
- **module.h.** DSP/BIOS API header files for C or C++ programs. Your source files should include `std.h` and the header files for any modules the program uses.
- **module.h62.** DSP/BIOS API header files for assembly programs. Assembly source files should include the *.h64 header file for any module the assembly source uses.
- **program.obj.** Object file(s) compiled or assembled from your source file(s)
- ***.obj.** Object files for optional assembly source file(s)
- ***.cmd.** Optional linker command file(s) that contains additional sections for your program not defined by the DSP/BIOS configuration.
- **program.out.** An executable program for the target (fully compiled, assembled, and linked). You can load and run this program with Code Composer Studio commands.

Static Configuration Files

When you build a project that contains a *.tcf file in CCS, the following files are automatically created and added to the Debug folder of the project list (where "program" is the configuration file name and 62 is replaced by 28, 55, or 64 as appropriate for your platform):

- **programcfg.cmd.** Linker command file for DSP/BIOS objects. This file defines DSP/BIOS-specific link options and object names, and generic data sections for DSP programs (such as .text, .bss, .data, etc.).
- **programcfg.h.** Includes DSP/BIOS module header files and declares external variables for objects created in the configuration.
- **programcfg_c.c.** Defines DSP/BIOS related objects. (No longer defines CSL objects.)
- **programcfg.s62.** Assembly language source file for DSP/BIOS settings.
- **programcfg.h62.** Assembly language header file included by programcfg.s62.
- **program.cdb.** Stores configuration settings for use by run-time analysis tools. In previous versions, this was the configuration source file. It is now generated by running the *.tcf file. This file is used by the DSP/BIOS analysis tools.
- **programcfg.obj.** Object file created from the source file generated by the configuration.

2.8 Using Makefiles to Build Applications

You can build your DSP/BIOS executables using a Code Composer Studio project or using your own makefile. The Code Composer Studio software includes gmake.exe, the GNU make utility.

For details specific to your version of DSP/BIOS, see the SetupGuide.html and release_notes.html files in your DSP/BIOS installation.

As an alternative to building your program as a Code Composer Studio project, you can use a makefile.

In the following example, the C source code file is volume.c, additional assembly source is in load.asm, and the configuration file is volume.cdb. This makefile is for use with gmake, which is included with the Code Composer Studio software.

A typical makefile for compiling and linking a DSP/BIOS program is shown in Example 2-3.

Unlike the Code Composer Studio project, makefiles allow for multiple linker command files. If the application requires additional linker command files you can easily add them to the CMDS variable in the example makefile shown in Example 2-3. However, they must always appear after the *programcfg.cmd* linker command file generated by the Configuration Tool.

Example 2-3 Sample Makefile for a DSP/BIOS Program

```

# Makefile for creation of program named by the PROG variable
# The following naming conventions are used by this makefile:
# <prog>.asm      - C55 assembly language source file
# <prog>.obj       - C55 object file (compiled/assembled source)
# <prog>.out       - C55 executable (fully linked program)
# <prog>cfg.s55    - configuration assembly source file
#                  generated by Configuration Tool
# <prog>cfg.h55    - configuration assembly header file
#                  generated by Configuration Tool
# <prog>cfg.cmd    - configuration linker command file
#                  generated by Configuration Tool

include $(TI_DIR)/c5400/bios/include/c55rules.mak

#
# Compiler, assembler, and linker options.
# -g enable symbolic debugging
CC55OPTS = -g
AS55OPTS =
# -q quiet run
LD55OPTS = -q

# Every DSP/BIOS program must be linked with:
# $(PROG)cfg.o55 - object resulting from assembling
#                  $(PROG)cfg.s55
# $(PROG)cfg.cmd - linker command file generated by
#                  the Configuration Tool. If additional
#                  linker command files exist,
#                  $(PROG)cfg.cmd must appear first.
#
PROG      = volume
OBJS     = $(PROG)cfg.obj load.obj
LIBS     =
CMDS     = $(PROG)cfg.cmd

# Targets:
all:: $(PROG).out

$(PROG).out: $(OBJS) $(CMDS)
$(PROG)cfg.obj: $(PROG)cfg.h55
$(PROG).obj:

$(PROG)cfg.s55 $(PROG)cfg.h55 $(PROG)cfg.cmd:
    @ echo Error: $@ must be manually regenerated:
    @ echo Open and save $(PROG).cdb within the DSP/BIOS Configuration Tool.
    @ check $@

.clean clean::
    @ echo removing generated configuration files ...
    @ remove -f $(PROG)cfg.s55 $(PROG)cfg.h55 $(PROG)cfg.cmd
    @ echo removing object files and binaries ...
    @ remove -f *.obj *.out *.lst *.map

```

2.9 Using DSP/BIOS with the Run-Time Support Library

The linker command file generated by the configuration automatically includes directives to search the necessary libraries including a DSP/BIOS, RTDX, and a run-time support library. The run-time support library is created from `rts.src`, which contains the source code for the run-time support functions. These are standard ANSI functions that are not part of the C language (such as functions for memory allocation, string conversion, and string searches). A number of memory management functions that are defined within `rts.src` are also defined within the DSP/BIOS library. These are `malloc`, `free`, `memalign`, `calloc`, and `realloc`. The libraries support different implementations. For example, the DSP/BIOS versions are implemented with the MEM module and therefore make use of the DSP/BIOS API calls `MEM_alloc` and `MEM_free`. Because the DSP/BIOS library provides some of the same functionality found in the run-time support library, the DSP/BIOS linker command file includes a special version of the run-time support library called `rtsbios` that does not include the files shown in Table 2–2.

Table 2–2. Files Not Included in `rtsbios`

C55x Platform



`memory.c`
`boot.c`

C6000 Platform



`memory.c`
`sysmem.c`
`autoinit.c`
`boot.c`

In many DSP/BIOS projects, it is necessary to use the `-x` linker switch in order to force the rereading of libraries. For example, if `printf` references `malloc` and `malloc` has not already been linked in from the DSP/BIOS library, it forces the DSP/BIOS library to be searched again in order to resolve the reference to `malloc`.

Note: The run-time support library implements `printf` with breakpoints. Depending on how often your application uses `printf` and the frequency of the calls, `printf()` can interfere with RTDX, thus affecting real-time analysis tools such as the Raw Log and Statistics Data, and preventing these tools from updating. This is because the `printf` breakpoint processing has higher priority processing than RTDX. It is therefore recommended to use `LOG_printf` in place of calls to `printf` wherever possible within DSP/BIOS applications.

Note: It is recommended that you use the DSP/BIOS library version of `malloc`, `free`, `memalign`, `calloc` and `realloc` within DSP/BIOS applications. When you are not referencing these functions directly in your application but call another run-time support function which references one or more of them, add `'-u _symbol'`, (for example, `-u _malloc`) to your linker options. The `-u` linker option introduces a symbol, such as `malloc`, as an unresolved symbol into the linker's symbol table. This causes the linker to resolve the symbol from the DSP/BIOS library rather than the run-time support library. If in doubt, you can examine your map file for information on the library sources of your application.

2.10 DSP/BIOS Startup Sequence

When a DSP/BIOS application starts up, the calls or instructions in the `autoinit.c` and `boot.snn` files determine the startup sequence. Compiled versions of these files are provided with the `bios.ann` and `biosi.ann` libraries and the source code is available on the distribution disks received with your product. The DSP/BIOS startup sequence, as specified in the source code of the boot files is shown below. You should not need to alter the startup sequence.

1. **Initialize the DSP.** A DSP/BIOS program starts at the C or C++ environment entry point `c_int00`. The reset interrupt vector is set up to branch to `c_int00` after reset.



At the beginning of `c_int00` for the C55x platform, the data (user) stack pointer (XSP) and the system stack pointer (XSSP) are both set up to point to the bottom of the user and system stacks, respectively. Additionally, the XSP is aligned to an even address boundary.



For the C6000 platform, at the beginning of `c_int00`, the system stack pointer (B15) and the global page pointer (B14) are set up to point to the end of the stack section and the beginning of `.bss`, respectively. Control registers such as AMR, IER, and CSR are also initialized.

2. **Initialize the .bss from the .cinit records.** Once the stacks are set up, the initialization routine is called to initialize the variables from the `.cinit` records.
3. **Call BIOS_init to initialize the modules used by the application.** `BIOS_init` performs basic module initialization. `BIOS_init` invokes the `MOD_init` macro for each DSP/BIOS module used by the application. `BIOS_init` is generated by the configuration and is located in the `programcfg.snn` file.
 - `HWI_init` sets up the ISTRP and the interrupt selector registers, sets the NMIE bit in the IER on the C6000 platform, and clears the IFR on all platforms. See the *HWI Module Section* in the *TMS320 DSP/BIOS API Reference Guide* for your platform for more information.



Note: When configuring an interrupt, DSP/BIOS plugs in the corresponding ISR (interrupt service routine) into the appropriate location of the interrupt service table. However, DSP/BIOS does not enable the interrupt bit in IER. It is your responsibility to do this at startup or whenever appropriate during the application execution.

- **HST_init initializes the host I/O channel interface.** The specifics of this routine depend on the particular implementation used for the host to target link. For example, in the C6000 platform, if RTDX is used, `HST_init` enables the bit in IER that corresponds to the hardware interrupt reserved for RTDX.
 - **IDL_init calculates the idle loop instruction count.** If the `Auto calculate idle loop instruction count` property was set to true in the Idle Function Manager configuration, `IDL_init` calculates the idle loop instruction count at this point in the startup sequence. The idle loop instruction count is used to calibrate the CPU load displayed by the CPU Load Graph (see Section 3.6.1, *The CPU Load*, page 3-73).
4. **Process the .pinit table.** The `.pinit` table consists of pointers to initialization functions. For C++ programs, class constructors of global objects execute during `.pinit` processing.
 5. **Call your program's main routine.** After all DSP/BIOS modules have completed their initialization procedures, your main routine is called. This routine can be written in assembly, C, C++ or a combination. Because the C compiler adds an underscore prefix to function names, this can be a C or C++ function called `main` or an assembly function called `_main`.

Since neither hardware nor software interrupts are enabled yet, you can take care of initialization procedures for your own application (such as calling your own hardware initialization routines) from the main routine. Your main function can enable individual interrupt mask bits, but it should not call `HWI_enable` to globally enable interrupts.

6. **Call BIOS_start to start DSP/BIOS.** Like `BIOS_init`, `BIOS_start` is also generated by the configuration and is located in the `programcfg.snn` file. `BIOS_start` is called after the return from your main routine. `BIOS_start` is responsible for enabling the DSP/BIOS modules and invoking the `MOD_startup` macro for each DSP/BIOS module. If the TSK Manager is enabled in the configuration, the call to `BIOS_start` does not return. For example:
 - `CLK_startup` sets up the PRD register, enables the bit in the IER for the timer chosen in the CLK Manager, and finally starts the timer. (This macro is only expanded if you enable the CLK Manager in the configuration.)
 - `PIP_startup` calls the `notifyWriter` function for each created pipe object.
 - `SWI_startup` enables software interrupts.
 - `HWI_startup` enables hardware interrupts by setting the GIE bit in the CSR on the C6000 platform.
 - `TSK_startup` enables the task scheduler and launches the highest priority task that is ready to run. If the application has no tasks that are currently ready, the `TSK_idle` executes and calls `IDL_loop`. Once `TSK_startup` is called, the application begins and thus execution does not return from `TSK_startup` or from `BIOS_start`. `TSK_startup` runs only if the Task Manager is enabled in the configuration.
7. **Execute the idle loop.** You can enter the idle loop in one of two ways. If the Task Manager is enabled, the Task scheduler runs `TSK_idle` which calls `IDL_loop`. If the Task Manager is disabled, the call to `BIOS_start` returns and a call to `IDL_loop` follows. By calling `IDL_loop`, the boot routine falls into the DSP/BIOS idle loop forever. At this point, hardware and software interrupts can occur and preempt idle execution. Since the idle loop manages communication with the host, data transfer between the host and the target can now take place.

2.10.1 **Advanced Startup: C5500 Platform Only**



On the C5500 platform, the architecture allows the software to reprogram the start of the vector tables (256 bytes in overall length) by setting the registers `IVPD` and `IVPH`. By default, the hardware reset loads `0xFFFF` to both these registers and the reset vector is fetched from location `0xFF – FF00`. To move the vector tables to a different location, it is necessary to write the desired address into `IVPD` and `IVPH` **after** the hardware reset and then do a software reset, at which time the new values in `IVPD` and `IVPH` take effect.

The macro `HWI_init` loads the configured vector table address into `IVPD` and `IVPH` but must be followed by a software reset to actually bring the new `IVPD` and `IVPH` into effect.

The C5500 platform also allows for three possible stack modes (see Table 2–3). To configure the processor in any of the non-default modes, the user is required to set bits 28 and 29 to the reset vector location appropriately using the Code Composer Studio debugger tool and then to apply a software reset. For more information, please see the *TMS320C55x DSP CPU Reference Guide*.

Table 2–3. Stack Modes on the C5500 Platform

Stack Mode	Description	Reset Vector Settings
2x16 Fast Return	SP/SSP independent, RETA/CFCT used for fast return functionality	XX00 : XXXX : <24-bit vector address>
2x16 Slow Return	SP/SSP independent, RETA/CFCT not used	XX01 : XXXX : <24-bit vector address>
1x32 Slow Return (Reset default)	SP/SSP synchronized, RETA/CFCT not used	XX02 : XXXX : <24-bit vector address>

In addition, the DSP/BIOS configuration should set the Stack Mode property of the HWI Manager to match the mode used by the application. See the *TMS320C5000 DSP/BIOS API Reference Guide* for details.

2.11 Using C++ with DSP/BIOS

DSP/BIOS applications can be written in C++. An understanding of issues regarding C++ and DSP/BIOS can help to make C++ application development proceed smoothly. These issues concern memory management, name mangling, calling class methods from configured properties, and special considerations for class constructors and destructors.

2.11.1 Memory Management

The functions `new` and `delete` are the C++ operators for dynamic memory allocation and deallocation. Within DSP/BIOS applications, these operators are reentrant because they are implemented with the DSP/BIOS memory management functions `MEM_alloc` and `MEM_free`. However, memory management functions require that the calling thread obtain a lock to memory before proceeding if the requested lock is already held by another thread, blocking results. Therefore, `new` and `delete` should be used by TSK objects only.

The functions `new` and `delete` are defined by the run-time support library, not the DSP/BIOS library. Since the DSP/BIOS library is searched first, some applications can result in a linker error stating that there are undefined symbols that were first referenced within the `rtbios` (the run-time support) library. This linker error is avoided by using the `-x` linker option which forces libraries to be searched again in order to resolve undefined references. See Section 2.9, *Using DSP/BIOS with the Run-Time Support Library* for more information.

2.11.2 Name Mangling

The C++ compiler implements function overloading, operator overloading, and type-safe linking by encoding a function's signature in its link-level name. The process of encoding the signature into the linkname is referred to as name mangling. Name mangling could potentially interfere with a DSP/BIOS application since you use function names within the configuration to refer to functions declared in your

C++ source files. To prevent name mangling and thus to make your functions recognizable within the configuration, it is necessary to declare your functions in an extern C block as shown in the code fragment of Example 2-4.

Example 2-4 Declaring Functions in an Extern C Block

```
extern "C" {
Void function1();
Int function2();
}
```

This allows you to refer to the functions within the configuration. For example, if you had an SWI object which should run function1() every time that the SWI posts, you would use function1 for the function property of that SWI object.

Functions declared within the extern C block are not subject to name mangling. Since function overloading is accomplished through name mangling, function overloading has limitations for functions that are called from the configuration. Only one version of an overloaded function can appear within the extern C block. The code in Example 2-5 would result in an error.

Example 2-5 Function Overloading Limitation

```
extern "C" {
Int addNums(Int x, Int y);
Int addNums(Int x, Int y, Int z); // error, only one version
                                   // of addNums is allowed
}
```

While you can use name overloading in your DSP/BIOS C++ applications, only one version of the overloaded function can be called from the configuration.

Default parameters is a C++ feature that is not available for functions called from the configuration. C++ allows you to specify default values for formal parameters within the function declaration. However, a function called from the configuration must provide parameter values. If no values are specified, the actual parameter values are undefined.

2.11.3 Calling Class Methods from the Configuration

Often, the function that you want to reference within the configuration is the member function of a class object. It is not possible to call these member functions directly from the configuration, but it is possible to accomplish the same action through wrapper functions. By writing a wrapper function which accepts a class instance as a parameter, you can invoke the class member function from within the wrapper.

A wrapper function for a class method is shown in Example 2-6.

Example 2-6 Wrapper Function for a Class Method

```
Void wrapper (SampleClass myObject)
{
    myObject->method();
}
```

Any additional parameters that the class method requires can be passed to the wrapper function.

2.11.4 Class Constructors and Destructors

Any time that a C++ class object is instantiated, the class constructor executes. Likewise, any time that a class object is deleted, the class destructor is called. Therefore, when writing constructors and destructors, you should consider the times at which the functions are expected to execute and tailor them accordingly. It is important to consider what type of thread will be running when the class constructor or destructor is invoked.

Various guidelines apply to which DSP/BIOS API functions can be called from different DSP/BIOS threads (tasks, software interrupts, and hardware interrupts). For example, memory allocation APIs such as MEM_alloc and MEM_calloc cannot be called from within the context of a software interrupt. Thus, if a particular class is instantiated by a software interrupt, its constructor must avoid performing memory allocation. Similarly, it is important to keep in mind the time at which a class destructor is expected to run. Not only does a class destructor execute when an object is explicitly deleted, but also when a local object goes out of scope. You need to be aware of what type of thread is executing when the class destructor is called and make only those DSP/BIOS API calls that are appropriate for that thread. For further information on function callability, see the *TMS320 DSP/BIOS API Reference Guide* for your platform.

2.12 User Functions Called by DSP/BIOS

User functions called by DSP/BIOS objects (IDL, TSK, SWI, PIP, PRD, and CLK objects) need to follow specific conventions in order to ensure that registers are used properly and that values are preserved across function calls.



On the C6x and C55x platforms, all user functions called by DSP/BIOS objects need to conform to C compiler register conventions for their respective platforms. This applies to functions written both in C and assembly languages.



The compiler distinguishes between C and assembly functions by assuming that all C function names are preceded by an underscore, and assembly function names are not preceded by an underscore.

For more information on C register conventions, see the optimizing compiler user's guide for your platform.

2.13 Calling DSP/BIOS APIs from Main

The main routine in a DSP/BIOS application is for user initialization purposes such as configuring a peripheral, or enabling individual hardware interrupts. It is important to recognize that main does not fall into any of the DSP/BIOS threads types (HWI, SWI, TSK, or IDL), and that when program execution reaches main, not all of the DSP/BIOS initialization is complete. This is because DSP/BIOS initialization takes place in two phases: during BIOS_init which runs before main, and during BIOS_start which runs after your program returns from main.

Certain DSP/BIOS API calls should not be made from the main routine, because the BIOS_start initialization has not yet run. BIOS_start is responsible for enabling global interrupts, configuring and starting the timer, and enabling the schedulers so that DSP/BIOS threads can start executing. Therefore, DSP/BIOS calls that are not appropriate from main are APIs which assume hardware interrupts and the timer are enabled, or APIs that make scheduling calls that could block execution. For example, functions such as CLK_gethtime and CLK_gettime should not be called from main because the timer is not running. HWI_disable and HWI_enable should not be called because hardware interrupts are not globally

enabled. Potentially blocking calls, such as SEM_pend or MBX_pend, should not be called from main because the scheduler is not initialized. Scheduling calls such as TSK_disable, TSK_enable, SWI_disable, or SWI_enable are also not appropriate within main.

BIOS_init, which runs before main, is responsible for initialization of the MEM module. Therefore, it is okay to call dynamic memory allocation functions from main. Not only are the MEM module functions allowed (MEM_alloc, MEM_free, etc.), but APIs for dynamic creation and deletion of DSP/BIOS objects, such as TSK_create and TSK_delete, are also allowed.

While blocking calls are not permitted from main, scheduling calls that make a DSP/BIOS thread ready to run are permitted. These are calls such as SEM_post or SWI_post. If such a call is made from main, the readied thread is scheduled to run after the program returns from main and BIOS_start finishes executing.

See the *TMS320 DSP/BIOS API Reference Guide* for your platform for more information on a particular DSP/BIOS function call. The *Constraints and Calling Context* sections indicates if the API cannot be called from main.

Instrumentation

DSP/BIOS provides both explicit and implicit ways to perform real-time program analysis. These mechanisms are designed to have minimal impact on the application's real-time performance.

Topic	Page
3.1 An Overview of Real-Time Analysis	50
3.2 Real-Time Analysis Tools in CCS	51
3.3 RTOS Object Viewer (ROV)	59
3.4 Instrumentation Performance	62
3.5 Instrumentation APIs	64
3.6 Implicit DSP/BIOS Instrumentation	73
3.7 Instrumentation for Field Testing	79
3.8 Real-Time Data Exchange	79

3.1 An Overview of Real-Time Analysis

Real-time analysis is the analysis of data acquired during real-time operation of a system. The intent is to easily determine whether the system is operating within its design constraints, is meeting its performance targets, and has room for further development.

Note: RTDX is occasionally not supported for the initial releases of a new DSP device or board. On platforms where RTDX is not supported, the RTA tools in CCS are non-functional.

3.1.1 Real-Time Versus Cyclic Debugging

The traditional debugging method for sequential software is to execute the program until an error occurs. You then stop the execution, examine the program state, insert breakpoints, and reexecute the program to collect information. This kind of cyclic debugging is effective for non-real-time sequential software. However, cyclic debugging is rarely as effective in real-time systems because real-time systems are characterized by continuous operation, nondeterministic execution, and stringent timing constraints.

The DSP/BIOS instrumentation APIs and the DSP/BIOS Analysis Tools are designed to complement cyclic debugging tools to enable you to monitor real-time systems as they run. This real-time monitoring data lets you view the real-time system operation so that you can effectively debug and performance-tune the system.

3.1.2 Software Versus Hardware Instrumentation

Software monitoring consists of instrumentation code that is part of the target application. This code is executed at run time, and data about the events of interest is stored in the target system's memory. Thus, the instrumentation code uses both the computing power and memory of the target system.

The advantage of software instrumentation is that it is flexible and that no additional hardware is required. Unfortunately, because the instrumentation is part of the target application, performance and program behavior can be affected. Without using a hardware monitor, you face the problem of finding a balance between program perturbation and recording sufficient information. Limited instrumentation provides inadequate detail, but excessive instrumentation perturbs the measured system to an unacceptable degree.

DSP/BIOS provides several mechanisms that allow you to control precisely the balance between intrusion and information gathered. In addition, the DSP/BIOS instrumentation operations all have fixed, short execution times. Since the overhead time is fixed, the effects of instrumentation are known in advance and can be factored out of measurements.

3.2 Real-Time Analysis Tools in CCS

DSP/BIOS supports several Real-Time Analysis (RTA) tools provided by Code Composer Studio. These tools provides raw log information as well as graphs in real-time (while the target is running). The subsections that follow briefly introduce the RTA tools in CCS. In order to use RTA tools, your application must be configured to include support for RTA.

To open a tool while debugging an application, choose **Tools > RTOS Analyzer > RTA (Legacy)** from the menu bar in CCS. This menu lists the available graphs and tables provided for real-time analysis.

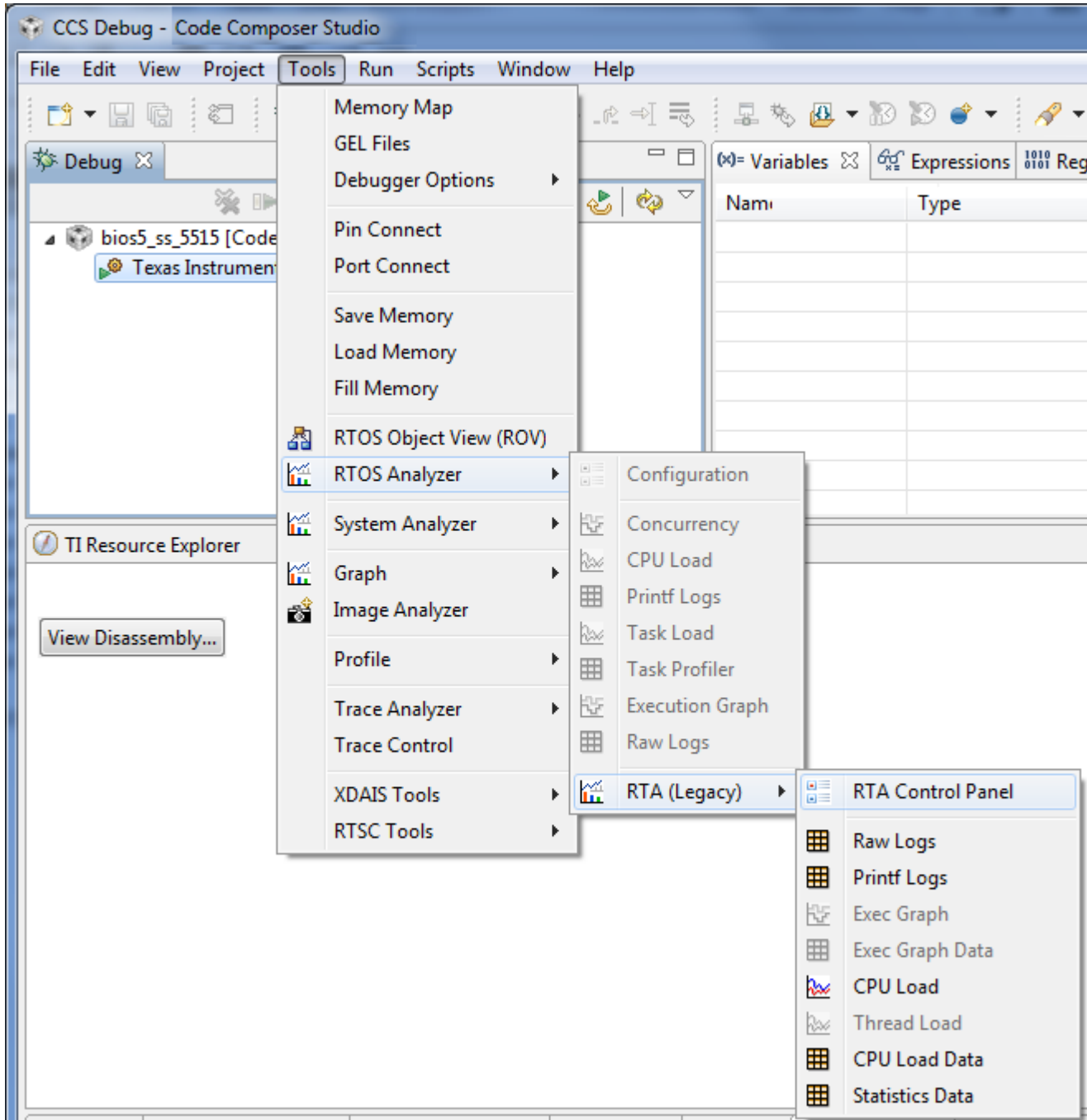

Information about DSP/BIOS modules is available in the following real-time analysis tools:

Module	Tools That Show Information About this Module
BUF	BUF in the RTOS Object View shows usage information.
CLK	<p>Execution Graph shows clock ticks.</p> <p>KNL in the RTOS Object View shows the current value of the clock used for timer functions and task sleep alarms.</p> <p>RTA Control Panel disables CLK logging.</p>
DEV	DEV in the RTOS Object View shows status information.
GBL	KNL in the RTOS Object View shows the type of processor.
HWI	<p>CPU Load Graph shows load consumed by all threads other than IDL threads.</p> <p>Execution Graph shows HWI execution in the Other Threads row.</p> <p>RTA Control Panel disables HWI statistics.</p> <p>Statistics View shows statistics gathered for HWI objects.</p>
IDL	Execution Graph shows IDL function execution in the Other Threads row.
LCK	No information provided unless program explicitly instruments these objects.
LOG	<p>Execution Graph provides a graphical view of system log data.</p> <p>RTA Control Panel disables implicit logging for SWI, PRD, CLK, and TSK modules.</p> <p>Property page for the RTA Control Panel sets the polling rate for LOG data.</p>
MBX	MBX in the RTOS Object View shows status information.
MEM	<p>KNL in the RTOS Object View shows the system stack location, size, and peak usage.</p> <p>TSK in the RTOS Object View shows stack use by tasks.</p> <p>MEM in the RTOS Object View shows usage information.</p>
MSGQ	MSGQ in the RTOS Object View shows usage information.
PIP	<p>RTA Control Panel disables PIP statistics.</p> <p>Statistics View shows statistics gathered for PIP objects.</p>
PRD	<p>Execution Graph shows PRD ticks.</p> <p>CPU Load Graph shows load consumed by all threads other than IDL threads.</p> <p>RTA Control Panel disables PRD logging and statistics.</p> <p>Statistics View shows statistics gathered for PRD objects.</p>
QUE	No information provided unless program explicitly instruments these objects.
RTDX	See the RTDX help.

Module	Tools That Show Information About this Module
SEM	<p>Execution Graph shows SEM posts.</p> <p>SEM in the RTOS Object View shows status information.</p>
SIO	<p>SIO in the RTOS Object View shows status information.</p>
STS	<p>CPU Load Graph provides a graphical view of data collected by built-in STS objects.</p> <p>RTA Control Panel disables implicit statistics accumulation for SWI, PRD, PIP, HWI, and TSK modules.</p> <p>Property page for the RTA Control Panel sets the polling rate for statistics data.</p> <p>Statistics View shows statistics gathered by STS objects.</p>
SWI	<p>CPU Load Graph shows load consumed by all threads other than IDL threads.</p> <p>Execution Graph shows SWI execution.</p> <p>SWI in the RTOS Object View shows status information.</p> <p>RTA Control Panel disables SWI logging and statistics.</p> <p>Statistics View shows statistics gathered for SWI objects.</p>
TRC	<p>RTA Control Panel disables and enables global tracing and trace bits for various modules.</p> <p>Property page for the RTA Control Panel sets the polling rate for TRC data set programmatically.</p>
TSK	<p>CPU Load Graph shows load consumed by all threads other than IDL threads.</p> <p>Execution Graph shows task execution.</p> <p>KNL in the RTOS Object View lists tasks blocked by timers.</p> <p>MBX in the RTOS Object View lists tasks blocked by pending or posting on a mailbox.</p> <p>SEM in the RTOS Object View lists tasks blocked by pending on a semaphore.</p> <p>TSK in the RTOS Object View shows status information.</p> <p>RTA Control Panel disables TSK logging and statistics.</p> <p>Statistics View shows statistics gathered for TSK objects.</p>

3.2.1 RTA Control Panel

The RTA Control Panel lets you see and set what type of logging is performed at run-time. You can open this panel by choosing **Tools > RTOS Analyzer > RTA (Legacy) > RTA Control Panel** from the CCS menu bar.

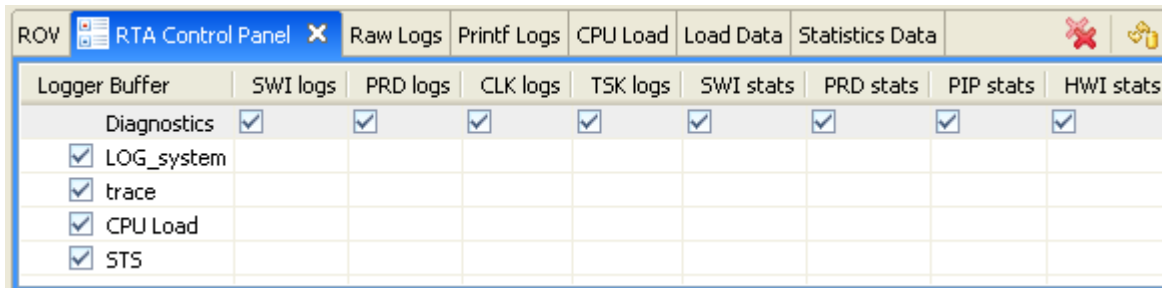







Important: In general, you should avoid modifying log settings unless you are familiar with the effects that change will have.

The checkboxes in the Diagnostics row correspond to the TRC module constants shown in Table 3–2. The Logger Buffer row also lists all LOG instances in the application, along with CPU Load and STS. Disabling a LOG instance, affects messages in the Raw Logs and Printf Logs tools. Disabling CPU Load logging disables updates to the CPU Load and Load Data tools. Disabling STS logging disables updates to the Statistics Data tool.

You can enable and disable various types of logging and diagnostics at run-time. To change the setting for a field, click in the field so you can see the drop-down arrow. Click the drop-down arrow and select Enable Logging or Disable Logging (or for the Diagnostics row, select RUNTIME_ON or RUNTIME_OFF). Then click on or tab to another field to apply the change.

This panel contains the following toolbar icons:

-  Close all RTA tools, including this one.
-  Refresh view of settings by getting the current runtime settings from the target application.
-  Automatically fit the columns to their current contents.
-  Expand all nodes in the Logger Buffer column.
-  Collapse all nodes in the Logger Buffer column.
-  Set duration (in minutes) for RTA data streaming from the target. The default is to stream as long as the target application is running.
-  Toggle data streaming from the target on or off. The default is on.

3.2.2 Raw Logs

By default, the Raw Logs tool displays complete unformatted log data. The default columns displayed are: time, seqID, arg1...arg4, and formattedMsg. You can open this tool by choosing **Tools > RTOS Analyzer > RTA (Legacy) > Raw Logs** from the CCS menu bar.

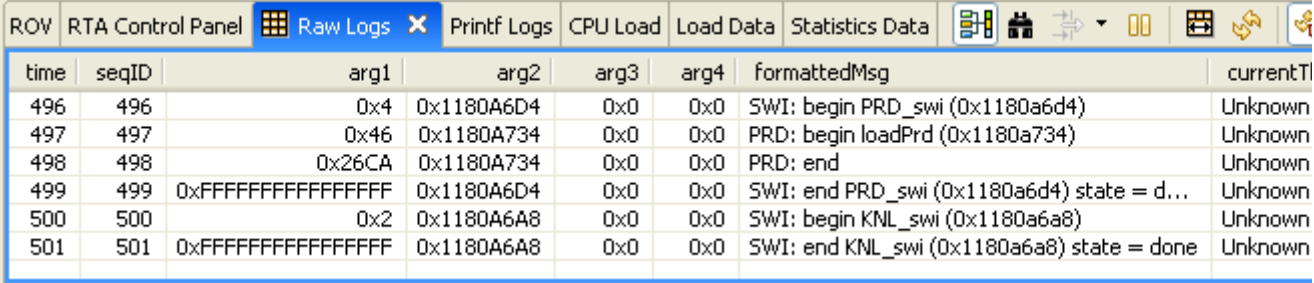







time	seqID	arg1	arg2	arg3	arg4	formattedMsg	currentTI
496	496	0x4	0x1180A6D4	0x0	0x0	SWI: begin PRD_swi (0x1180a6d4)	Unknown
497	497	0x46	0x1180A734	0x0	0x0	PRD: begin loadPrd (0x1180a734)	Unknown
498	498	0x26CA	0x1180A734	0x0	0x0	PRD: end	Unknown
499	499	0xFFFFFFFFFFFFFFFF	0x1180A6D4	0x0	0x0	SWI: end PRD_swi (0x1180a6d4) state = d...	Unknown
500	500	0x2	0x1180A6A8	0x0	0x0	SWI: begin KNL_swi (0x1180a6a8)	Unknown
501	501	0xFFFFFFFFFFFFFFFF	0x1180A6A8	0x0	0x0	SWI: end KNL_swi (0x1180a6a8) state = done	Unknown

This table displays all the log records that have been sent from the target. This contains all the records used by the RTA tools to populate their graphs and tables. In addition, the following types of logs are also shown:

- Any implicit LOG messages from other modules
- Any user-defined LOGs or LOG_printf() calls

This tool contains the following toolbar icons:

-  Toggle view with group setting on and off. (Shift+G)
-  Open the Find In dialog for searching this log.
-  Open the Set Filter Expression dialog for filtering the log records to match a pattern.
-  Pause data updates from the target. This is useful when you are using the Find or Filter dialogs. (Shift+F5)
-  Automatically fit the columns to their current contents.
-  Refresh data from the target. This is useful if you have stopped data streaming or paused updates.
-  Toggle data streaming from the target on or off. The default is on.

Grouping in the RTA views refers to synchronizing the views so that moving around in one view causes similar movement to happen automatically in another. For example, if you group the CPU load graph with Raw Logs, then if you click on the CPU Load graph, the Raw Log displays the closest record to where you clicked in the graph.

You can right-click on this tool to choose from a menu of options. In addition to some of the toolbar commands, you can use the following additional commands from the right-click menu:

- **Column Settings.** This command opens a dialog that lets you hide or display various columns. You can also change the alignment, font, and display format of a column (for example, decimal, binary, or hex).
- **Copy.** This command copies the selected text to the clipboard.
- **Data > Export Selected.** This command lets you select a .csv (comma-separated value) file to contain the selected data.

- **Data > Export All.** This command lets you select a .csv (comma-separated value) file to contain all the data currently displayed in the log.
- **Groups.** This command lets you define groups to contain various types of log messages.

3.2.3 Printf Logs

The Printf Log is a convenient way to view all the user-generated LOG_printf() messages. By default, the Printf Log tool displays the time, seqID, and formattedMsg. You can open this tool by choosing **Tools > RTOS Analyzer > RTA (Legacy) > Printf Logs** from the CCS menu bar.

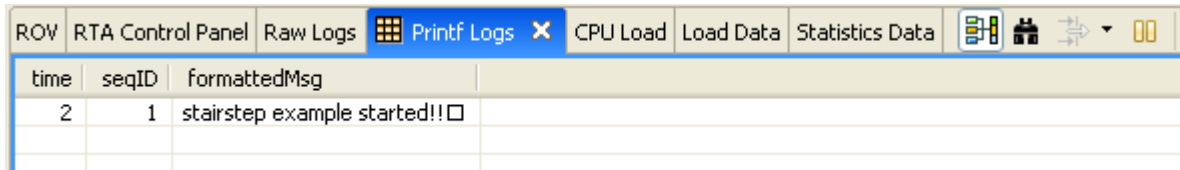

time	seqID	formattedMsg
2	1	stairstep example started!!

The toolbar icons and right-click menu for the Printf Logs tool are the same as for the Raw Logs tool (Section 3.2.2).

3.2.4 CPU Load

The CPU Load tool shows the percentage of time the application is not in the idle loop. You can open this tool by choosing **Tools > RTOS Analyzer > RTA (Legacy) > CPU Load** from the CCS menu bar.

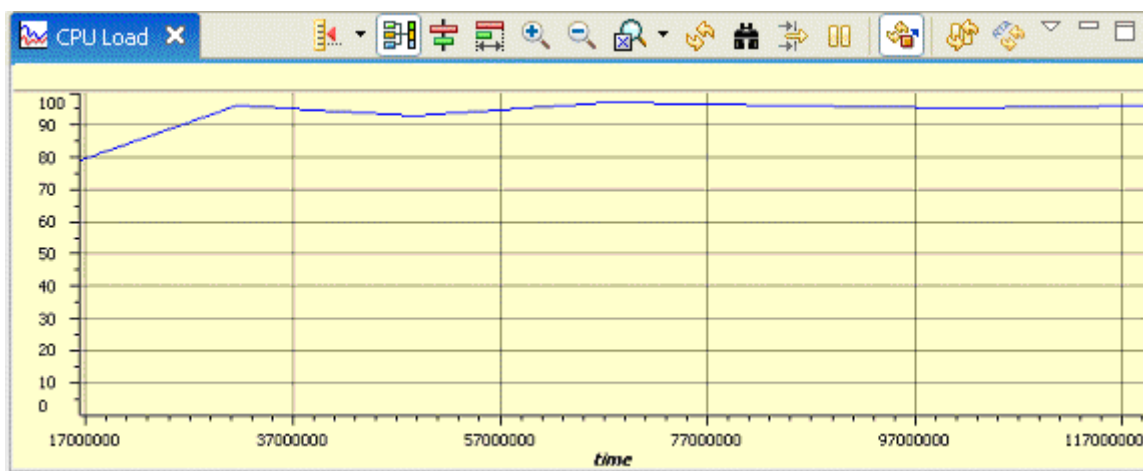









See Section 3.6.1 for information about how CPU load is calculated.

This tool contains the following toolbar icons:

 Select a measuring mode for time marking. The mode choices are Freeform or Snap to Data. The axis choices are X-Axis, Y-Axis, or Both. When you click on the graph, a marker of the type you have selected is placed. When you drag your mouse around the graph, the time is shown in red.

 Toggle view with group setting on and off. (Shift+G)

 If you have enabled the view with group setting, you can choose to align a group by centering.

-  If you have enabled the view with group setting, you can choose to align a group using a horizontal range.
-  Click this icon to zoom in on the graph by spreading out the x-axis.
-  Click this icon to zoom out.
-  Choose to reset the zoom level to the default or choose a specific zoom level.
-  Refresh data from the target. This is useful if you have stopped data streaming or paused updates.
-  Open the Find In dialog for searching this graph.
-  Open the Set Filter Expression dialog for filtering the log records to match a pattern.
-  Pause data updates from the target. This is useful when you are using the Find or Filter dialogs. (Shift+F5)
-  Toggle data streaming from the target on or off. The default is on.

You can right-click on this tool to choose from a menu of options. In addition to some of the toolbar commands, you can use the following additional commands from the right-click menu:

- **Legend.** Toggle this command to hide the graph legend.
- **Horizontal Axis.** Toggle this command to hide the x-axis time markings.
- **Vertical Axis.** Toggle this command to hide the y-axis thread labels.
- **Show Grid Lines.** Toggle on or off the x-axis and y-axis grid lines you want to see.
- **Display As.** Choose the marker you want to use to display the data. The default is a connected line, but you can choose from various marker styles and sizes.
- **Auto Scale.** Scales the load data to fit the range in use. For example, if the range is between 70% and 90%, it zooms in on that range to make changes more visible. When auto scale is turned on, the scale may change as new data arrives.
- **Reset Auto Scale.** Resets the scale to better display the current data.
- **Data > Export All.** This command lets you select a .csv (comma-separated value) file to contain all the data currently displayed in the log.
- **Groups.** This command lets you define groups to contain various types of log messages.
- **Insert Measurement Mark.** Inserts a marker at the location where you right clicked.
- **Remove Measurement Mark.** Lets you select a marker to remove.
- **Remove All Measurement Marks.** Removes all markers you have placed.
- **Display Properties.** Opens a dialog that lets you change the colors, scales, display formats, and labels on the graph.

3.2.5 Load Data

The Load Data tool is a convenient way to view all the CPU load-related logs. By default, the Load Data tool displays the time, taskHandle, task, cpuTime, total, and load for each load-related message. You can open this tool by choosing **Tools > RTOS Analyzer > RTA (Legacy) > Load Data** from the CCS menu bar.

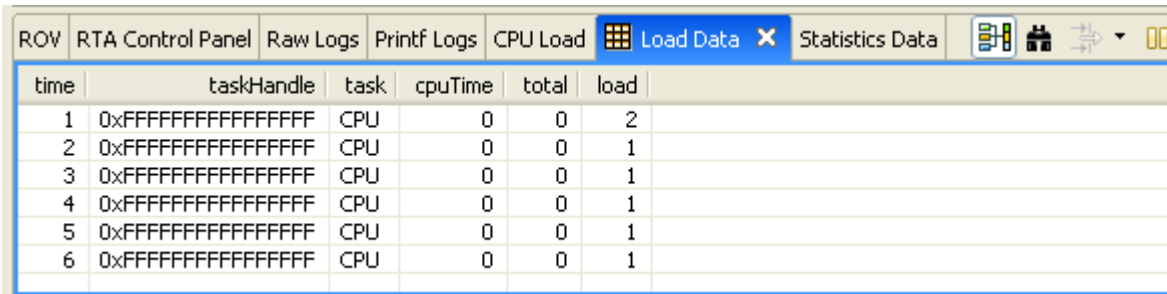

time	taskHandle	task	cpuTime	total	load
1	0xFFFFFFFFFFFFFFFF	CPU	0	0	2
2	0xFFFFFFFFFFFFFFFF	CPU	0	0	1
3	0xFFFFFFFFFFFFFFFF	CPU	0	0	1
4	0xFFFFFFFFFFFFFFFF	CPU	0	0	1
5	0xFFFFFFFFFFFFFFFF	CPU	0	0	1
6	0xFFFFFFFFFFFFFFFF	CPU	0	0	1

The messages shown in this tool are the raw data used to plot the CPU Load graph.

The toolbar icons and right-click menu for the Load Data tool are the same as for the Raw Logs tool (Section 3.2.2).

3.2.6 Statistics Data

The Statistics Data tool lets you view statistics about thread execution. You can open this tool by choosing **Tools > RTOS Analyzer > RTA (Legacy) > Statistics Data** from the CCS menu bar.

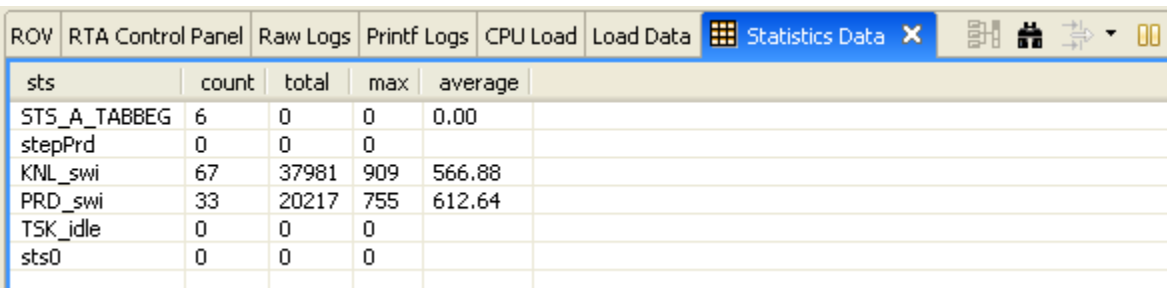

sts	count	total	max	average
STS_A_TABBEG	6	0	0	0.00
stepPrd	0	0	0	
KNL_swi	67	37981	909	566.88
PRD_swi	33	20217	755	612.64
TSK_idle	0	0	0	
sts0	0	0	0	

By default, the Statistics Data tool displays the STS object name, count, total, max, and average for each STS object.

The toolbar icons and right-click menu for the Load Data tool are the same as for the Raw Logs tool (Section 3.2.2).

3.3 RTOS Object Viewer (ROV)

If you are using DSP/BIOS with CCS, the RTOS Object Viewer (ROV) is a debugging tool you can use with applications that make use of DSP/BIOS. This viewer provides state information about all the modules in the application. (CCSv3 called this tool the Kernel Object View or KOV.)

ROV is a stop-mode debugging tool, which means it can receive data about an application only when the target is halted, not when it is running. ROV provides data at stop points even if you have disabled RTDX in your application. In contrast, the Real-Time Analysis (RTA) tools require RTDX.

To open ROV, follow these steps:

1. Load your application for debugging. If you are using a multi-core device, select the device you want to debug before opening ROV.
2. Choose **Tools > RTOS Object View (ROV)** from the CCS menus. This opens the ROV area at the bottom of the CCS window. (You can open ROV at any time while you have an application loaded.)
3. Run the application to a breakpoint at which you want to view information.
4. In the left pane of the ROV, select a module from the expandable tree.
5. In the right pane of the ROV, you may need to expand a hierarchy of objects or select a tab to view the data you want. (The tabs vary depending on the module you select.)

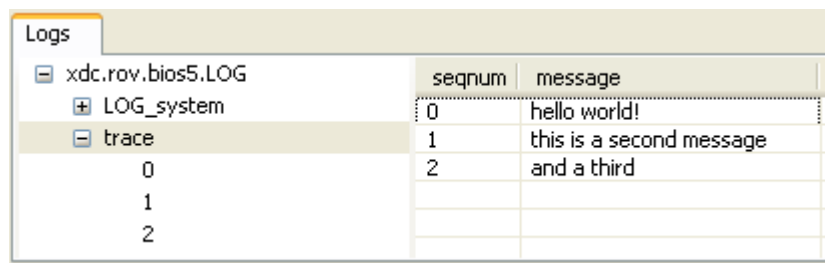

Logs		seqnum	message
[-] xdc.rov.bios5.LOG			
[+] LOG_system		0	hello world!
[-] trace		1	this is a second message
0		2	and a third
1			
2			

When you reload or rerun the application, ROV clears all of its cached data.

When the application halts at a breakpoint, ROV refreshes the currently displayed information. If any data has changed since the last time ROV requested that particular data, ROV displays that data in **red text**. Keep in mind, however, that ROV only retrieves data when it is requested. If ROV did not get an item at the last breakpoint, it has nothing to compare it to at the current breakpoint. In short, if a field is not red, this does not necessarily mean that the data did not change.

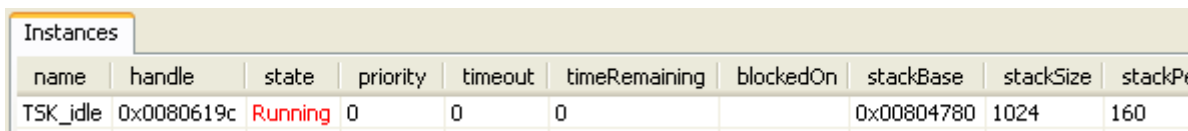

Instances									
name	handle	state	priority	timeout	timeRemaining	blockedOn	stackBase	stackSize	stackP
TSK_idle	0x0080619c	Running	0	0	0		0x00804780	1024	160

While the target is running, you may continue to explore ROV. Any data that was retrieved at the last breakpoint is shown with a gray background. If data was not retrieved, you see a "Target running..." message that indicates that ROV cannot retrieve new data while the target is running.

ROV highlights errors by making the background red. Hover your mouse over a field with a red background to see the error message. ROV can detect the following types of errors:

- **Validation errors.** Modules can provide validation information for ROV. For example, a particular structure field can have a maximum value of 32. If the value on the target is 33, the module can report this as a problem.

- **Memory.** ROV may report bad memory accesses or other detectable problems.
- **ROV errors.** ROV reports standard exceptions if a corrupted data from the target causes ROV-related code in a module to behave incorrectly.

3.3.1 Tasks

The properties listed for tasks (TSK) are as follows:

- **Name.** The name of the task. The name is taken from the label for statically-configured tasks and is generated for dynamically-created tasks. The label matches the name in the configuration.
- **Handle.** The address of the task object header on the target.
- **State.** The current state of the task: Ready, Running, Blocked, or Terminated.
- **Priority.** The task's priority as set in the configuration or as set by the API. Valid priorities are 0 through 15.
- **Timeout.** If blocked with a timeout, the clock value at which the task alarm will occur.
- **Time Remaining.** Time remaining until the timeout expires.
- **Blocked On.** If blocked on a semaphore or mailbox, the name of the SEM or MBX object the task is blocked on.
- **Stack Base.** Beginning address of the task stack.
- **Stack Size.** Size of the task stack.
- **Stack Peak.** Peak amount of the task stack used at any one time.
- **Start of SysStack.** Beginning address of the system stack. (C55x only)
- **Size of SysStack.** Size of the system stack. (C55x only)
- **SysStack Peak.** Peak amount of the system stack used at any one time. (C55x only)

3.3.2 Software Interrupts

The properties listed for software interrupts (SWI) are as follows.

- **Name.** The name of the software interrupt object. The name is taken from the label for statically-configured software interrupts and is generated for dynamically-created software interrupts. The label matches the name in the configuration.
- **Handle.** The address of the software interrupt object header on the target.
- **State.** The software interrupt's current state. Valid states are Inactive, Ready, and Running.
- **Priority.** The software interrupt's priority as set in the configuration or during creation. Valid priorities are 0 through 15.
- **Mailbox Value.** The software interrupt's current mailbox value.
- **Function.** The name of the function called by this software interrupt.
- **arg0, arg1.** The arguments sent to the function by this software interrupt. These are set in the configuration or during creation.
- **Function Address.** The address of the function on the target.

3.3.3 Mailboxes

The properties listed for mailboxes (MBX) are as follows:

- **Name.** The name of the mailbox. The name is taken from the label for statically-configured mailboxes and is generated for dynamically-created mailboxes. The label matches the name in the configuration.
- **Handle.** The address of the mailbox object header on the target.
- **# Tasks Pending.** The number of tasks currently blocked waiting to read a message from this mailbox.
- **Tasks Pending.** A pull-down list of the names of tasks currently blocked waiting to read a message from this mailbox.
- **# Tasks Blocked Posting.** The number of tasks currently blocked waiting to write a message to this mailbox.
- **Tasks Posting.** A pull-down list of the names of tasks currently blocked waiting to write a message to this mailbox.
- **# Msgs.** The current number of messages that the mailbox contains.
- **Max Msgs.** The maximum number of messages the mailbox can hold. This matches the value set during configuration or creation.
- **Msg Size.** The size of each message in the processor's minimum addressable data units (MADUs). This matches the values set during configuration or creation.
- **Mem Segment.** The name of the memory segment in which the mailbox is located. You can right-click on a segment name and choose the Go To command to display that MEM segment in the ROV tool.

3.3.4 Semaphores

The properties listed for semaphores (SEM) are as follows.

- **Name.** The name of the semaphore. The name is taken from the label for statically-configured semaphores and is generated for dynamically-created semaphores. The label matches the name in the configuration.
- **Handle.** The address of the semaphore object header on the target.
- **Count.** The current semaphore count. This is the number of pends that can occur before blocking.
- **# Tasks Pending.** The number of tasks currently pending on the semaphore.
- **Tasks Pending.** A pull-down list of the names of tasks pending on the semaphore.

3.3.5 Memory

DSP/BIOS allows you to configure memory segment objects. A segment may or may not contain a heap from which memory may be allocated dynamically. ROV focuses on displaying the properties of dynamic memory heaps within memory segment objects. The properties listed for memory segments and heaps (MEM) are as follows.

- **Name.** The name of a memory segment object as configured.
- **Largest Free Block.** The maximum amount of contiguous memory that is available for allocation in the heap within this memory segment.

- **Free Mem.** The total amount of memory (in MADUs) that is not in use by the application and is free to be allocated from the heap.
- **Used Mem.** The amount of memory (in MADUs) that has been allocated from the heap. If this value is equal to the total size, a warning is indicated by coloring this field red.
- **Total Size.** The total number of minimum addressable units (MADUs) in the heap.
- **Start Address.** The starting location of the heap.
- **End Address.** The ending location of the heap.
- **Mem Segment.** The number of the memory segment in which the heap is located.

3.3.6 *Buffer Pools*

The properties listed for buffer pools (BUF) are as follows.

- **Name.** The name of the buffer pool object. The name is taken from the label for statically-configured pools and is generated for dynamically-created pools. The label matches the name in the configuration.
- **Segment ID.** The name of the memory segment in which the buffer pool exists.
- **Size of Buffer.** The size (in MADUs) of each memory buffer inside the buffer pool.
- **# Buffers in Pool.** The number of buffers in the buffer pool.
- **# Free Buffers.** The current number of available buffers in the buffer pool.
- **Pool Start Address.** The address on the target where the buffer pool starts.
- **Max Buffers Used.** The peak number of buffers that have been used in the pool.

3.4 Instrumentation Performance

When all implicit DSP/BIOS instrumentation is enabled, the CPU load increases less than one percent in a typical application. Several techniques have been used to minimize the impact of instrumentation on application performance:

- Instrumentation communication between the target and the host is performed in the background (IDL) thread, which has the lowest priority, so communicating instrumentation data does not affect the real-time behavior of the application.
- From the host, you can control the rate at which the host polls the target. You can stop all host interaction with the target if you want to eliminate all unnecessary external interaction with the target.
- The target does not store implicit statistics information unless tracing is enabled. You also have the ability to enable or disable the explicit instrumentation of the application by using the TRC module and one of the reserved trace masks (TRC_USER0 and TRC_USER1).
- Log and statistics data are always formatted on the host. The average value for an STS object and the CPU load are computed on the host. Computations needed for RTA tool displays are performed on the host.

- LOG, STS, and TRC module operations are very fast and execute in constant time, as shown in the following list:
 - LOG_printf and LOG_event: approximately 25 instructions
 - STS_add: approximately 10 instructions
 - STS_delta: approximately 15 instructions
 - TRC_enable and TRC_disable: approximately four instructions
 - LOG_printf and LOG_event: approximately 32 instructions
 - STS_add: approximately 18 instructions
 - STS_delta: approximately 21 instructions
 - TRC_enable and TRC_disable: approximately six instructions
- Each STS object uses only eight or four words of data memory, for the C5000 platform or the C6000 platform, respectively. This means that the host always transfers the same number of words to upload data from a statistics object.
- Statistics are accumulated in 32-bit variables on the target and in 64-bit variables on the host. When the host polls the target for real-time statistics, it resets the variables on the target. This minimizes space requirements on the target while allowing you to keep statistics for long test runs.
- You can specify the buffer size for LOG objects. The buffer size affects the program's data size and the time required to upload log data.
- For performance reasons, implicit hardware interrupt monitoring is disabled by default. When disabled, there is no effect on performance. When enabled, updating the data in statistics objects consumes between 20 and 30 instructions per interrupt for each interrupt monitored.

3.4.1 Instrumented Versus Non-instrumented Kernel

It is possible to disable support for kernel instrumentation by changing the global properties of the application. The GBL module has a property called Enable Real Time Analysis. By setting this property to false, you can achieve optimal code size and execution speed. This is accomplished by linking with a DSP/BIOS library that does not support the implicit instrumentation. However, this also has the effect of removing support for DSP/BIOS Analysis Tools and explicit instrumentation such as the LOG, TRC, and STS module APIs.



The Table 3–1 presents examples of code size increases when working with the instrumented versus non-instrumented kernel. These figures provide a general idea of the amount of code increase that can be expected when working with the instrumented kernel.

Table 3–1 uses as samples two projects that utilize many of the DSP/BIOS features. By including DSP/BIOS modules, the applications incorporate the instrumentation code. Therefore the following numbers are representative of the amount of code size incurred by the instrumentation, and are not affected by the size or variations among users' applications. The first application, Slice, contains the TSK, SEM, and PRD modules, while the second, Echo, uses the PRD and SWI modules. Neither application is specifically designed for minimizing code size.



For information on DSP/BIOS kernel performance benchmarks, including a comparison of the instrumented versus non-instrumented kernels' performances, see Application Report SPRA662, *DSP/BIOS Timing Benchmarks on the TMS320C6000 DSP*.

Table 3–1. Examples of Code-size Increases Due to an Instrumented Kernel

a) Example: Slice

	C55x Platform	C6000 Platform
Description (all sizes in MADUs)		
Size with non-instrumented kernel	32,000	78,900
Size with instrumented kernel	33,800	86,600
Size increase with instrumented kernel	1,800	7,700

b) Example: Echo

	C55x Platform	C6000 Platform
Description (all sizes in MADUs)		
Size with non-instrumented kernel	41,200	68,800
Size with instrumented kernel	42,800	76,200
Size increase with instrumented kernel	1,600	7,400

3.5 Instrumentation APIs

Effective instrumentation requires both operations that gather data and operations that control the gathering of data in response to program events. DSP/BIOS provides the following three API modules for data gathering:

- **LOG (Event Log Manager).** Log objects capture information about events in real time. System events are captured in the system log. You can configure additional logs. Your program can add messages to any log.
- **STS (Statistics Object Manager).** Statistics objects capture count, maximum, and total values for any variables in real time. Statistics about SWI (software interrupt), PRD (period), HWI (hardware interrupt), PIP (pipe), and TSK (task) objects can be captured automatically. In addition, your program can create statistics objects to capture other statistics.
- **HST (Host Channel Manager).** The host channel objects described in Chapter 7, *Input/Output Overview and Pipes*, allow a program to send raw data streams to the host for analysis.

LOG and STS provide an efficient way to capture subsets of a real-time sequence of events that occur at high frequencies or a statistical summary of data values that vary rapidly. The rate at which these events occur or values change may be so high that it is either not possible to transfer the entire sequence to the host (due to bandwidth limitations) or the overhead of transferring this sequence to the host would interfere with program operation. DSP/BIOS provides the TRC (Trace Manager) module for controlling the data gathering mechanisms provided by the other modules. The TRC module controls which events and statistics are captured either in real time by the target program or interactively through the DSP/BIOS Analysis Tools.

Controlling data gathering is important because it allows you to limit the effects of instrumentation on program behavior, ensure that LOG and STS objects contain the necessary information, and start or stop recording of events and data values at run time.

3.5.1 *Explicit versus Implicit Instrumentation*

The instrumentation API operations are designed to be called explicitly by the application. The LOG module operations allow you to explicitly write messages to any log. The STS module operations allow you to store statistics about data variables or system performance. The TRC module allows you to enable or disable log and statistics tracing in response to a program event.

The LOG and STS APIs are also used internally by DSP/BIOS to collect information about program execution. These internal calls in DSP/BIOS routines provide implicit instrumentation support. As a result, even applications that do not contain any explicit calls to the DSP/BIOS instrumentation APIs can be monitored and analyzed using the DSP/BIOS Analysis Tools. For example, the execution of a software interrupt is recorded in a LOG object called LOG_system.

In addition, worst-case ready-to-completion times for software interrupts and overall CPU load are accumulated in STS objects. See Section 3.5.4.2, *Control of Implicit Instrumentation*, page 3-71, for more information about what implicit instrumentation can be collected.

3.5.2 *Event Log Manager (LOG Module)*

This module manages LOG objects, which capture events in real time while the target program executes.

User-defined logs contain any information your program stores in them using the LOG_event and LOG_printf operations. You can view messages in these logs in real time with the CCS Printf Logs RTA tool. To access this tool, choose **Tools > RTOS Analyzer > RTA (Legacy) > Printf Logs** from the CCS menu bar.

A log can be either fixed or circular. This distinction is important in applications that enable and disable logging programmatically (using the TRC module operations as described in section 3.4.4, *Trace Manager (TRC Module)*, page 3-13).

- **Fixed.** The log stores the first messages it receives and stops accepting messages when its message buffer is full. As a result, a fixed log stores the first events that occur since the log was enabled.
- **Circular.** The log automatically overwrites earlier messages when its buffer is full. As a result, a circular log stores the last events that occur.

You configure LOG objects statically and assign properties such as the length and location of the message buffer.

You specify the length of each message buffer in words. Individual messages use four words of storage in the log's buffer. The first word holds a sequence number. The remaining three words of the message structure hold event-dependent codes and data values supplied as parameters to operations such as LOG_event, which appends new events to a LOG object.

As shown in Figure 3–1, LOG buffers are read from the target and stored in a much larger buffer on the host. Records are marked empty as they are copied up to the host.

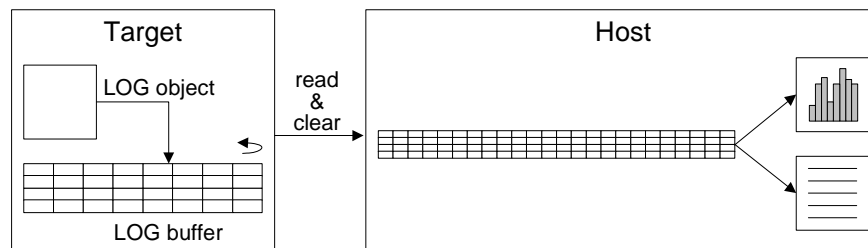
Figure 3–1 LOG Buffer Sequence

LOG_printf uses the fourth word of the message structure for the offset or address of the format string (for example, %d, %d). The host uses this format string and the two remaining words to format the data for display. This minimizes both the time and code space used on the target since the actual printf operation (and the code to perform the operation) are handled on the host.

LOG_event and LOG_printf both operate on logs with interrupts disabled. This allows hardware interrupts and other threads of different priorities to write to the same log without having to worry about synchronization.

Log messages shown in a message log window are numbered to indicate the order in which the events occurred. These numbers are an increasing sequence starting at 0. If your log never fills up, you can use a smaller log size. If a circular log is not long enough or you do not poll the log often enough, you may miss some log entries that are overwritten before they are polled. In this case, you see gaps in the log message numbers. You may want to add an additional sequence number to the log messages to make it clear whether log entries are being missed.

The DSP/BIOS online help describes LOG objects and their parameters. See *LOG Module* in the *TMS320 DSP/BIOS API Reference Guide* for your platform for information on the LOG module API calls.

3.5.3 Statistics Object Manager (STS Module)

This module manages statistics objects, which store key statistics while a program runs.

You configure individual statistics objects statically. Each STS object accumulates the following statistical information about an arbitrary 32-bit wide data series:

- **Count.** The number of values on the target in an application-supplied data series
- **Total.** The arithmetic sum of the individual data values on the target in this series
- **Maximum.** The largest value already encountered on the target in this series
- **Average.** Using the count and total, the Statistics Data tool calculates the average on the host

Calling the STS_add operation updates the statistics object of the data series being studied. For example, you might study the pitch and gain in a software interrupt analysis algorithm or the expected and actual error in a closed-loop control algorithm.

DSP/BIOS statistics objects are also useful for tracking absolute CPU use of various routines during execution. By bracketing appropriate sections of the program with the STS_set and STS_delta operations, you can gather real-time performance statistics about different portions of the application.

You can view these statistics in real time with the Statistics Data tool. To access the Statistics Data tool, choose **Tools > RTOS Analyzer > RTA (Legacy) > Statistics Data** from the CCS menu bar.

Although statistics are accumulated in 32-bit variables on the target, they are accumulated in 64-bit variables on the host. When the host polls the target for real-time statistics, it resets the variables on the target. This minimizes space requirements on the target while allowing you to keep statistics for long test runs. The Statistics Data tool can optionally filter the data arithmetically before displaying it as shown in Figure 3–2.

Figure 3–2 Target/Host Variable Accumulation

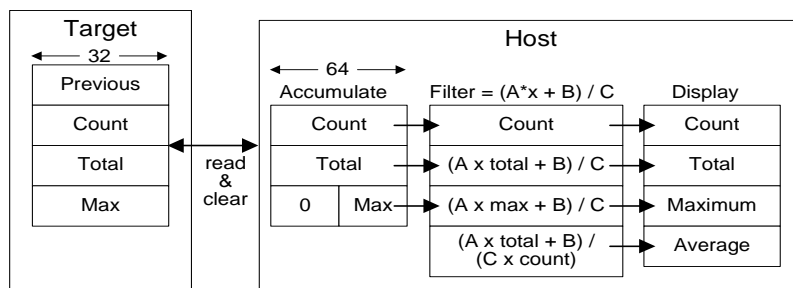

By clearing the values on the target, the host allows the values displayed to be much larger without risking lost data due to values on the target wrapping around to 0. If polling of STS data is disabled or very infrequent, there is a possibility that the STS data wraps around, resulting in incorrect information.

While the host clears the values on the target automatically, you can clear the 64-bit objects stored on the host by right-clicking on the STS Data window and choosing Clear from the shortcut menu.

The host read and clear operations are performed with interrupts disabled to allow any thread to update any STS object reliably. For example, an HWI function can call STS_add on an STS object and no data is missing from any STS fields.

This instrumentation process provides minimal intrusion into the target program. A call to STS_add requires approximately 20 instructions on the C5000 platform and 18 instructions on the C6000 platform. Similarly, an STS object uses only eight or four words of data memory on the C5000 or C6000 platforms, respectively. Data filtering, formatting, and computation of the average is done on the host.

You can control the polling rate for statistics information with the RTA Control Panel Property Page. If you set the polling rate to 0, the host does not poll the target for information about the STS objects unless you right-click on the Statistics Data tool and choose Refresh Window from the pop-up menu.

3.5.3.1 Statistics About Varying Values

STS objects can be used to accumulate statistical information about a time series of 32-bit data values.

For example, let P_i be the pitch detected by an algorithm on the i^{th} frame of audio data. An STS object can store summary information about the time series $\{P_i\}$. The following code fragment includes the current pitch value in the series of values tracked by the STS object:

```
pitch = `do pitch detection`
STS_add(&stsObj, pitch);
```

The Statistics Data tool displays the number of values in the series, the maximum value, the total of all values in the series, and the average value.

3.5.3.2 Statistics About Time Periods

In any real-time system, there are important time periods. Since a period is the difference between successive time values, STS provides explicit support for these measurements.

For example, let T_i be the time taken by an algorithm to process the i^{th} frame of data. An STS object can store summary information about the time series $\{T_i\}$. The following code fragment illustrates the use of CLK_gettime (high-resolution time), STS_set, and STS_delta to track statistical information about the time required to perform an algorithm:

```
STS_set(&stsObj, CLK_gettime());
    `do algorithm`
STS_delta(&stsObj, CLK_gettime());
```

STS_set saves the value of CLK_gettime as the contents of the previous value field (set value) in the STS object. STS_delta subtracts this set value from the new value it is passed. The result is the difference between the time recorded before the algorithm started and after it was completed; that is, the time it took to execute the algorithm (T_i). STS_delta then invokes STS_add and passes this result as the new contents of the previous value field to be tracked.

The host can display the count of times the algorithm was performed, the maximum time to perform the algorithm, the total time performing the algorithm, and the average time.

The set value is the fourth component of an STS object. It is provided to support statistical analysis of a data series that consist of value differences, rather than absolute values.

3.5.3.3 Statistics About Value Differences

Both STS_set and STS_delta update the contents of the previous value field in an STS object. Depending on the call sequence, you can measure specific value differences or the value difference since the last STS update. Example 3-1 shows code for gathering information about differences between specific values. Figure 3-3 shows current values when measuring differences from the base value.

Example 3-1 Gathering Information About Differences in Values

```

STS_set(&sts, targetValue); /* T0 */
"processing"
STS_delta(&sts, currentValue); /* T1 */
"processing"
STS_delta(&sts, currentValue); /* T2 */
"processing"
STS_delta(&sts, currentValue); /* T3 */
"processing"
    
```

Figure 3–3 Current Value Deltas From One STS_set

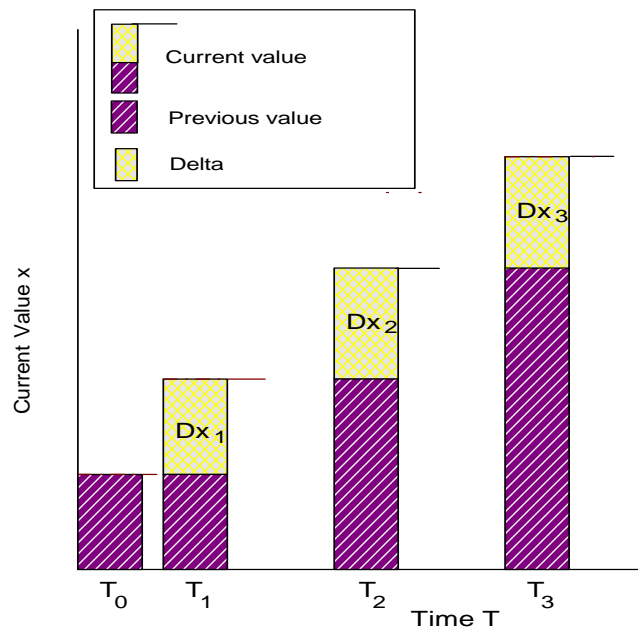

Example 3-2 gathers information about a value's difference from a base value. Figure 3–4 illustrates the current value when measuring differences from a base value.

Example 3-2 Gathering Information About Differences from Base Value

```

STS_set(&sts, baseValue);
"processing"
STS_delta(&sts, currentValue);
STS_set(&sts, baseValue);
"processing"
STS_delta(&sts, currentValue);
STS_set(&sts, baseValue);
"processing"
STS_delta(&sts, currentValue);
STS_set(&sts, baseValue);
"processing"
    
```

Figure 3–4 Current Value Deltas from Base Value

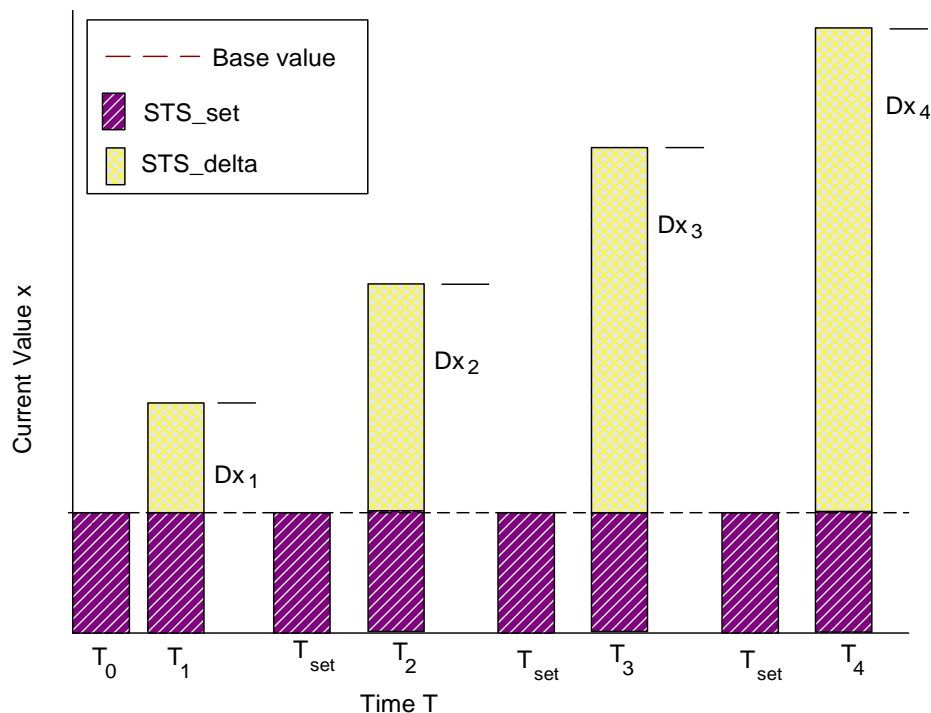

The DSP/BIOS online help describes statistics objects and their parameters. See *STS Module* in the *TMS320 DSP/BIOS API Reference Guide* for your platform for information on the STS module API calls.

3.5.4 Trace Manager (TRC Module)

The TRC module allows an application to enable and disable the acquisition of analysis data in real time. For example, the target can use the TRC module to stop or start the acquisition of data when it discovers an anomaly in the application's behavior.

Control of data gathering is important because it allows you to limit the effects of instrumentation on program behavior, ensure that LOG and STS objects contain the necessary information, and start or stop recording of events and data values at run time.

For example, by enabling instrumentation when an event occurs, you can use a fixed log to store the first *n* events after you enable the log. By disabling tracing when an event occurs, you can use a circular log to store the last *n* events before you disable the log.

3.5.4.1 Control of Explicit Instrumentation

You can use the TRC module to control explicit instrumentation as shown in this code fragment:

```
if (TRC_query(TRC_USER0) == 0) {
    `LOG or STS operation`
}
```

Note: TRC_query returns 0 if all trace types in the mask passed to it are enabled, and is not 0 if any trace types in the mask are disabled.

The overhead of this code fragment is just a few instruction cycles if the tested bit is not set. If an application can afford the extra program size required for the test and associated instrumentation calls, it is very practical to keep this code in the production application simplifying the development process and enabling field diagnostics. This is, in fact, the model used within the DSP/BIOS instrumented kernel.

3.5.4.2 Control of Implicit Instrumentation

The TRC module manages a set of trace bits that control the real-time capture of implicit instrumentation data through logs and statistics objects. For greater efficiency, the target does not store log or statistics information unless tracing is enabled. (You do not need to enable tracing for messages explicitly written with LOG_printf or LOG_event and statistics added with STS_add or STS_delta.)

DSP/BIOS defines constants for referencing specific trace bits as shown in Figure 3–2. The trace bits allow the target application to control when to start and stop gathering system information. This can be important when trying to capture information about a specific event or combination of events.

By default, all TRC constants are enabled. However, TRC_query returns non-zero if either the TRC_GBLHOST or TRC_GBLTARG constants are disabled. This is because no tracing is done unless these bits are set.

Table 3–2. TRC Constants:

Constant	Tracing Enabled/Disabled	Default
TRC_LOGCLK	Logs low-resolution clock interrupts	on
TRC_LOGPRD	Logs system ticks and start of periodic functions	on
TRC_LOGSWI	Logs posting, start, and completion of software interrupt functions	on
TRC_LOGTSK	Logs events when a task is made ready, starts, becomes blocked, resumes execution, and terminates. This constant also logs semaphore posts.	on
TRC_STSHWI	Gathers statistics on monitored register values within HWIs	on
TRC_STSPIP	Counts the number of frames read from or written to data pipe	on
TRC_STSPRD	Gathers statistics on the number of ticks elapsed during execution of periodic functions	on

Constant	Tracing Enabled/Disabled	Default
TRC_STSSWI	Gathers statistics on number of instruction cycles or time elapsed from post to completion of software interrupt	on
TRC_STSTSK	Gather statistics on length of TSK execution from when a task is made ready to run until a call to TSK_deltatime() is made; measured in timer interrupt units or CLK ticks.	on
TRC_USER0 and TRC_USER1	Enables or disables sets of explicit instrumentation actions. You can use TRC_query to check the settings of these bits and either perform or omit calls based on the result. DSP/BIOS does not use or set these bits.	on
TRC_GBLHOST	Simultaneously starts or stops gathering all enabled types of tracing. This bit must be set in order for any implicit instrumentation to be performed. This can be important if you are trying to correlate events of different types. This bit is usually set at run time on the host with the RTA Control Panel.	on
TRC_GBLTARG	Controls implicit instrumentation. This bit must also be set in order for any implicit instrumentation to be performed, and can only be set by the target program.	on

Note: **Updating Task Statistics.** If TSK_deltatime is not called by a task, its statistics will never be updated in the Statistics Data tool, even if TSK accumulators are enabled in the RTA Control Panel.

TSK statistics are handled differently than other statistics because TSK functions typically run an infinite loop that blocks while waiting for other threads. In contrast, HWI and SWI functions run to completion without blocking. Because of this difference, DSP/BIOS allows programs to identify the "beginning" of a TSK function's processing loop by calling TSK_settime and the "end" of the loop by calling TSK_deltatime.

You can enable and disable these trace bits in the following ways:

- From the host, choose **Tools > RTOS Analyzer > RTA (Legacy) > RTA Control Panel** from the CCS menu bar. This panel allows you to adjust the balance between information gathering and time intrusion at run time. By disabling various implicit instrumentation types, you lose information but reduce the overhead of processing.
- From the target code, enable and disable trace bits using the TRC_enable and TRC_disable operations, respectively. For example, the following C code disables tracing of log information for software interrupts and periodic functions:

```
TRC_disable(TRC_LOGSWI | TRC_LOGPRD);
```

For example, in an overnight run you might be looking for a specific circumstance. When it occurs, your program can perform the following statement to turn off all tracing so that the current instrumentation information is preserved:

```
TRC_disable(TRC_GBLTARG);
```

Any changes made by the target program to the trace bits are reflected in the RTA Control Panel. For example, you could cause the target program to disable the tracing of information when an event occurs. On the host, you can simply wait for the global target enable check box to be cleared and then examine the log.

3.6 Implicit DSP/BIOS Instrumentation

The instrumentation needed to allow the DSP/BIOS Analysis Tools to display the raw logs, system statistics, and CPU load are built automatically into a DSP/BIOS program to provide implicit instrumentation. You can enable different components of DSP/BIOS implicit instrumentation by using the RTA Control Panel Analysis Tool in Code Composer, as described in section 3.4.4.2, *Control of Implicit Instrumentation*, page 3-15.

DSP/BIOS instrumentation is efficient—when all implicit instrumentation is enabled, the CPU load increases less than one percent for a typical application. See Section 3.4, *Instrumentation Performance*, page 3-62, for details about instrumentation performance.

3.6.1 The CPU Load

The CPU load is defined as the percentage of instruction cycles that the CPU spends doing application work. That is, the percentage of the total time that the CPU is:

- Running hardware interrupts, software interrupts, tasks, or periodic functions
- Performing I/O with the host
- Running any user routine
- In power-save or hardware idle mode ('C55x only)

When the CPU is not doing any of these, it is considered idle.



Although the CPU is idle during power-save mode, which is supported on 'C55x through the PWRM module, the DSP/BIOS idle loop cannot run. As a result, the CPU load cannot be calculated and is shown as 100%.

To view the CPU Load tool, choose **Tools > RTOS Analyzer > RTA (Legacy) > CPU Load** from the CCS menu bar.

All CPU activity is divided into work time and idle time. To measure the CPU load over a time interval T , you need to know how much time during that interval was spent doing application work (t_w) and how much of it was idle time (t_i). From this you can calculate the CPU load as follows:

$$\text{CPUload} = \frac{t_w}{T} \times 100$$

Since the CPU is always either doing work or in idle it is represented as follows:

$$T = t_w + t_i$$

You can rewrite this equation:

$$\text{CPUload} = \frac{t_w}{t_w + t_i} \times 100$$

You can also express CPU load using instruction cycles rather than time intervals:

$$\text{CPUload} = \frac{c_w}{c_w + c_i} \times 100$$

3.6.1.1 Measuring the CPU Load

In a DSP/BIOS application, the CPU is doing work when any of the following are occurring:

- hardware interrupts are serviced

- software interrupts and periodic functions are run
- task functions are run
- user functions are executed from the idle loop
- HST channels are transferring data to the host
- real-time analysis data is uploaded to the DSP/BIOS Analysis Tools

When the CPU is not performing any of those activities, it is going through the idle loop, executing the IDL_cpuLoad function, and calling the other DSP/BIOS IDL objects. In other words, the CPU idle time in a DSP/BIOS application is the time that the CPU spends doing the routine in Example 3-3.

To measure the CPU load in a DSP/BIOS application over a time interval T, it is sufficient to know how much time was spent going through the loop, shown in Figure 3-3, and how much time was spent doing application work.

Example 3-3 The Idle Loop

```
'Idle_loop:
  Perform IDL_cpuLoad
  Perform all other IDL functions (user/system functions)
  Goto IDL_loop'
```

Over a period of time T, a CPU with M MIPS (million instructions per second) executes M x T instruction cycles. Of those instruction cycles, c_w are spent doing application work. The rest are spent executing the idle loop shown in Example 3-3. If the number of instruction cycles required to execute this loop once is I_1 , the total number of instruction cycles spent executing the loop is $N \times I_1$ where N is the number of times the loop is repeated over the period T. Hence, you have total instruction cycles equals work instruction cycles plus idle instruction cycles.

$$MT = c_w + NI_1$$

From this expression you can rewrite c_w as:

$$c_w = MT - NI_1$$

3.6.1.2 Calculating the Application CPU Load

Using the previous equations, you can calculate the CPU load in a DSP/BIOS application as:

$$\text{CPUload} = \frac{c_w}{MT} \times 100 = \frac{MT - NI_1}{MT} \times 100 = \left(1 - \frac{NI_1}{MT}\right) \times 100$$

To calculate the CPU load you need to know I_1 and the value of N for a chosen time interval T, over which the CPU load is being measured.

The IDL_cpuLoad object in the DSP/BIOS idle loop updates an STS object, IDL_busyObj, that keeps track of the number of times the IDL_loop runs, and the time as kept by the DSP/BIOS high-resolution clock (see Section 4.9, *Timers, Interrupts, and the System Clock*, page 4-137). This information is used by the host to calculate the CPU load according to the equation above.

The host uploads the STS objects from the target at the polling rate set in the RTA Control Panel Property Page. The information contained in IDL_busyObj is used to calculate the CPU load. The IDL_busyObj count provides a measure of N (the number of times the idle loop ran). The IDL_busyObj maximum is not used in CPU load calculation. The IDL_busyObj total provides the value T in units of the high-resolution clock.

To calculate the CPU load you still need to know I_1 (the number of instruction cycles spent in the idle loop). When the Auto calculate idle loop instruction count box is enabled for the Idle Function Manager, DSP/BIOS calculates I_1 at initialization from BIOS_init.

The host uses the values described for N, T, I_1 , and the CPU MIPS to calculate the CPU load as follows:

$$\text{CPUload} = \left[1 - \frac{NI_1}{MT} \right] 100$$

3.6.2 Hardware Interrupt Count and Maximum Stack Depth

You can track the number of times an individual HWI function has been triggered by configuring the monitor parameter for an HWI object to track the stack pointer. An STS object is created automatically for each hardware ISR that is monitored as shown in Figures 3–5 and 3–6.

Figure 3–5 Monitoring Stack Pointers (C5000 platform)

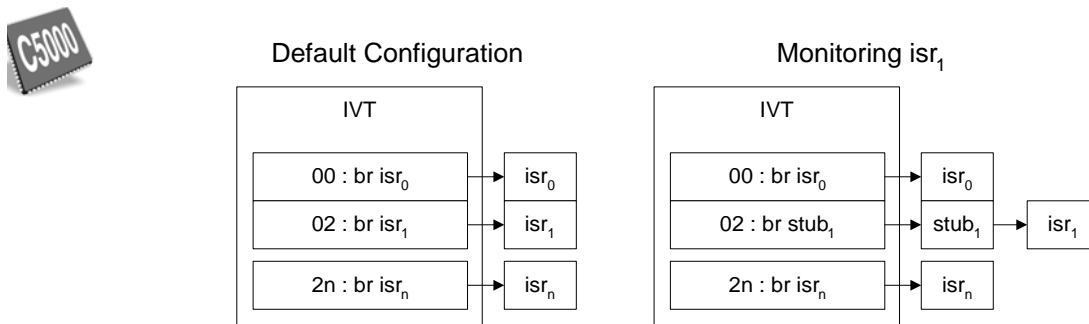
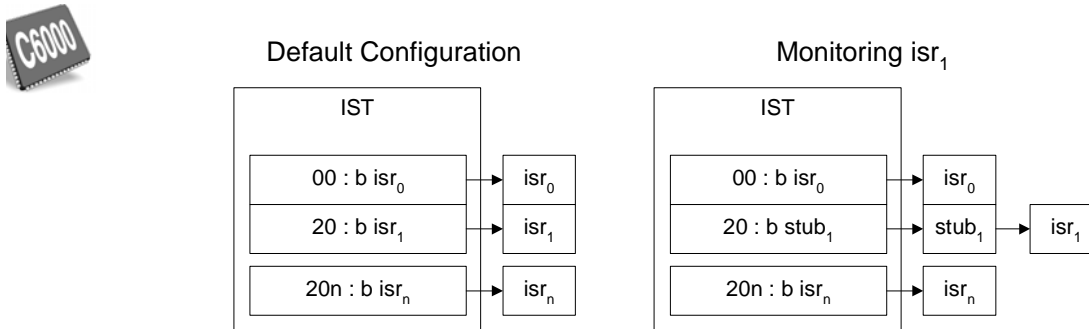

Figure 3–6 Monitoring Stack Pointers (C6000 platform)



For hardware interrupts that are not monitored, there is no overhead—control passes directly to the HWI function. For interrupts that are monitored, control first passes to a stub function generated by the configuration. This function reads the selected data location, passes the value to the selected STS operation, and finally branches to the HWI function.

The enable HWI accumulations check box in the RTA Control Panel must be selected in order for HWI function monitoring to take place. If this type of tracing is not enabled, the stub function branches to the HWI function without updating the STS object.

The number of times an interrupt is triggered is recorded in the Count field of the STS object. When the stack pointer is monitored, the maximum value reflects the maximum position of the top of the system stack when the interrupt occurs. This can be useful for determining the system stack size needed by an application. To determine the maximum depth of the stack, follow these steps (see Figure 3–7):

1. In your .tcf file, set the monitor field for the HWI object to Stack Pointer. You should also change the operation field to STS_add(-*addr).

These changes give you the minimum value of the stack pointer in the maximum field of the STS object. This is the top of the stack, since the stack grows downward in memory.

2. Link your program and use the nmti program, which is described in Chapter 2, *Utility Programs* in the *TMS320 DSP/BIOS API Reference Guide* for your platform, to find the address of the end of the system stack. Or, you can find the address in Code Composer by using a Memory window or the map file to find the address referenced by the GBL_stackend symbol. (This symbol references the top of the stack.)
3. Run your program and view the STS object that monitors the stack pointer for this HWI function in the Statistics Data tool.
4. Subtract the minimum value of the stack pointer (maximum field in the STS object) from the end of the system stack to find the maximum depth of the stack.

ROV displays stack information for all targets. (See Section 3.3, *RTOS Object Viewer (ROV)*)

Figure 3–7 Calculating Used Stack Depth

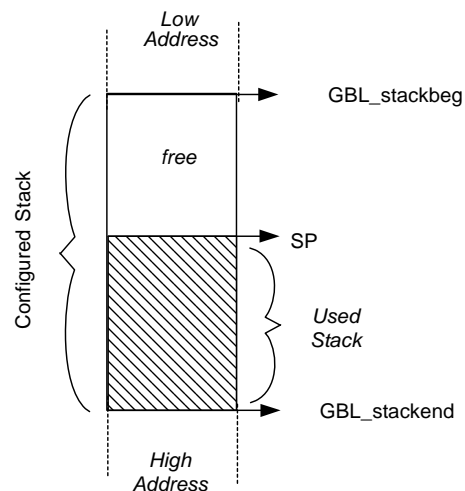

$$\text{used stack depth} = \{\text{GBL_stackend} - \min(\text{SP})\}$$

$$\text{STS_add}(-*\text{addr}) = \min(\text{SP})$$

3.6.3 Monitoring Variables



In addition to counting hardware interrupt occurrences and monitoring the stack pointer, you can monitor any register or data value each time a hardware interrupt is triggered.

This implicit instrumentation can be enabled for any HWI object. Such monitoring is not enabled by default. The performance of your interrupt processing is not affected unless you enable this type of instrumentation in the configuration. The statistics object is updated each time hardware interrupt processing begins. Updating such a statistics object consumes between 20 and 30 instructions per interrupt for each interrupt monitored.

To enable implicit HWI instrumentation:

1. Open the properties window for any HWI object and choose a register to monitor in the monitor field. You can monitor any variable shown in Table 3–3, or you can monitor nothing. When you choose to monitor a variable, the configuration automatically creates an STS object to store the statistics for the variable.

Table 3–3. Variables that can be Monitored with HWI

C55x Platform 			C6000 Platform 			C28x Platform 		
Data Value			Data Value			Data Value		
			Top of system stack					
Stack pointer			Stack Pointer			Stack Pointer		
General purpose register:			General purpose register:			General purpose register:		
ac0	rea1	trn0	a0	a12	b6	ah	ph	xar0
ac1	rptc	trn1	a1	a13	b7	al	pl	xar1
ac2	rsa0	xar0	a2	a14	b8	idp	st0	xar2
ac3	rsa1	xar1	a3	a15	b9	ifr	st1	xar3
brc0	st0	xar2	a4	a16-	b10	ier	t	xar4
brc1	st1	xar3	a5	a31	b11		tl	xar5
ifr0	st2	xar4	a6		b12			xar6
ifr1	st3	xar5	a7	(C64x only)	b13			xar7
imr0	t0	xar6	a8		b14			
imr1	t1	xar7	a9	b0	b1			
reta	t2	xcdp	a10	b1	b16-			
rea0	t3	xdp	a11	b2	b31			
				b3				
				b4	(C64x only)			
				b5				

2. Set the operation parameter to the STS operation you want to perform on this value.

You can perform one of the operations shown in Table 3–4 on the value stored in the variable you select. For all these operations, the number of times this hardware interrupt has been executed is stored in the count field (see Figure 3–2). The max and total values are stored in the STS object on the target. The average is computed on the host.

Table 3–4. STS Operations and Their Results

STS Operation	Result
STS_add(*addr)	Stores maximum and total for the data value or register value
STS_delta(*addr)	Compares the data value or register value to the prev property of the STS object (or a value set consistently with STS_set) and stores the maximum and total differences.
STS_add(-*addr)	Negates the data value or register value and stores the maximum and total. As a result, the value stored as the maximum is the negated minimum value. The total and average are the negated total and average values.
STS_delta(-*addr)	Negates the data value or register value and compares the data value or register value to the prev property of the STS object (or a value set programmatically with STS_set). Stores the maximum and total differences. As a result, the value stored as the maximum is the negated minimum difference.
STS_add(*addr)	Takes the absolute value of the data value or register value and stores the maximum and total. As a result, the value stored as the maximum is the largest negative or positive value. The average is the average absolute value.
STS_delta(*addr)	Compares the absolute value of the register or data value to the prev property of the STS object (or a value set programmatically with STS_set). Stores the maximum and total differences. As a result, the value stored as the maximum is the largest negative or positive difference and the average is the average variation from the specified value.

3. You may also set the properties of the corresponding STS object to filter the values of this STS object on the host.

For example, you might want to watch the top of the system stack to see whether the application is exceeding the allocated stack size. The top of the system stack is initialized to 0xBEEF on the C5000 platform and to 0xC0FFEE on the C6000 platform when the program is loaded. If this value ever changes, the application has either exceeded the allocated stack or some error has caused the application to overwrite the application's stack.

One way to watch for the allocated stack size being exceeded is to follow these steps:

1. In the configuration, enable implicit instrumentation on any regularly occurring HWI function. Change the monitor property for the HWI object to Top of SW Stack with STS_delta(*addr) as the operation.
2. Set the prev property of the corresponding STS object to 0xBEEF on the C5000 and C2800 platform or to 0xC0FFEE on the C6000 platform.
3. Load your program in Code Composer and use the Statistics Data tool to view the STS object that monitors the stack pointer for this HWI function.
4. Run your program. Any change to the value at the top of the stack is seen as a non-zero total (or maximum) in the corresponding STS object.

3.6.4 **Interrupt Latency**

Interrupt latency is the maximum time between the triggering of an interrupt and when the first instruction of the HWI executes. You can measure interrupt latency for the timer interrupt by following the appropriate steps for your platform:



Note: It is currently not possible to calculate interrupt latency on the C5500 using DSP/BIOS because the C55x timer access is outside data space.



1. Configure the HWI object specified by the CPU Interrupt property of the CLK Manager to monitor a Data Value.
2. Set the `addr` parameter to the address of the timer counter register for the on-device timer used by the CLK Manager.
3. Set the `type` to unsigned.
4. Set the `operation` parameter to `STS_add(*addr)`.
5. Set the Host Operation parameter of the corresponding STS object, `HWI_INT14_STS`, to $A * X + B$. Set `A` to 4 and `B` to 0.



1. Configure the `HWI_TINT` object to monitor the `tim` register.
2. Set the `operation` parameter to `STS_add(*addr)`.
3. Set the host operation parameter of the `HWI_TINT_STS` object to $A * x + B$. Set `A` to -1 and `B` to the value of the `PRD` register.

The STS objects `HWI_TINT_STS` (C5000) or `HWI_INT14_STS` (C6000) then display the maximum time (in instruction cycles) between when the timer interrupt was triggered and when the Timer Counter Register was able to be read. This is the interrupt latency experienced by the timer interrupt. The interrupt latency in the system is at least as large as this value.

3.7 Instrumentation for Field Testing

The embedded DSP/BIOS run-time library and DSP/BIOS Analysis Tools support a new generation of testing and diagnostic tools that interact with programs running on production systems. Since DSP/BIOS instrumentation is so efficient, your production program can retain explicit instrumentation for use with manufacturing tests and field diagnostic tools, which can be designed to interact with both implicit and explicit instrumentation.

3.8 Real-Time Data Exchange

Real-Time Data Exchange (RTDX) provides real-time, continuous visibility into the way DSP applications operate in the real world. The RTDX plug-ins allow system developers to transfer data between a host computer and DSP devices without interfering with the target application. The data can be analyzed and visualized on the host using any OLE automation client. This shortens development time by giving you a realistic representation of the way your system actually operates.

Note: RTDX is occasionally not supported for the initial releases of a new DSP device or board.

RTDX consists of both target and host components. A small RTDX software library runs on the target DSP. The DSP application makes function calls to this library's API in order to pass data to or from it. This library makes use of a scan-based emulator to move data to or from the host platform via a JTAG interface. Data transfer to the host occurs in real time while the DSP application is running.

On the host platform, an RTDX host library operates in conjunction with Code Composer Studio. Displays and RTA tools communicate with RTDX via an easy-to-use COM API to obtain the target data and/or to send data to the DSP application. Designers can use their choice of standard software display packages, including:

- LabVIEW from National Instruments
- Real-Time Graphics Tools from Quinn-Curtis
- Microsoft Excel

Alternatively, you can develop your own Visual Basic or Visual C++ applications. Instead of focusing on obtaining the data, you can concentrate on designing the display to visualize the data in the most meaningful way.

3.8.1 RTDX Applications

RTDX is well suited for a variety of control, servo, and audio applications. For example, wireless telecommunications manufacturers can capture the outputs of their vocoder algorithms to check the implementations of speech applications.

Embedded control systems also benefit from RTDX. Hard disk drive designers can test their applications without crashing the drive with improper signals to the servo-motor. Engine control designers can analyze changing factors (like heat and environmental conditions) while the control application is running.

For all of these applications, you can select visualization tools that display information in a way that is most meaningful to you.

3.8.2 RTDX Usage

RTDX can be used with or without DSP/BIOS. RTDX is available with the PC-hosted Code Composer Studio running Windows 98, or Windows NT version 4.0. RTDX in simulation is supported.

This document assumes that the reader is familiar with C, Visual Basic or Visual C++, and OLE/ActiveX programming.

3.8.3 RTDX Flow of Data

Code Composer Studio data flow between the host (PC) and the target (TI processor) as shown in Figure 3–8.

Figure 3–8 RTDX Data Flow between Host and Target

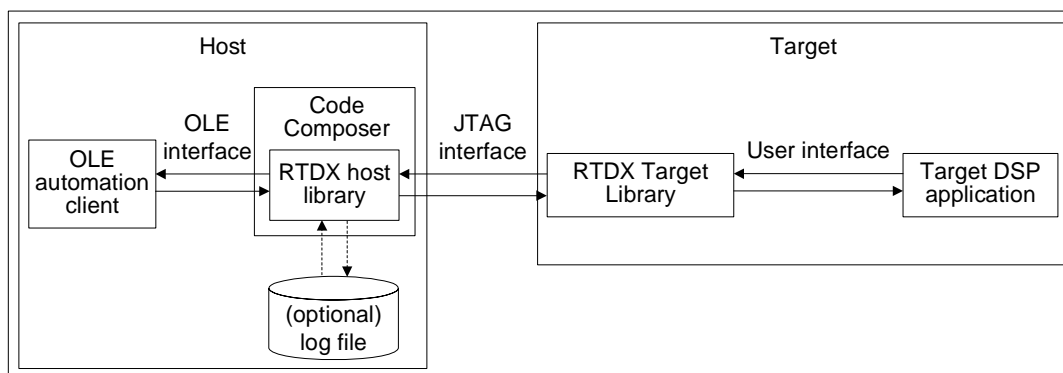

3.8.3.1 Target to Host Data Flow

To record data on the target, you must declare an output channel and write data to it using routines defined in the user interface. This data is immediately recorded into an RTDX target buffer defined in the RTDX target library. The data in the buffer is then sent to the host via the JTAG interface.

The RTDX host library receives this data from the JTAG interface and records it. The host records the data into either a memory buffer or to an RTDX log file (depending on the RTDX host recording mode specified).

The data can be retrieved by any host application that is an OLE automation client. Some typical examples of OLE-capable host applications are:

- Visual Basic applications
- Visual C++ applications
- Lab View
- Microsoft Excel

Typically, an RTDX OLE automation client is a display that allows you to visualize the data in a meaningful way.

3.8.3.2 Host to Target Data Flow

For the target to receive data from the host, you must first declare an input channel and request data from it using routines defined in the user interface. The request for data is recorded into the RTDX target buffer and sent to the host via the JTAG interface.

An OLE automation client can send data to the target using the OLE Interface. All data to be sent to the target is written to a memory buffer within the RTDX host library. When the RTDX host library receives a read request from the target application, the data in the host buffer is sent to the target via the JTAG interface. The data is written to the requested location on the target in real time. The host notifies the RTDX target library when the operation is complete.

3.8.3.3 RTDX Target Library User Interface

The user interface provides the safest method of exchanging data between a target application and the RTDX host library.

The data types and functions defined in the user interface handle the following functions:

- Enable a target application to send data to the RTDX host library
- Enable a target application to request data from the RTDX host library
- Provide data buffering on the target. A copy of your data is stored in a target buffer prior to being sent to the host. This action helps ensure the integrity of the data and minimizes real-time interference.
- Provide interrupt safety. You can call the routines defined in the user interface from within interrupt handlers.
- Ensure correct utilization of the communication mechanism. It is a requirement that only one datum at a time can be exchanged between the host and target using the JTAG interface. The routines defined in the user interface handle the timing of calls into the lower-level interfaces.

3.8.3.4 RTDX Host OLE Interface

The OLE interface describes the methods that enable an OLE automation client to communicate with the RTDX host library.

The functions defined in the OLE interface:

- Enable an OLE automation client to access the data that was recorded in an RTDX log file or is being buffered by the RTDX Host Library
- Enable an OLE automation client to send data to the target via the RTDX host library

3.8.4 **RTDX Modes**

The RTDX host library provides the following modes of receiving data from a target application:

- **Non-continuous.** The data is written to a log file on the host. Noncontinuous mode should be used when you want to capture a finite amount of data and record it in a log file.
- **Continuous.** The data is simply buffered by the RTDX host library; it is not written to a log file. Continuous mode should be used when you want to continuously obtain and display the data from a DSP application, and you don't need to store the data in a log file.

Note: To drain the buffer(s) and allow data to continuously flow up from the target, the OLE automation client must read from each target output channel on a continual basis. Failure to comply with this constraint may cause data flow from the target to cease, thus reducing the data rate, and possibly resulting in channels being unable to obtain data. In addition, the OLE automation client should open all target output channels on startup to avoid data loss to any of the channels.

3.8.5 **Special Considerations When Writing Assembly Code**

The RTDX functionality in the user library interface can be accessed by a target application written in assembly code.

See the *TMS320C55x Optimizing Compiler User's Guide (SPRU281B)* or the *TMS320C6000 Optimizing Compiler User's Guide (SPRU187G)* for information about the C calling conventions, run-time environment, and run-time-support functions applicable to your platform.

3.8.6 **Target Buffer Size**

The RTDX target buffer is used to temporarily store data that is waiting to be transferred to the host. You may want to reduce the size of the buffer if you are transferring only a small amount of data. Alternately, you may need to increase the size of the buffer if you are transferring blocks of data larger than the default buffer size.

You can change the RTDX buffer size in the .tcf configuration file.

3.8.7 **Sending Data From Target to Host or Host to Target**

The user library interface provides the data types and functions for:

- Sending data from the target to the host
- Sending data from the host to the target

The following data types and functions are defined in the header file rtdx.h. They are available via DSP/BIOS or standalone.

- Declaration Macros
 - RTDX_CreateInputChannel

- RTDX_CreateOutputChannel
- Functions
 - RTDX_channelBusy
 - RTDX_disableInput
 - RTDX_disableOutput
 - RTDX_enableOutput
 - RTDX_enableInput
 - RTDX_read
 - RTDX_readNB
 - RTDX_sizeofInput
 - RTDX_write
- Macros
 - RTDX_isInputEnabled
 - RTDX_isOutputEnabled

See the *TMS320 DSP/BIOS API Reference Guide* for your platform for detailed descriptions of all RTDX functions.

Thread Scheduling

This chapter describes the types of threads a DSP/BIOS program can use, their behavior, and their priorities during program execution.

Topic	Page
4.1 Overview of Thread Scheduling	84
4.2 Hardware Interrupts	91
4.3 Software Interrupts	102
4.4 Tasks	112
4.5 The Idle Loop	120
4.6 Power Management	121
4.7 Semaphores	127
4.8 Mailboxes	132
4.9 Timers, Interrupts, and the System Clock	137
4.10 Periodic Function Manager (PRD) and the System Clock	140

4.1 Overview of Thread Scheduling

Many real-time DSP applications must perform a number of seemingly unrelated functions at the same time, often in response to external events such as the availability of data or the presence of a control signal. Both the functions performed and when they are performed are important.

These functions are called threads. Different systems define threads either narrowly or broadly. Within DSP/BIOS, the term is defined broadly to include any independent stream of instructions executed by the DSP. A thread is a single point of control that can contain a subroutine, an interrupt service routine (ISR), or a function call.

DSP/BIOS enables your applications to be structured as a collection of threads, each of which carries out a modularized function. Multithreaded programs run on a single processor by allowing higher-priority threads to preempt lower-priority threads and by allowing various types of interaction between threads, including blocking, communication, and synchronization.

Real-time application programs organized in such a modular fashion—as opposed to a single, centralized polling loop, for example—are easier to design, implement, and maintain.

DSP/BIOS provides support for several types of program threads with different priorities. Each thread type has different execution and preemption characteristics. The thread types (from highest to lowest priority) are:

- **Hardware interrupts (HWI)**, which includes CLK functions
- **Software interrupts (SWI)**, which includes PRD functions
- **Tasks (TSK)**
- **Background thread (IDL)**

These thread types are described briefly in the following section and discussed in more detail in the rest of this chapter.

4.1.1 Types of Threads

The four major types of threads in a DSP/BIOS program are:

- **Hardware interrupts (HWI)**. Triggered in response to external asynchronous events that occur in the DSP environment. An HWI function (also called an interrupt service routine or ISR) is executed after a hardware interrupt is triggered in order to perform a critical task that is subject to a hard deadline. HWI functions are the threads with the highest priority in a DSP/BIOS application. For a DSPs running at 200 MHz, HWIs should be used for application tasks that need to run at frequencies approaching 200 kHz and that need to be completed within deadlines of 2 to 100 microseconds. For faster DSPs, HWIs should be used for task that run at proportionally higher frequencies and have proportionally shorter deadlines. See Section 4.2, *Hardware Interrupts*, page 4-91, for details about hardware interrupts.
- **Software interrupts (SWI)**. Patterned after hardware interrupt (HWIs). While HWIs are triggered by a hardware interrupt, software interrupts are triggered by calling SWI functions from the program. Software interrupts provide additional priority levels between hardware interrupts and TSKs. SWIs handle threads subject to time constraints that preclude them from being run as tasks, but whose deadlines are not as severe as those of hardware ISRs. Like HWI's, SWI's threads always run to completion. Software interrupts should be used to schedule events with deadlines of 100 microseconds or more. SWIs allow HWIs to defer less critical processing to a lower-priority thread, minimizing the time the CPU spends inside an interrupt service routine, where other HWIs can be disabled. See Section 4.3, *Software Interrupts*, page 4-102, for details about software interrupts.
- **Tasks (TSK)**. Tasks have higher priority than the background thread and lower priority than software interrupts. Tasks differ from software interrupts in that they can wait (block) during execution until necessary resources are available. DSP/BIOS provides a number of structures that can be used for inter task communication and synchronization. These structures include queues, semaphores, and mailboxes. See Section 4.4, *Tasks*, page 4-112, for details about tasks.
- **Background thread**. Executes the idle loop (IDL) at the lowest priority in a DSP/BIOS application. After main returns, a DSP/BIOS application calls the startup routine for each DSP/BIOS module and then falls into the idle loop. The idle loop is a continuous loop that calls all functions for the IDL objects. Each function must wait for all others to finish executing before it is called again. The idle loop runs continuously except when it is preempted by higher-priority threads. Only functions that do not have hard deadlines should be executed in the idle loop. See Section 4.5, *The Idle Loop*, page 4-120, for details about the background thread.

There are several other kinds of functions that can be performed in a DSP/BIOS program. These are performed within the context of one of the thread types in the previous list.

- **Clock (CLK) functions.** Triggered at the rate of the on-device timer interrupt. By default, these functions are triggered by a hardware interrupt and are performed as HWI functions. See Section 4.9, *Timers, Interrupts, and the System Clock*, page 4-137, for details.
- **Periodic (PRD) functions.** Performed based on a multiple of either the on-device timer interrupt or some other occurrence. Periodic functions are a special type of software interrupt. See Section 4.10, *Periodic Function Manager (PRD) and the System Clock*, page 4-140, for details.
- **Data notification functions.** Performed when you use pipes (PIP) or host channels (HST) to transfer data. The functions are triggered when a frame of data is read or written to notify the writer or reader. These functions are performed as part of the context of the function that called PIP_alloc, PIP_get, PIP_free, or PIP_put.

4.1.2 Choosing Which Types of Threads to Use

The type and priority level you choose for each thread in an application program has an impact on whether the threads are scheduled on time and executed correctly. DSP/BIOS static configuration makes it easy to change a thread from one type to another.

Here are some rules for deciding which type of object to use for each task to be performed by a program:

- **SWI or TSK versus HWI.** Perform only critical processing within hardware interrupt service routines. HWIs should be considered for processing hardware interrupts (IRQs) with deadlines down to the 5-microsecond range, especially when data may be overwritten if the deadline is not met. Software interrupts or tasks should be considered for events with longer deadlines—around 100 microseconds or more. Your HWI functions should post software interrupts or tasks to perform lower-priority processing. Using lower-priority threads minimizes the length of time interrupts are disabled (interrupt latency), allowing other hardware interrupts to occur.
- **SWI versus TSK.** Use software interrupts if functions have relatively simple interdependencies and data sharing requirements. Use tasks if the requirements are more complex. While higher-priority threads can preempt lower priority threads, only tasks can wait for another event, such as resource availability. Tasks also have more options than SWIs when using shared data. All input needed by a software interrupt's function should be ready when the program posts the SWI. The SWI object's mailbox structure provides a way to determine when resources are available. SWIs are more memory efficient because they all run from a single stack.
- **IDL.** Create background functions to perform noncritical housekeeping tasks when no other processing is necessary. IDL functions do not typically have hard deadlines. Instead, they run whenever the system has unused processor time.
- **CLK.** Use CLK functions when you want a function to be triggered directly by a timer interrupt. These functions run as HWI functions and should take minimal processing time. The default CLK object, PRD_clock, causes a tick for the periodic functions. You can add additional CLK objects to run at the same rate. However, you should minimize the time required to perform all CLK functions because they run as HWI functions.
- **PRD.** Use PRD functions when you want a function to run at a rate based on a multiple of the on-device timer's low-resolution rate or another event (such as an external interrupt). These functions run as SWI functions.
- **PRD versus SWI.** All PRD functions run at the same SWI priority, so one PRD function cannot preempt another. However, PRD functions can post lower-priority software interrupts for lengthy processing routines. This ensures that the PRD_swi software interrupt can preempt those routines when the next system tick occurs and PRD_swi is posted again.

4.1.3 A Comparison of Thread Characteristics

Table 4–1 provides a comparison of the thread types supported by DSP/BIOS.

Table 4–1. Comparison of Thread Characteristics

Characteristic	HWI	SWI	TSK	IDL
Priority	Highest	2nd highest	2nd lowest	Lowest
Number of priority levels	DSP-dependent	15. Periodic functions run at priority of the PRD_swi SWI object. Task scheduler runs at lowest priority.	16 (Including 1 for the ID loop)	1
Can yield and pend	No, runs to completion except for preemption	No, runs to completion except for preemption	Yes	Should not; would prevent PC from getting target information
Execution states	Inactive, ready, running	Inactive, ready, running	Ready, running, blocked, terminated	Ready, running
Scheduler disabled by	HWI_disable	SWI_disable	TSK_disable	Program exit
Posted or made ready to run by	Interrupt occurs	SWI_post, SWI_andn, SWI_dec, SWI_inc, SWI_or	TSK_create	main() exits and no other thread is currently running
Stack used	System stack (1 per program)	System stack (1 per program)	Task stack (1 per task)	Task stack used by default (see Note 1)
Context saved when preempts other thread	Customizable	Certain registers saved to system stack (see Note 2)	Entire context saved to task stack	--Not applicable--
Context saved when blocked	--Not applicable--	--Not applicable--	Saves the C register set (see optimizing compiler user's guide for your platform)	--Not applicable--

Notes: 1) If you disable the TSK Manager, IDL threads use the system stack.

Table 4–2. Comparison of Thread Characteristics (continued)

Characteristic	HWI	SWI	TSK	IDL
Share data with thread via	Streams, queues, pipes, global variables	Streams, queues, pipes, global variables	Streams, queues, pipes, locks, mailboxes, global variables	Streams, queues, pipes, global variables
Synchronize with thread via	--Not applicable--	SWI mailbox	Semaphores, mailboxes	--Not applicable--
Function hooks	No	No	Yes: initialize, create, delete, exit, task switch, ready	No
Static creation	Included in default configuration template	Yes	Yes	Yes
Dynamic creation	Yes (see Note 3)	Yes	Yes	No
Dynamically change priority	No (see Note 4)	Yes	Yes	No
Implicit logging	None	Post and completion events	Ready, start, block, resume, and termination events	None
Implicit statistics	Monitored values	Execution time	Execution time	None

2) See Section 4.3.7, *Saving Registers During Software Interrupt Preemption*, page 4-111, for a list of saved registers.

3) HWI objects cannot be created dynamically because they correspond to DSP interrupts. However, interrupt functions can be changed at run time.

4) When a HWI function calls `HWI_enter`, it can pass a bitmask that indicates which interrupts to enable while the HWI function runs. An enabled interrupt can preempt the HWI function even if the enabled interrupt has a lower priority than the current interrupt.

4.1.4 Thread Priorities

Within DSP/BIOS, hardware interrupts have the highest priority. The priorities among the set of HWI objects are not maintained implicitly by DSP/BIOS. The HWI priority only applies to the order in which multiple interrupts that are ready on a given CPU cycle are serviced by the CPU. Hardware interrupts are preempted by another interrupt unless that interrupt is disabled by resetting the GIE bit in the CSR, or by setting the corresponding bit in the IER.

Figure 4–1 Thread Priorities

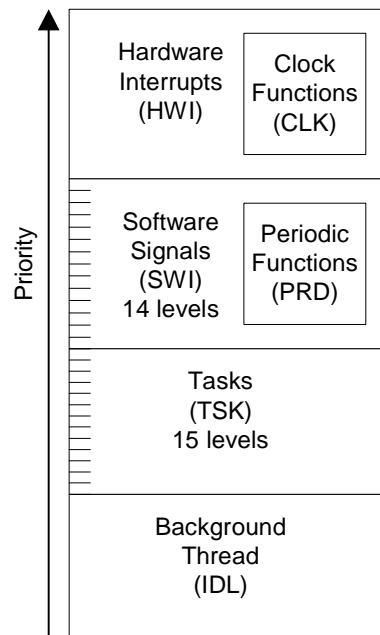

Software interrupts have lower priority than hardware interrupts. There are 14 priority levels available for software interrupts. Software interrupts can be preempted by a higher-priority software interrupt or any hardware interrupt. Software interrupts cannot block.

Tasks have lower priority than software interrupts. There are 15 task priority levels. Tasks can be preempted by any higher-priority thread. Tasks can block while waiting for resource availability and lower-priority threads.

The background idle loop is the thread with the lowest priority of all. It runs in a loop when the CPU is not busy running another thread.

4.1.5 Yielding and Preemption

The DSP/BIOS schedulers run the highest-priority thread that is ready to run except in the following cases:

- The thread that is running disables some or all hardware interrupts temporarily (with `HWI_disable` or `HWI_enter`), preventing hardware ISRs from running.
- The thread that is running disables software interrupts temporarily (with `SWI_disable`). This prevents any higher-priority software interrupt from preempting the current thread. It does not prevent hardware interrupts from preempting the current thread.
- The thread that is running disables task scheduling temporarily (with `TSK_disable`). This prevents any higher-priority task from preempting the current task. It does not prevent software and hardware interrupts from preempting the current task.
- The highest-priority thread is a task that is blocked. This occurs if the task calls `TSK_sleep`, `LCK_pend`, `MBX_pend`, or `SEM_pend`.

Both hardware and software interrupts can interact with the DSP/BIOS task scheduler. When a task is blocked, it is often because the task is pending on a semaphore which is unavailable. Semaphores can be posted from HWIs and SWIs as well as from other tasks. If an HWI or SWI posts a semaphore to unblock a pending task, the processor switches to that task if that task has a higher priority than the currently running task.

When running either an HWI or SWI, DSP/BIOS uses a dedicated system interrupt stack, called the *system stack*. Each task uses its own private stack. Therefore, if there are no TSK tasks in the system, all threads share the same system stack. Because DSP/BIOS uses separate stacks for each task, both the application and task stacks can be smaller. Because the system stack is smaller, you can place it in precious fast memory.

Table 4–3 shows what happens when one type of thread is running (top row) and another thread becomes ready to run (left column). The results depend on whether or not the type of thread that is ready to run is enabled or disabled. (The action shown is that of the thread that is ready to run.)

Table 4–3. Thread Preemption

Thread Posted	Thread Running			
	HWI	SWI	TSK	IDL
Enabled HWI	Preempts	Preempts	Preempts	Preempts
Disabled HWI	Waits for reenable	Waits for reenable	Waits for reenable	Waits for reenable
Enabled, higher-priority SWI	—	Preempts	Preempts	Preempts
Disabled SWI	Waits	Waits for reenable	Waits for reenable	Waits for reenable
Lower priority SWI	Waits	Waits	—	—
Enabled, higher-priority TSK	—	—	Preempts	Preempts
Disabled TSK	Waits	Waits	Waits for reenable	Waits for reenable
Lower priority TSK	Waits	Waits	Waits	—

Figure 4–2 shows the execution graph for a scenario in which SWIs and HWIs are enabled (the default), and a hardware interrupt routine posts a software interrupt whose priority is higher than that of the software interrupt running when the interrupt occurs. Also, a second hardware interrupt occurs while the first ISR is running. The second ISR is held off because the first ISR masks off (that is, disables) the second interrupt during the first ISR.

Figure 4–2 Preemption Scenario

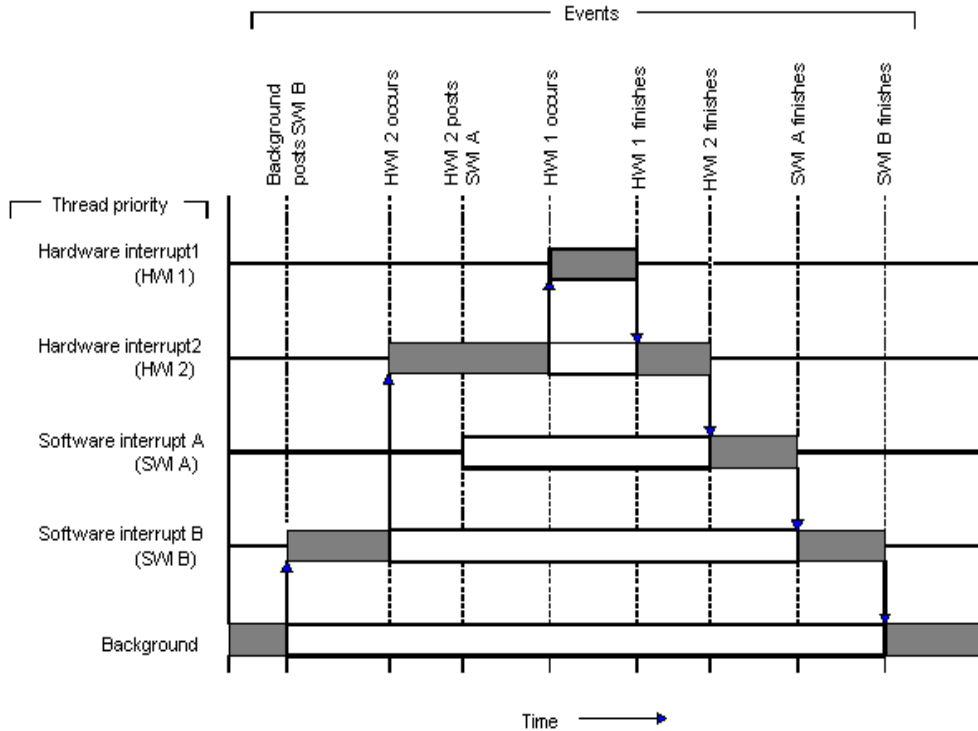

In Figure 4–2, the low priority software interrupt is asynchronously preempted by the hardware interrupts. The first ISR posts a higher-priority software interrupt, which is executed after both hardware interrupt routines finish executing.

4.2 Hardware Interrupts

Hardware interrupts handle critical processing that the application must perform in response to external asynchronous events. The DSP/BIOS HWI module is used to manage hardware interrupts.

In a typical DSP system, hardware interrupts are triggered either by on-device peripherals or by devices external to the DSP. In both cases, the interrupt causes the processor to vector to the ISR address. The address to which a DSP/BIOS HWI object causes an interrupt to vector can be a user routine or the common system HWI dispatcher.

Hardware ISRs can be written using assembly language, C, or a combination of both. HWI functions are usually written in assembly language for efficiency. To allow an HWI object’s function to be written completely in C, the system HWI dispatcher should be used.

All hardware interrupts run to completion. If an HWI is posted multiple times before its ISR has a chance to run, the ISR runs only one time. For this reason, you should minimize the amount of code performed by an HWI function. If the GIE bit is enabled, a hardware interrupt can be preempted by any interrupt that is enabled by the IEMASK.

If an HWI function calls any of the PIP APIs—PIP_alloc, PIP_free, PIP_get, PIP_put—the pipe’s notifyWriter or notifyReader functions run as part of the HWI context.

Note: The *interrupt* keyword or INTERRUPT pragma must **not** be used when HWI objects are used in conjunction with C functions. The HWI_enter/HWI_exit macros and the HWI dispatcher contain this functionality, and the use of the C modifier can cause program failure.

4.2.1 Configuring Interrupts

In the base DSP/BIOS configuration, the HWI Manager contains an HWI object for each hardware interrupt in your DSP.

You can configure the ISR for each hardware interrupt in the DSP. You enter the name of the ISR that is called in response to a hardware interrupt for the corresponding HWI object in the .tcf configuration file. DSP/BIOS takes care of setting up the interrupt table so that each hardware interrupt is handled by the appropriate ISR. You can also configure the memory segment where the interrupt table is located.

The DSP/BIOS online help describes HWI objects and their parameters. See *HWI Module* in the *TMS320 DSP/BIOS API Reference Guide* for your platform for reference information on the HWI module API calls.

4.2.2 Disabling and Enabling Hardware Interrupts

Within a software interrupt or task, you can temporarily disable hardware interrupts during a critical section of processing. The HWI_disable and HWI_enable/HWI_restore functions are used in pairs to disable and enable interrupts.

When you call HWI_disable, interrupts are globally disabled in your application. On the C6000 platform, HWI_disable clears the GIE bit in the control status register (CSR). On the C5000 and C2800 platforms, HWI_disable sets the INTM bit in the ST1 register. On both platforms, this prevents the CPU from taking any maskable hardware interrupt. Hardware interrupts, therefore, operate on a global basis, affecting all interrupts, as opposed to affecting individual bits in the interrupt enable register. To reenabling interrupts, call HWI_enable or HWI_restore. HWI_enable always enables the GIE bit on the C6000 platform or clears the INTM bit in the ST1 register on the C5000 and C2800 platforms, while HWI_restore restores the value to the state that existed before HWI_disable was called.

4.2.3 Impact of Real-Time Mode Emulation on DSP/BIOS

TI Emulation supports two debug execution control modes:

- Stop mode
- Real-time mode

Stop mode provides complete control of program execution, allowing for disabling of all interrupts. Real-time mode allows time-critical interrupt service routines to be performed while execution of other code is halted. Both execution modes can suspend program execution at break events, such as occurrences of software breakpoint instructions or specified program space or data-space accesses.

In real-time mode, background codes are suspended at break events while continuing to execute the time-critical interrupt service routines (also referred to as foreground code.)

4.2.3.1 Interrupt Behavior for C28x During Real-Time Mode

Real-time mode for C28x is defined by three different states:

- Debug Halt state
- Single Instruction state
- Run state

Debug Halt State: This state is entered through a break event, such as the decoding of a software breakpoint instruction or the occurrence of an analysis breakpoint/watchpoint or a request from the host processor.

When halted, time-critical interrupts can still be serviced. An interrupt is defined as time critical interrupt/real-time interrupt if the interrupt has been enabled in the IER and DBGIER register. Note that the INTM bit is ignored in this case.

However, the DBGM bit can be used to prevent the CPU from entering the halt state (or perform debug access) in undesirable regions of code. If INTM and DBGM are used together, then it is possible to protect regions of code from being interrupted by any type of interrupt. It also ensures that debugger updates of registers/memory cannot occur in that region of code.

```
SETC INTM, DEGM  
/ Uninterruptable, unhaltable region of code  
CLRC INTM, DBGM
```

If the breakpoint is present in real-time, it halts the CPU and causes it to enter into DEBUG HALT mode. This is identical to the behavior of breakpoints when in stopmode. Note that software breakpoints replace the original instruction -- so it is not possible to safely ignore or delay the software breakpoint's execution; otherwise, you will not be executing the intended set of instructions. However, other forms of causes of halting the CPU can be delayed. It's important to note that placing software breakpoints is a "deliberate act" -- you know exactly where you are going to halt, whereas with other forms of halting (such as via the CCS Halt command or a watchpoint or other triggering event), the user will often not know where in the program execution the halt will occur.

The user should never place breakpoints in locations where interrupts or halts are forbidden. However, it is possible that a halt from CCS could be initiated when the CPU is in the uninterruptible, unhaltable region of code, in which case the halt will be delayed until DBGM is no longer set. This is just like an interrupt, which will be delayed until INTM is no longer set.

As an example, assume there is a variable called Semaphore, which is incremented in an ISR, and decremented in the main loop. Because of the way interrupts and debug accesses are handled, neither can occur in the italicized regions below:

Example 4-1 Interrupt Behavior for C28x During Real-Time Mode

```

MAIN_LOOP:
; Do some stuff

SETC INTM, DBGM
/ Uninterruptible, unhaltable region of code
MOV ACC, @Semaphore
SUB ACC, #1 ;Let's do "*Semaphore--;" really inefficiently!
MOV @Semaphore, ACC
CLRC INTM, DBGM

; Do some more stuff
B MAIN_LOOP

; By default, INTM and DBGM are set in an ISR so you can't halt or interrupt
RT_ISR:

; Do some stuff
MOV ACC, @Semaphore
ADD ACC, #1 ;Let's do "*Semaphore--;" really inefficiently!
MOV @Semaphore, ACC
; Do some more stuff
IRET

```

Note: The code above is safe if the debugger issues a halt; you cannot halt in the italicized regions above, so the PC will always be at the B MAIN_LOOP instruction. If the user sets a watchpoint to occur when the address Semaphore is accessed, the CPU will not be able to halt until after CLRC INTM, DBGM is executed. The same result will occur if the user sets a hardware breakpoint on RT_ISR. If the user sets a software breakpoint in the italicized regions above, the CPU will halt, but the debugger will report this as an error and indicate that this is an improper operation. In this case, an atomic C28x instruction, such as DEC or INC, should have been used.

Figure 4–3 The Interrupt Sequence in Debug Halt State

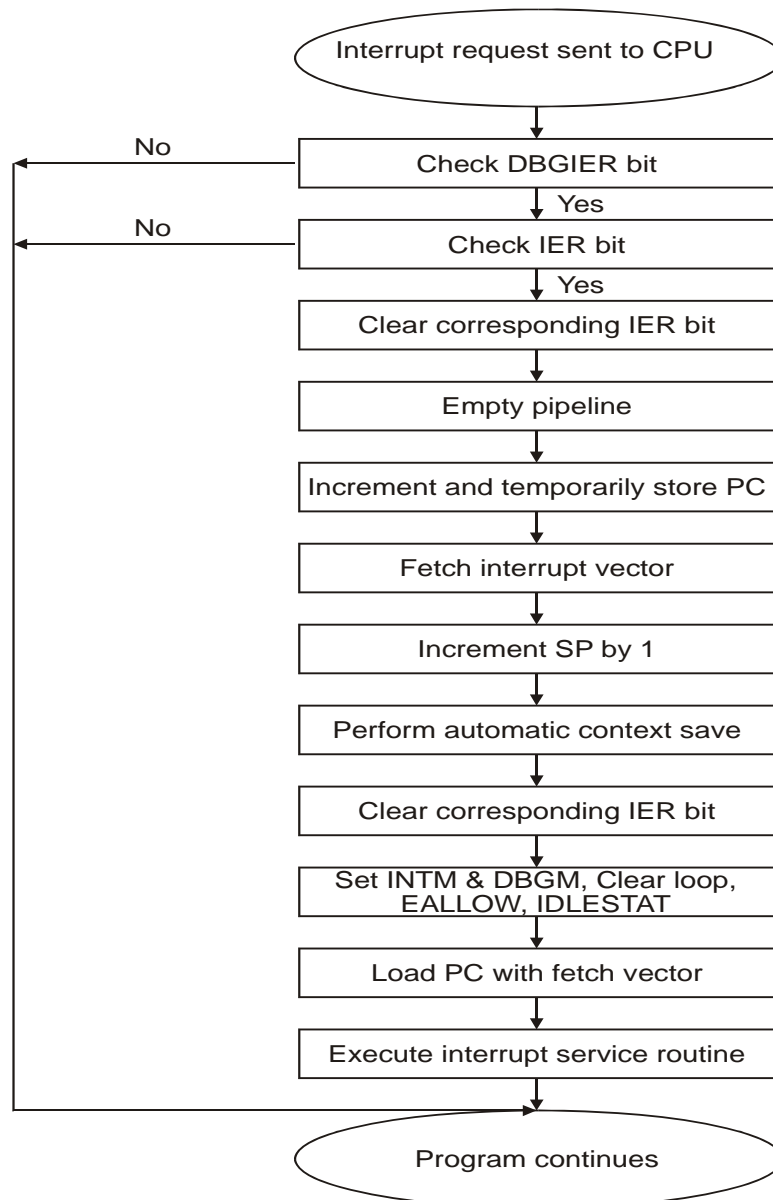

Single Instruction State: This state is entered when you tell the debugger to execute a single instruction by using RUN 1 or a STEP 1 command. The CPU executes the single instruction pointed to by PC and then returns to the debug halt state. If an interrupt occurs in this state and RUN 1 command was used to enter the state, CPU can service the interrupt. However, if STEP 1 was used to enter the state, CPU cannot service the interrupt. This is true for both stop mode and real-time mode.

Note that it is safe to assume that INTM will be respected while single-stepping. Also, if you single-step the code from the previous example, all of the uninterruptible, unhaltable code will be executed as "one instruction" as follows:

```
PC initially here -> SETC INTM, DBGM
; Uninterruptible, unhaltable region of code
MOV ACC, @Semaphore
SUB ACC, #1 ;Let's do "*Semaphore--;" really inefficiently!
MOV @Semaphore, ACC
CLRC INTM, DBGM

; Do some more stuff
PC will stop here -> B MAIN_LOOP
```

Run State: This state is entered when you use a run command from the debugger interface. CPU services all the interrupts, depending on the INTM bit and the IER register value.

Figure 4–4 The Interrupt Sequence in the Run-time State

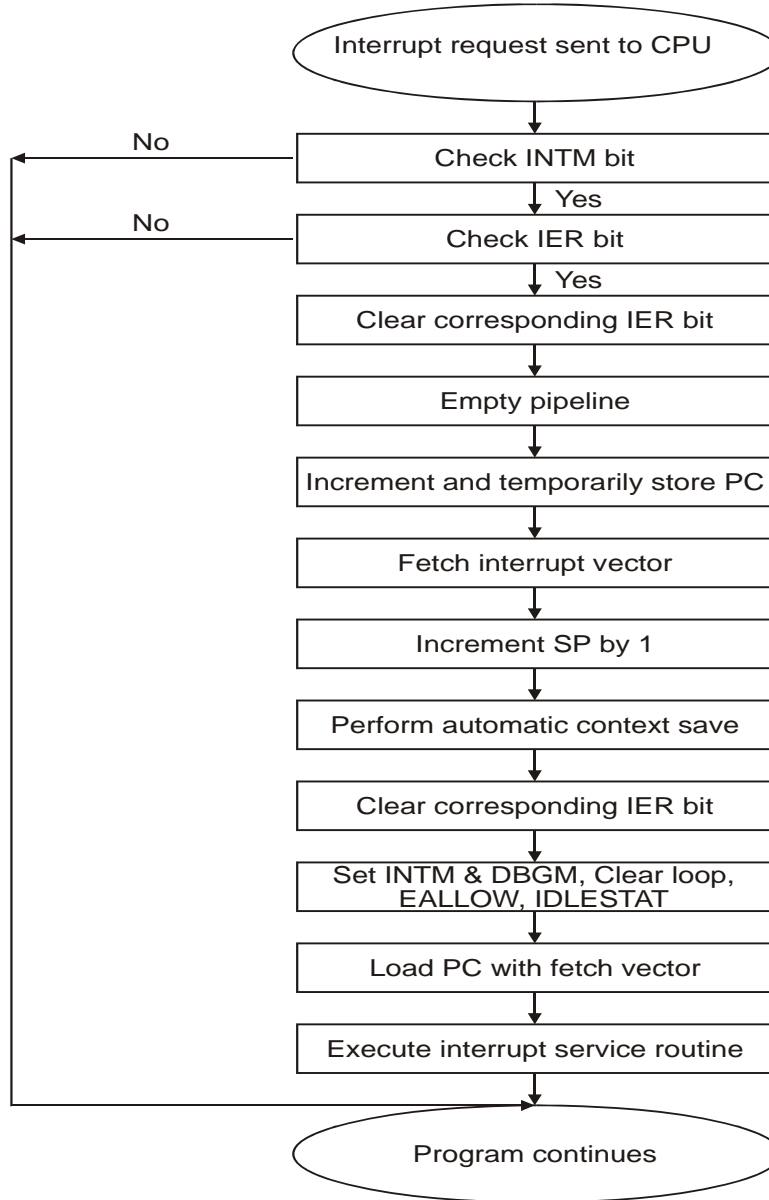

DSP/BIOS has some code segments that need to be protected from interrupts; these code sections are called critical sections. If these segments are interrupted, and interrupt calls some DSP/BIOS API, it is bound to corrupt the program results. Therefore, it is important to surround the code with SET INTM, DBGM and CLRC INTM, DBGM.

Example 4-2 shows two code examples of regions protected from all interrupts.

Example 4-2 Code Regions That are Uninterruptible

(a) Assembly Code

```

.include hwi.h55
...
HWI_disable A ; disable all interrupts, save the old intm
value in reg A
    'do some critical operation'
HWI_restore A0
    
```

(b) C Code

```

#include hwi.h
Uns oldmask;

oldmask = HWI_disable();
    'do some critical operation; '
    'do not call TSK_sleep(), SEM_post, etc.'
HWI_restore(oldmask);
    
```

Using `HWI_restore` instead of `HWI_enable` allows the pair of calls to be nested. If the calls are nested, the outermost call to `HWI_disable` turns interrupts off, and the innermost call to `HWI_disable` does nothing. Interrupts are not reenabled until the outermost call to `HWI_restore`. Be careful when using `HWI_enable` because this call enables interrupts even if they were already disabled when `HWI_disable` was called.

Note: DSP/BIOS kernel calls that can cause task rescheduling (for example, `SEM_post` and `TSK_sleep`) should be avoided within a block surrounded by `HWI_disable` and `HWI_enable` since the interrupts can be disabled for an indeterminate amount of time if a task switch occurs.

4.2.4 Context and Interrupt Management Within Interrupts

When a hardware interrupt preempts the function that is currently executing, the HWI function must save and restore any registers it uses or modifies. DSP/BIOS provides the `HWI_enter` assembly macro to save registers and the `HWI_exit` assembly macro to restore registers. Using these macros gives the function that was preempted the same context when it resumes running. In addition to the register context saving/restoring functionality, the `HWI_enter`/`HWI_exit` macros perform the following system level operations:

- ensure the SWI and TSK schedulers are called at the appropriate times
- disable/restore individual interrupts while the ISR executes

The `HWI_enter` assembly macro must be called prior to any DSP/BIOS API calls that could post or affect a software interrupt or semaphore. The `HWI_exit` assembly macro must be called at the very end of the function's code.

In order to support interrupt routines written completely in C, DSP/BIOS provides an HWI dispatcher that performs these enter and exit macros for an interrupt routine. An HWI can handle context saving and interrupt disabling using this HWI dispatcher or by explicitly calling `HWI_enter` and `HWI_exit`. The HWI configuration properties allow you to choose whether the HWI dispatcher is used for individual HWI objects. The HWI dispatcher is the preferred method for handling interrupts.

The HWI dispatcher, in effect, calls the configured HWI function from within an `HWI_enter`/`HWI_exit` macro pair. This allows the HWI function to be written completely in C. It would, in fact, cause a system crash were the dispatcher to call a function that contains the `HWI_enter`/`HWI_exit` macro pair. Using the dispatcher therefore allows for only one instance of the `HWI_enter` and `HWI_exit` code.

Note: The *interrupt* keyword or `INTERRUPT` pragma must **not** be used when HWI objects are used in conjunction with C functions. The `HWI_enter`/`HWI_exit` macros and the HWI dispatcher contain this functionality, and the use of the C modifier can cause program failure.

Whether called explicitly, C55 or by the HWI dispatcher, the `HWI_enter` and `HWI_exit` macros prepare an ISR to call any C function. In particular, the ISR is prepared to call any DSP/BIOS API function that is allowed to be called from the context of an HWI. (See *Functions Callable by Tasks, SWI Handlers, or Hardware ISRs* in the *TMS320 DSP/BIOS API Reference Guide* for your platform for a complete list of these functions.)

Note: When using the system HWI dispatcher on the C6000 platforms, the HWI function must not call `HWI_enter` and `HWI_exit`.

Regardless of which HWI dispatching method is used, DSP/BIOS uses the system stack during the execution of both SWIs and HWIs. If there are no TSK tasks in the system, this system stack is used by all threads. If there are TSK tasks, each task uses its own private stack. Whenever a task is preempted by an SWI or HWI, DSP/BIOS uses the system stack for the duration of the interrupt thread.



The C55x platform can have seven parameters in all, the first five specify which CPU registers to save as context, and the last two can specify two interrupt mask bitmaps.



`HWI_enter` and `HWI_exit` both take four parameters on the C6000 platform:

- The first two, `ABMASK` and `CMASK`, specify which A, B, and control registers are to be saved and restored by the ISR.
- The third parameter on the C6000 platform, `IEMASK`, is a mask of those interrupts that are to be disabled between the `HWI_enter` and `HWI_exit` macro calls.

When an interrupt is triggered, the processor disables interrupts globally (by clearing the GIE bit in the control status register (CSR)) and then jumps to the ISR set up in the interrupt service table. The `HWI_enter` macro reenables interrupts by setting the GIE in the CSR. Before doing so, `HWI_enter` selectively disables bits in the interrupt enable register (IER) determined by the `IEMASK` parameter. Hence, `HWI_enter` gives you control to select what interrupts can and cannot preempt the current HWI function.

When `HWI_exit` is called, the bit pattern in the `IEMASK` determines what interrupts are restored by `HWI_exit` by setting the corresponding bits in the `IER`. Of the interrupts in `IEMASK`, `HWI_exit` restores only those that were disabled with `HWI_enter`. If upon exiting the ISR you do not want to restore one of the interrupts that was disabled with `HWI_enter`, do not set that interrupt bit in `IEMASK` in `HWI_exit`. `HWI_exit` does not affect the status of interrupt bits that are not in `IEMASK`.

- The fourth parameter on the C6000 platform, `CCMASK`, specifies the value to place in the cache control field of the CSR. This cache state remains in effect for the duration of code executed between the `HWI_enter` and `HWI_exit` calls. Some typical values for this mask are defined in `c62.h62` (for example, `C62_PCC_ENABLE`). You can OR the PCC code and DCC code together to generate `CCMASK`. If you use 0 as `CCMASK`, a default value is used. You set this value using GBL properties in the `.tcf` configuration file.

`CLK_F_isr`, which handles one of the on-device timer interrupts when the Clock Manager is enabled, also uses the cache value set in the configuration. `HWI_enter` saves the current CSR status before it sets the cache bits as defined by `CCMASK`. `HWI_exit` restores CSR to its value at the interrupted context.



The predefined masks `C62_ABTEMPS` and `C62_CTEMPS` (C62x) or `C64_ABTEMPS` and `C64_CTEMPS` (C64x) specify all of the C language temporary A/B registers and all of the temporary control registers, respectively. These masks can be used to save the registers that can be freely used by a C function. When using the HWI dispatcher on the C6000 platform, there is no ability to specify a register set, so the registers specified by these masks are all saved and restored.

For example, if your HWI function calls a C function you would use:

```
HWI_enter C62_ABTEMPS, C62_CTEMPS, IEMASK, CCMASK
`isr code`
HWI_exit C62_ABTEMPS, C62_CTEMPS, IEMASK, CCMASK
```

`HWI_enter` should be used to save all of the C run-time environment registers before calling any C or DSP/BIOS functions. `HWI_exit` should be used to restore these registers.

In addition to saving and restoring the C run-time environment registers, `HWI_enter` and `HWI_exit` make sure the DSP/BIOS scheduler is called only by the outermost interrupt routine if nested interrupts occur. If the HWI or another nested HWI triggers an SWI handler with `SWI_post`, or readies a higher priority task (for example, by calling `SEM_ipost` or `TSK_itick`), the outermost `HWI_exit` invokes the SWI and TSK schedulers. The SWI scheduler services all pending SWI handlers before performing a context switch to a higher priority task (if necessary).



`HWI_enter` and `HWI_exit` both take four parameters on the C2800 platform:

- The first parameter, `AR_MASK`, specifies which CPU registers (`xar0-xar7`) are to be saved and restored by the ISR.
- The second parameter of `HWI_enter` and `HWI_exit` on the C28x platform, `ACC_MASK`, specifies the mask of `ACC`, `p`, and `t` registers to be stored and restored by the ISR.
- The third parameter, `MISC_MASK`, specifies the mask of registers `ier`, `ifr`, `DBGIER`, `st0`, `st1`, and `dp`.
- The fourth parameter, `IERDISABLEMASK`, specifies which bits in the `IER` are to be turned off.

When an interrupt is triggered, the processor switches off `IER` bits and disables interrupts globally (by setting the `INTM` bit in the status register `ST1`) and then jumps to the ISR setup in the interrupt vector table. The `HWI_enter` macro reenables interrupts by clearing the `INTM` bit in the `ST1` register. Before doing so, `HWI_enter` selectively disables some interrupts by clearing the appropriate bits in the Interrupt Enable Register (`IER`). The bits that are cleared in the `IER` register are determined by the

IERDISABLEMASK input parameter passed as fourth parameter to the HWI_enter macro. Hence, HWI_enter gives you control to select what interrupts can and cannot preempt the current HWI function. When HWI_exit is called, you can also provide the IERRESTOREMASK parameter. The bit pattern in the IERRESTOREMASK determines what interrupts are restored by HWI_exit, by setting the corresponding bits in the IER. Of the interrupts in IERRESTOREMASK, HWI_exit restores only those that were disabled with HWI_enter. If upon exiting the ISR you do not wish to restore one of the interrupts that was disabled with HWI_enter, do not set that interrupt bit in the IERRESTOREMASK in HWI_exit. HWI_exit does not affect the status of interrupt bits that are not in IERRESTOREMASK.

See *Functions Callable by Tasks, SWI Handlers, or Hardware ISRs* in the *TMS320 DSP/BIOS API Reference Guide* for your platform for a complete list of functions that can be called by an ISR.

Note: HWI_enter and HWI_exit must surround all statements in any DSP/BIOS assembly or C language HWIs that reference DSP/BIOS functions. Using the HWI dispatcher satisfies this requirement.

Example 4-3 provides assembly language code for constructing a minimal HWI on the C6000 platform when the user has selected not to use the HWI dispatcher. An example on the C55x platform is shown in Example 4-4. These examples use HWI_enter and give you more precise control.

Example 4-3 Constructing a Minimal ISR on C6000 Platform



```

;
; ===== myclk.s62 =====
;
;   .include "hwi.h62" ; macro header file

IEMASK      .set 0
CCMASK      .set c62_PCC_DISABLE
             .text

;
; ===== myclkisr =====
;
;   global _myclkisr
_myclkisr:

; save all C run-time environment registers
HWI_enter C62_ABTEMPS, C62_CTEMPS, IEMASK, CCMASK

b           _TSK_itick ; call TSK_itick (C function)
mvkl       tiret, b3
mvkh       tiret, b3

nop        3

tiret:

; restore saved registers and call DSP/BIOS scheduler
HWI_exit C62_ABTEMPS, C62_CTEMPS, IEMASK, CCMASK

.end

```

Example 4-4 HWI Example on C55x Platform



```

;
; ===== _DSS_isr =====
;
_DSS_isr:
    HWI_enter C55_AR T SAVE BY CALLER MASK,
              C55_ACC SAVE BY CALLER MASK,
              C55_MISC1_SAVE_BY_CALLER_MASK,
              C55_MISC2_SAVE_BY_CALLER_MASK,
              C55_MISC3_SAVE_BY_CALLER_MASK,
              0FFF7h,0
              ; macro has ensured 'C' convention,
              ; including SP alignment!
    call      _DSS_cisr
    HWI_exit  C55_AR T SAVE BY CALLER MASK,
              C55_ACC SAVE BY CALLER MASK,
              C55_MISC1_SAVE_BY_CALLER_MASK,
              C55_MISC2_SAVE_BY_CALLER_MASK,
              C55_MISC3_SAVE_BY_CALLER_MASK,
              0FFF7h,0
    
```

Example 4-5 HWI Example on C28x Platform



```

;
; ===== _DSS_isr =====
;
_DSS_isr:
    HWI_enter  AR_MASK,ACC_MASK,MISC_MASK,IERDISABLEMASK
    lcr        _DSS_cisr
    HWI_exit   AR_MASK,ACC_MASK,MISC_MASK,IERDISABLEMASK
    
```

4.2.5 Registers

DSP/BIOS registers saved and restored with C functions conform to standard C compiler code. For more information, either about which registers are saved and restored, or by the TMS320 functions conforming to the Texas Instruments C run-time model, see the optimizing compiler user's guide for your platform.

4.3 Software Interrupts

Software interrupts are patterned after hardware ISRs. The SWI module in DSP/BIOS provides a software interrupt capability. Software interrupts are triggered programmatically, through a call to a DSP/BIOS API such as `SWI_post`. Software interrupts have priorities that are higher than tasks but lower than hardware interrupts.

The SWI module should not be confused with the SWI instruction that exists on many processors. The DSP/BIOS SWI module is independent from any processor-specific software interrupt features.

SWI threads are suitable for handling application tasks that occur at slower rates or are subject to less severe real-time deadlines than those of hardware interrupts.

The DSP/BIOS APIs that can trigger or post a software interrupt are:

- `SWI_andn`
- `SWI_dec`
- `SWI_inc`
- `SWI_or`

- SWI_post

The SWI Manager controls the execution of all software interrupts. When the application calls one of the APIs above, the SWI Manager schedules the function corresponding to the software interrupt for execution. To handle all software interrupts in an application, the SWI Manager uses SWI objects.

If a software interrupt is posted, it runs only after all pending hardware interrupts have run. An SWI routine in progress can be preempted at any time by an HWI; the HWI completes before the SWI handler resumes. On the other hand, SWI handlers always preempt tasks. All pending software interrupts run before even the highest priority task is allowed to run. In effect, an SWI handler is like a task with a priority higher than all ordinary tasks.

Note: Two things to remember about SWI are:

An SWI handler runs to completion unless it is interrupted by a hardware interrupt or preempted by a higher priority SWI.

When called within an HWI ISR, the code sequence calling any of the SWI functions which can trigger or post a software interrupt must be either wrapped within an HWI_enter/HWI_exit pair or invoked by the HWI dispatcher.

4.3.1 Creating SWI Objects

As with many other DSP/BIOS objects, you can create SWI objects either dynamically (with a call to SWI_create) or statically (in the configuration). Software interrupts you create dynamically can also be deleted during program execution.

To add a new software interrupt to the configuration, create a new SWI object in the .tcf configuration file. Set the function property for each software interrupt to run a function when the object is triggered by the application. You can also configure up to two arguments to be passed to each SWI function.

You can determine from which memory segment SWI objects are allocated. SWI objects are accessed by the SWI Manager when software interrupts are posted and scheduled for execution.

The DSP/BIOS online help describes SWI objects and their properties. See *SWI Module* in the *TMS320 DSP/BIOS API Reference Guide* for your platform for reference information on the SWI module API calls.

To create a software interrupt dynamically, use a call with this syntax:

```
swi = SWI_create(attrs);
```

Here, swi is the interrupt handle and the variable attrs points to the SWI attributes. The SWI attribute structure (of type SWI_Attrs) contains all those elements that can be statically configured for an SWI. attrs can be NULL, in which case, a default set of attributes is used. Typically, attrs contains at least a function for the handler.

Note: SWI_create can only be called from the task level, not from an HWI or another SWI.

SWI_getattrs can be used to retrieve all the SWI_Attrs attributes. Some of these attributes can change during program execution, but typically they contain the values assigned when the object was created.

```
SWI_getattrs(swi, attrs);
```

4.3.2 Setting Software Interrupt Priorities

There are different priority levels among software interrupts. You can create as many software interrupts as your memory constraints allow for each priority level. You can choose a higher priority for a software interrupt that handles a thread with a shorter real-time deadline, and a lower priority for a software interrupt that handles a thread with a less critical execution deadline.

To set software interrupt priorities with the Configuration Tool, follow these steps:

1. In the Configuration Tool, highlight the Software Interrupt Manager. Notice SWI objects in the middle pane of the window shown in Figure 4–5. They are organized in priority level folders. (If you do not see a list of SWI objects in the middle pane, right-click on the SWI Manager, then choose **View > Ordered collection view**.)

Figure 4–5 Software Interrupt Manager

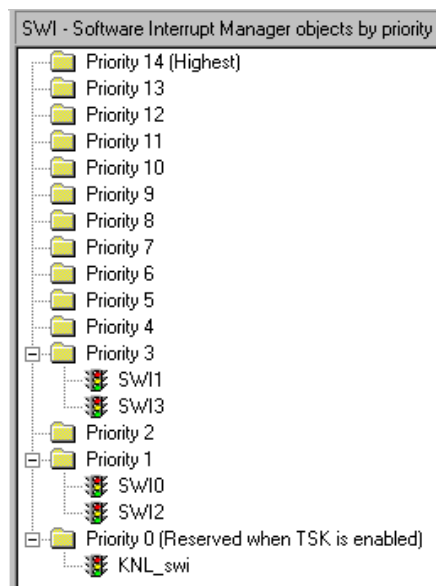

2. To change the priority of a SWI object, drag the software interrupt to the folder of the corresponding priority. For example, to change the priority of SWI0 to 3, select it with the mouse and drag it to the folder labeled Priority 3.

Software interrupts can have up to 15 priority levels. The highest level is SWI_MAXPRI (14). The lowest is SWI_MINPRI (0). The priority level of 0 is reserved for the KNL_swi object, which runs the task scheduler. See Section 4.3.3, *Software Interrupt Priorities and Application Stack Size*, page 4-105, for stack size restrictions. You cannot sort software interrupts within a single priority level.

The Property window for an SWI object shows its numeric priority level (from 0 to 14; 14 is the highest level). You can also set the priority by selecting the priority level from the menu in the Property window as shown in Figure 4–6.

Figure 4–6 SWI Properties Dialog Box

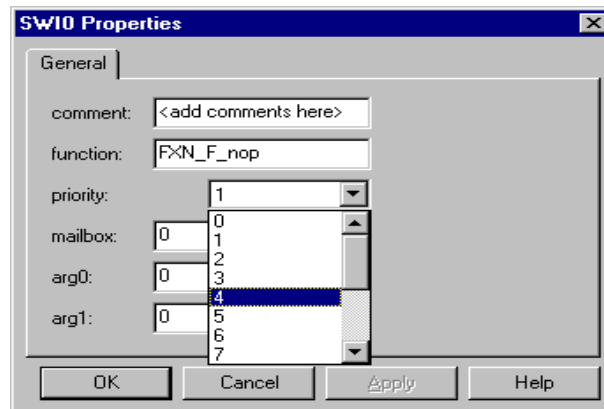

4.3.3 Software Interrupt Priorities and Application Stack Size

All threads in DSP/BIOS, excluding tasks, are executed using the same system stack.

The system stack stores the register context when a software interrupt preempts another thread. To allow the maximum number of preemptions that can occur at run time, the required stack size grows each time you add a software interrupt priority level. Thus, giving software interrupts the same priority level is more efficient in terms of stack size than giving each software interrupt a separate priority.

The default system stack size for the MEM module is 256 words. You can change the sizes in the configuration. The estimated sizes required are shown in the status bar at the top of the Configuration Tool.

You can have up to 15 software interrupt priority levels, but each level requires a larger system stack. If you see a pop-up message that says “the system stack size is too small to support a new software interrupt priority level,” increase the Application Stack Size property of the Memory Section Manager.

Creating the first PRD object creates a new SWI object called PRD_swi (see Section 4.10, *Periodic Function Manager (PRD) and the System Clock*, page 4-140, for more information on PRD). If no SWI objects have been created before the first PRD object is added, adding PRD_swi uses the first priority level, producing a corresponding increase in the required system stack.

If the TSK Manager has been enabled, the TSK scheduler (run by an SWI object named KNL_swi) reserves the lowest SWI priority level. No other SWI objects can have that priority.

4.3.4 Execution of Software Interrupts

Software interrupts can be scheduled for execution with a call to SWI_andn, SWI_dec, SWI_inc, SWI_or, and SWI_post. These calls can be used virtually anywhere in the program—interrupt service routines, periodic functions, idle functions, or other software interrupt functions.

When an SWI object is posted, the SWI Manager adds it to a list of posted software interrupts that are pending execution. Then the SWI Manager checks whether software interrupts are currently enabled. If they are not, as is the case inside an HWI function, the SWI Manager returns control to the current thread.

If software interrupts are enabled, the SWI Manager checks the priority of the posted SWI object against the priority of the thread that is currently running. If the thread currently running is the background idle loop or a lower priority SWI, the SWI Manager removes the SWI from the list of posted SWI objects and switches the CPU control from the current thread to start execution of the posted SWI function.

If the thread currently running is an SWI of the same or higher priority, the SWI Manager returns control to the current thread, and the posted SWI function runs after all other SWIs of higher priority or the same priority that were previously posted finish execution.

Note: Two things to remember about SWI:

When an SWI starts executing it must run to completion without blocking.

When called from within an HWI, the code sequence calling any of the SWI functions which can trigger or post a software interrupt must be either wrapped within an HWI_enter/HWI_exit pair or invoked by the HWI dispatcher.

SWI functions can be preempted by threads of higher priority (such as an HWI or an SWI of higher priority). However, SWI functions cannot block. You cannot suspend a software interrupt while it waits for something—like a device—to be ready.

If an SWI is posted multiple times before the SWI Manager has removed it from the posted SWI list, its SWI function executes only once, much like an HWI is executed only once if the hardware interrupt is triggered multiple times before the CPU clears the corresponding interrupt flag bit in the interrupt flag register. (See Section 4.3.5, *Using an SWI Object's Mailbox*, page 4-106, for more information on how to handle SWIs that are posted multiple times before they are scheduled for execution.)

Applications should not make any assumptions about the order in which SWI handlers of equal priority are called. However, an SWI handler can safely post itself (or be posted by another interrupt). If more than one is pending, all SWI handlers are called before any tasks run.

4.3.5 Using an SWI Object's Mailbox

Each SWI object has a 32-bit mailbox, which is used either to determine whether to post the software interrupt or as values that can be evaluated within the SWI function.

SWI_post, SWI_or, and SWI_inc post an SWI object unconditionally:

- SWI_post does not modify the value of the SWI object mailbox when it is used to post a software interrupt.
- SWI_or sets the bits in the mailbox determined by a mask that is passed as a parameter, and then posts the software interrupt.
- SWI_inc increases the SWI's mailbox value by one before posting the SWI object.

SWI_andn and SWI_dec post the SWI object only if the value of its mailbox becomes 0:

- SWI_andn clears the bits in the mailbox determined by a mask passed as a parameter.
- SWI_dec decreases the value of the mailbox by one.

Table 4–4 summarizes the differences between these functions.

Table 4–4. SWI Object Function Differences

Action	Treats Mailbox as Bitmask	Treats Mailbox as Counter	Does not Modify Mailbox
Always post	SWI_or	SWI_inc	SWI_post
Post if it becomes zero	SWI_andn	SWI_dec	—

The SWI mailbox allows you to have tighter control over the conditions that should cause an SWI function to be posted, or the number of times the SWI function should be executed once the software interrupt is posted and scheduled for execution.

To access the value of its mailbox, an SWI function can call `SWI_getmbox`. `SWI_getmbox` can be called only from the SWI's object function. The value returned by `SWI_getmbox` is the value of the mailbox before the SWI object was removed from the posted SWI queue and the SWI function was scheduled for execution.

When the SWI Manager removes a pending SWI object from the posted object's queue, its mailbox is reset to its initial value. The initial value of the mailbox should be set in the `.tcf` configuration file. If while the SWI function is executing it is posted again, its mailbox is updated accordingly. However, this does not affect the value returned by `SWI_getmbox` while the SWI functions execute. That is, the mailbox value that `SWI_getmbox` returns is the latched mailbox value when the software interrupt was removed from the list of pending SWIs. The SWI's mailbox however, is immediately reset after the SWI is removed from the list of pending SWIs and scheduled for execution. This gives the application the ability to keep updating the value of the SWI mailbox if a new posting occurs, even if the SWI function has not finished its execution.

For example, if an SWI object is posted multiple times before it is removed from the queue of posted SWIs, the SWI Manager schedules its function to execute only once. However, if an SWI function must always run multiple times when the SWI object is posted multiple times, `SWI_inc` should be used to post the SWI as shown in Figure 4–7.

When an SWI has been posted using `SWI_inc`, once the SWI Manager calls the corresponding SWI function for execution, the SWI function can access the SWI object mailbox to know how many times it was posted before it was scheduled to run, and proceed to execute the same routine as many times as the value of the mailbox.

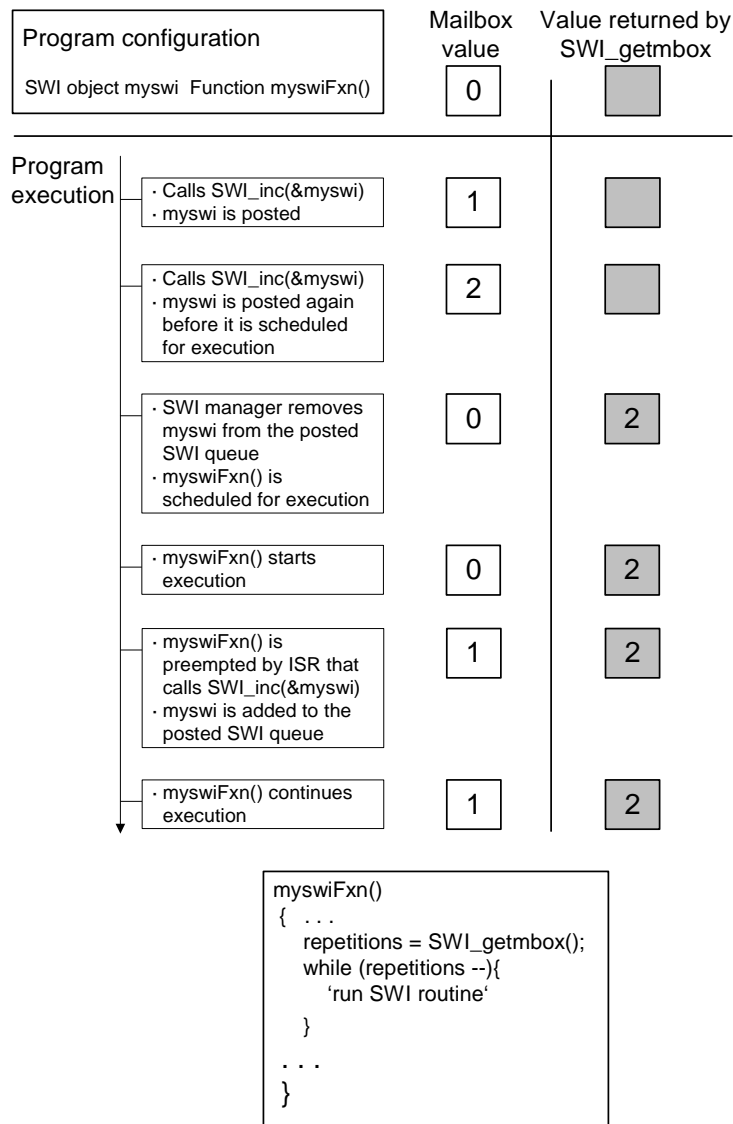
Figure 4–7 Using SWI_inc to Post an SWI

If more than one event must always happen for a given software interrupt to be triggered, `SWI_andn` should be used to post the corresponding SWI object as shown in Figure 4–8. For example, if a software interrupt must wait for input data from two different devices before it can proceed, its mailbox should have two set bits when the SWI object was configured. When both routines that provide input data have completed their tasks, they should both call `SWI_andn` with complementary bitmasks that clear each of the bits set in the SWI mailbox default value. Hence, the software interrupt is posted only when data from both processes is ready.

Figure 4–8 Using SWI_andn to Post an SWI

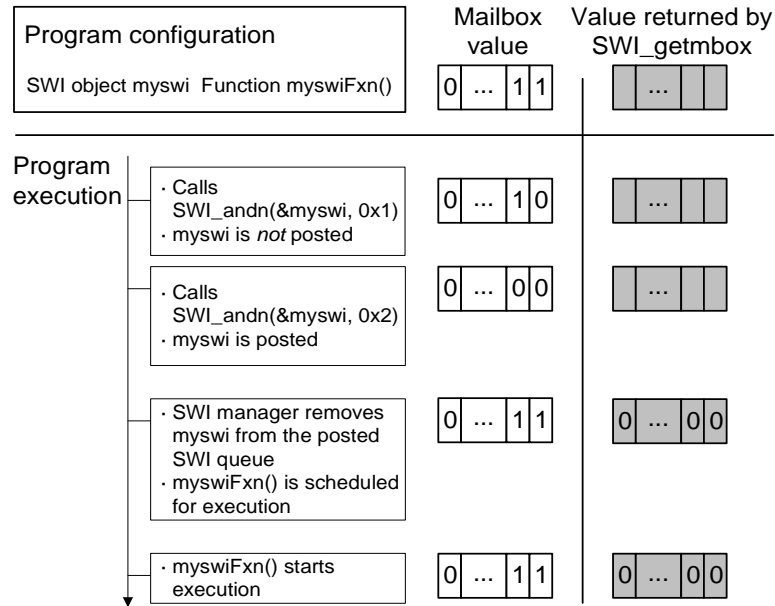

In some situations the SWI function can call different routines depending on the event that posted it. In that case the program can use SWI_or to post the SWI object unconditionally when an event happens. This is shown in Figure 4–9. The value of the bitmask used by SWI_or encodes the event type that triggered the post operation, and can be used by the SWI function as a flag that identifies the event and serves to choose the routine to execute.

Figure 4–9 Using SWI_or to Post an SWI.

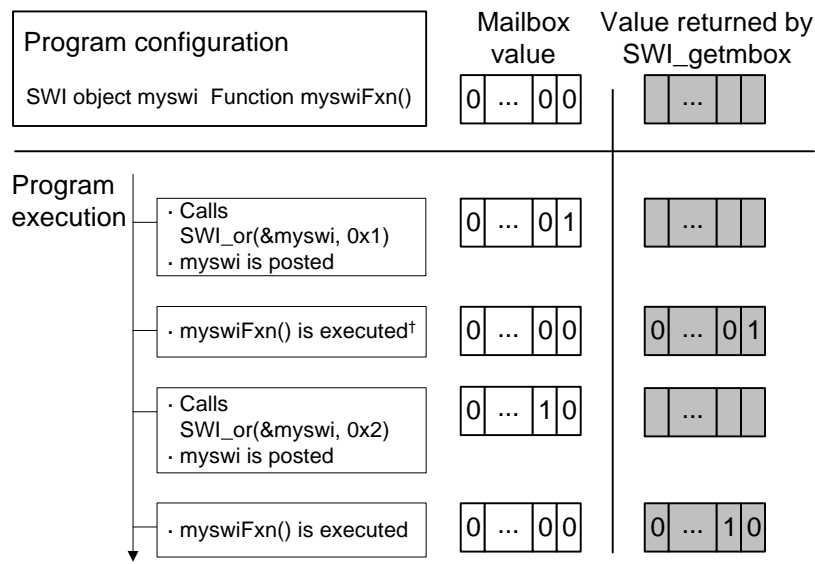

If the program execution requires that multiple occurrences of the same event must take place before an SWI is posted, SWI_dec should be used to post the SWI as shown in Figure 4–10. By configuring the SWI mailbox to be equal to the number of occurrences of the event before the SWI should be posted and calling SWI_dec every time the event occurs, the SWI is posted only after its mailbox reaches 0; that is, after the event has occurred a number of times equal to the mailbox value.

Figure 4–10 Using SWI_dec to Post an SWI

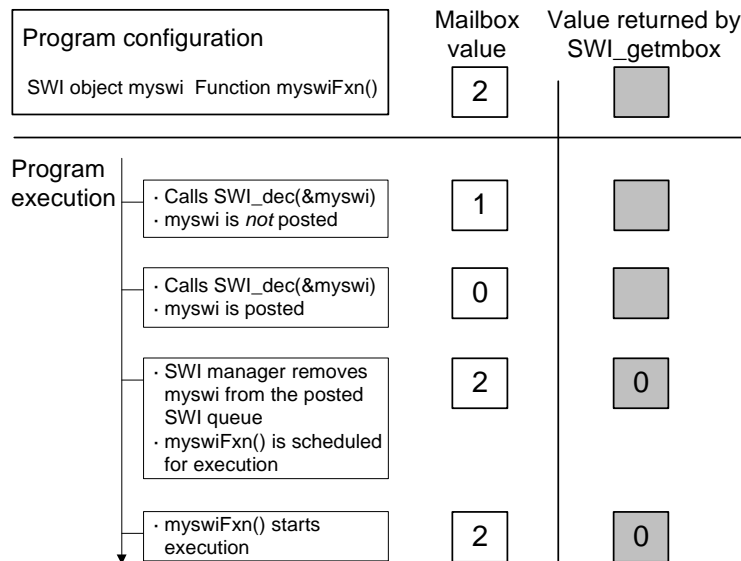

4.3.6 Benefits and Tradeoffs

There are two main benefits to using software interrupts instead of hardware interrupts.

First, SWI handlers can execute with all hardware interrupts enabled. To understand this advantage, recall that a typical HWI modifies a data structure that is also accessed by tasks. Tasks therefore need to disable hardware interrupts when they wish to access these data structures in a mutually exclusive way. Obviously, disabling hardware interrupts always has the potential to degrade the performance of a real-time system.

Conversely, if a shared data structure is modified by an SWI handler instead of an HWI, mutual exclusion can be achieved by disabling software interrupts while the task accesses the shared data structure (SWI_disable and SWI_enable are described later in this chapter). Thus, there is no effect on the ability of the system to respond to events in real-time using hardware interrupts.

It often makes sense to break long ISRs into two pieces. The HWI takes care of the extremely time-critical operation and defers the less critical processing to an SWI handler.

The second advantage is that an SWI handler can call some functions that cannot be called from an HWI, because an SWI handler is guaranteed not to run while DSP/BIOS is updating internal data structures. This is an important feature of DSP/BIOS and you should become familiar with the table, *Functions Callable by Tasks, SWI Handlers, or Hardware ISRs* in the *TMS320 DSP/BIOS API Reference Guide* for your platform that lists DSP/BIOS functions and the threads from which each function can be called.



Note: SWI handlers can call any DSP/BIOS function that does not block. For example, SEM_pend can make a task block, so SWI handlers cannot call SEM_pend or any function that calls SEM_pend (for example, MEM_alloc, TSK_sleep).

On the other hand, an SWI handler must complete before any blocked task is allowed to run. There might be situations where the use of a task might fit better with the overall system design, in spite of any additional overhead involved.

4.3.7 Saving Registers During Software Interrupt Preemption

When a software interrupt preempts another thread, DSP/BIOS preserves the context of the preempted thread by automatically saving all of the CPU registers shown in Table 4–5 onto the system stack.

Table 4–5. CPU Registers Saved During Software Interrupt

C55x Platform 			C6000 Platform 		C28x Platform 	
ac0	rea1	t0	a0–a9	b16- b31	al	xt
ac1	rptc	t1	a16- a31	(C64x only)	ah	ph
ac2	rsa0	trn1	(C64x only)	(C64x only)	xar0	pl
ac3	rsa1	xar1	b0–99	CSR	xar4	dp
brc1	st0	xar2		AMR	xar5	
brs1	st1	xar3			xar6	
csr	st2	xar4			xar7	
rea0	st3					

All registers listed in Table 4–5 are saved when a software interrupt preempts another thread. It is not necessary for a SWI handler written in either C or assembly to save any registers. However, if the SWI handler is written in assembly, it is safest to follow the register conventions and save the "save on entry" registers, since future DSP/BIOS implementations may not save these registers. These "save on entry" registers are a10 through a15 and b10 through b15 for C6000. (See the optimizing compiler user's guide for your platform for more details on C register conventions.)



An SWI function that modifies the IER register should save it and then restore it before it returns. If the SWI function fails to do this, the change becomes permanent and any other thread that starts to run or that the program returns to afterwards can inherit the modification to the IER.

The context is not saved automatically within an HWI function. You must use the HWI_enter and HWI_exit macros or the HWI dispatcher to preserve the interrupted context when an HWI function is triggered.

4.3.8 Synchronizing SWI Handlers

Within an idle loop function, task, or software interrupt function, you can temporarily prevent preemption by a higher-priority software interrupt by calling SWI_disable, which disables all SWI preemption. To reenables SWI preemption, call SWI_enable.

Software interrupts are enabled or disabled as a group. An individual software interrupt cannot be enabled or disabled on its own.

When DSP/BIOS finishes initialization and before the first task is called, software interrupts have been enabled. If an application wishes to disable software interrupts, it calls `SWI_disable` as follows:

```
key = SWI_disable();
```

The corresponding enable function is `SWI_enable`.

```
SWI_enable(key);
```

`key` is a value used by the SWI module to determine if `SWI_disable` has been called more than once. This allows nesting of `SWI_disable` / `SWI_enable` calls, since only the outermost `SWI_enable` call actually enables software interrupts. In other words, a task can disable and enable software interrupts without having to determine if `SWI_disable` has already been called elsewhere.

When software interrupts are disabled, a posted software interrupt does not run at that time. The interrupt is “latched” in software and runs when software interrupts are enabled and it is the highest-priority thread that is read to run.

Note: An important side effect of `SWI_disable` is that task preemption is also disabled. This is because DSP/BIOS uses software interrupts internally to manage semaphores and clock ticks.

To delete a dynamically created software interrupt, use `SWI_delete`.

The memory associated with `swi` is freed. `SWI_delete` can only be called from the task level.

4.4 Tasks

DSP/BIOS task objects are threads that are managed by the TSK module. Tasks have higher priority than the idle loop and lower priority than hardware and software interrupts.

The TSK module dynamically schedules and preempts tasks based on the task’s priority level and the task’s current execution state. This ensures that the processor is always given to the highest priority thread that is ready to run. There are 15 priority levels available for tasks. The lowest priority level (0) is reserved for running the idle loop.

The TSK module provides a set of functions that manipulate task objects. They access TSK object through handles of type `TSK_Handle`.

The kernel maintains a copy of the processor registers for each task object. Each task has its own run-time stack for storing local variables as well as for further nesting of function calls.

Stack size can be specified separately for each TSK object. Each stack must be large enough to handle normal subroutine calls as well as a single task preemption context. A task preemption context is the context that gets saved when one task preempts another as a result of an interrupt thread readying a higher priority task. If the task blocks, only those registers that a C function must save are saved to the task stack. To find the correct stack size, you can make the stack size large and then use Code Composer Studio software to find the stack size actually used.

All tasks executing within a single program share a common set of global variables, accessed according to the standard rules of scope defined for C functions.

4.4.1 Creating Tasks

You can create TSK objects either dynamically (with a call to `TSK_create`) or statically (in the configuration). Tasks that you create dynamically can also be deleted during program execution.

4.4.1.1 Creating and Deleting Tasks Dynamically

You can spawn DSP/BIOS tasks by calling the function `TSK_create`, whose parameters include the address of a C function in which the new task begins its execution. The value returned by `TSK_create` is a handle of type `TSK_Handle`, which you can then pass as an argument to other TSK functions.

```
TSK_Handle TSK_create(fxn, attrs, [arg,] ...)
    Fxn      fxn;
    TSK_Attrs *attrs
    Arg      arg
```

A task becomes active when it is created and preempts the currently running task if it has a higher priority.

The memory used by TSK objects and stacks can be reclaimed by calling `TSK_delete`. `TSK_delete` removes the task from all internal queues and frees the task object and stack by calling `MEM_free`.

Any semaphores, mailboxes, or other resources held by the task are *not* released. Deleting a task that holds such resources is often an application design error, although not necessarily so. In most cases, such resources should be released prior to deleting the task.

```
Void TSK_delete(task)
    TSK_Handle  task;
```

Note: Catastrophic failure can occur if you delete a task that owns resources that are needed by other tasks in the system. See *TSK_delete*, in the *TMS320 DSP/BIOS API Reference Guide* for your platform for details.

4.4.1.2 Creating Tasks Statically

You can also create tasks statically using `Tconf`. The configuration allows you to set a number of properties for each task and for the TSK Manager itself. For a complete description of all TSK properties, see *TSK Module* in the *TMS320 DSP/BIOS API Reference Guide* for your platform.

While it is running, a task that was created statically behaves exactly the same as a task created with `TSK_create`. You cannot use the `TSK_delete` function to delete statically-created tasks. See Section 2.6, *Creating DSP/BIOS Objects Dynamically*, page 2-37, for a discussion of the benefits of creating objects statically.

The default configuration template defines the `TSK_idle` task which must have the lowest priority. It runs the functions defined for the IDL objects when no higher-priority task or interrupt is ready.



Note: DSP/BIOS splits the specified stack space equally between user (data) stack memory and system stack memory.

When you configure tasks to have equal priority, they are scheduled in the order in which they are created in the configuration script. Tasks can have up to 16 priority levels. The highest level is 15 and the lowest is 0. The priority level of 0 is reserved for the system idle task. You cannot sort tasks within a single priority level by setting the order property.

If you want a task to be initially suspended, set its priority to -1. Such tasks are not scheduled to run until their priority is raised at run-time.

4.4.2 Task Execution States and Scheduling

Each TSK task object is always in one of four possible states of execution:

1. **Running**, which means the task is the one actually executing on the system's processor;
2. **Ready**, which means the task is scheduled for execution subject to processor availability;
3. **Blocked**, which means the task cannot execute until a particular event occurs within the system; or
4. **Terminated**, which means the task is "terminated" and does not execute again.

Tasks are scheduled for execution according to a priority level assigned to the application. There can be no more than one running task. As a rule, no ready task has a priority level greater than that of the currently running task, since TSK preempts the running task in favor of the higher-priority ready task. Unlike many time-sharing operating systems that give each task its "fair share" of the processor, DSP/BIOS *immediately* preempts the current task whenever a task of higher priority becomes ready to run.

The maximum priority level is TSK_MAXPRI (15); the minimum priority is TSK_MINPRI (1). If the priority is less than 0, the task is barred from further execution until its priority is raised at a later time by another task. If the priority equals TSK_MAXPRI, the task execution effectively locks out all other program activity except for the handling of hardware interrupts and software interrupts.

During the course of a program, each task's mode of execution can change for a number of reasons. Figure 4–11 shows how execution modes change.

Figure 4–11 Execution Mode Variations

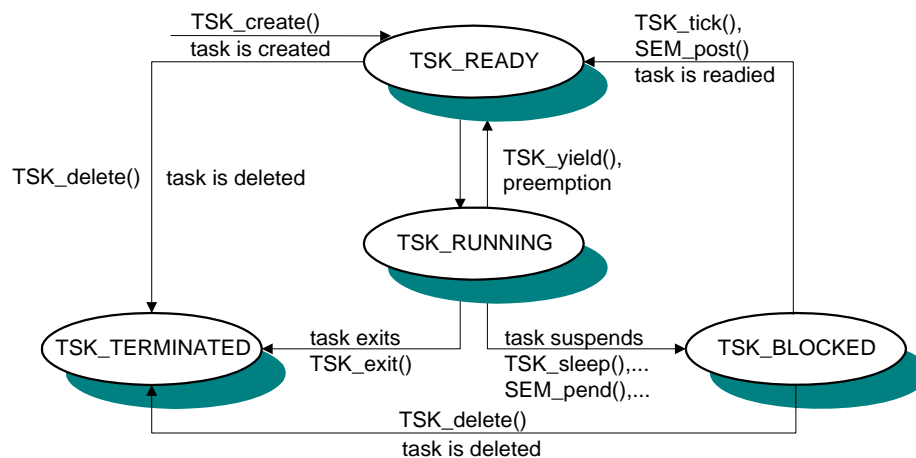

Functions in the TSK, SEM, and SIO modules alter the execution state of task objects: blocking or terminating the currently running task, readying a previously suspended task, re-scheduling the current task, and so forth.

There is *one* task whose execution mode is TSK_RUNNING. If all program tasks are blocked and no hardware or software interrupt is running, TSK executes the TSK_idle task, whose priority is lower than all other tasks in the system. When a task is preempted by a software or hardware interrupt, the task execution mode returned for that task by TSK_stat is still TSK_RUNNING because the task will run when the preemption ends.

Note: Do not make blocking calls, such as SEM_pend or TSK_sleep, from within an IDL function. Doing so prevents DSP/BIOS analysis tools from gathering run-time information.

When the TSK_RUNNING task transitions to any of the other three states, control switches to the highest-priority task that is ready to run (that is, whose mode is TSK_READY). A TSK_RUNNING task transitions to one of the other modes in the following ways:

- The running task becomes TSK_TERMINATED by calling TSK_exit, which is automatically called if and when a task returns from its top-level function. After all tasks have returned, the TSK Manager terminates program execution by calling SYS_exit with a status code of 0.
- The running task becomes TSK_BLOCKED when it calls a function (for example, SEM_pend or TSK_sleep) that causes the current task to suspend its execution; tasks can move into this state when they are performing certain I/O operations, awaiting availability of some shared resource, or idling.
- The running task becomes TSK_READY and is preempted whenever some other, higher-priority task becomes ready to run. TSK_setpri can cause this type of transition if the priority of the current task is no longer the highest in the system. A task can also use TSK_yield to yield to other tasks with the same priority. A task that yields becomes ready to run.

A task that is currently TSK_BLOCKED transitions to the ready state in response to a particular event: completion of an I/O operation, availability of a shared resource, the elapse of a specified period of time, and so forth. By virtue of becoming TSK_READY, this task is scheduled for execution according to its priority level; and, of course, this task immediately transitions to the running state if its priority is higher than the currently executing task. TSK schedules tasks of equal priority on a first-come, first-served basis.

4.4.3 Testing for Stack Overflow

When a task uses more memory than its stack has been allocated, it can write into an area of memory used by another task or data. This results in unpredictable and potentially fatal consequences. Therefore, a means of checking for stack overflow is useful.

Two functions, TSK_checkstacks, and TSK_stat, can be used to watch stack size. The structure returned by TSK_stat contains both the size of its stack and the maximum number of MADUs ever used on its stack, so this code segment could be used to warn of a nearly full stack:

```
TSK_stat statbuf;                /* declare buffer */

TSK_stat(TSK_self(), &statbuf); /* call func to get status */
if (statbuf.used > (statbuf.attrs.stacksize * 9 / 10)) {
    LOG_printf(&trace, "Over 90% of task's stack is in use.\n")
}
}
```

See the *TSK_stat* and *TSK_checkstacks* sections in the *TMS320 DSP/BIOS API Reference Guide* for your platform, for a description and examples of their use.

4.4.4 Task Hooks

An application may specify functions to be called for various task-related events. Such functions are called hook functions. Hook functions can be called for program initialization, task creation (TSK_create), task deletion (TSK_delete), task exits (TSK_exit), task readying, and task context switches (TSK_sleep, SEM_pend, etc.). Such functions can be used to extend a task's context beyond the basic processor register set.

A single set of hook functions can be specified for the TSK module manager. To create additional sets of hook functions, use the HOOK module. For example, an application that integrates third-party software may need to perform both its own hook functions and the hook functions required by the third-party software. In addition, each HOOK object can maintain a private data environment for each task.

When you configure the initial HOOK object, any TSK module hook functions you have specified are automatically placed in a HOOK object called HOOK_KNL. To set any properties of this object other than the Initialization function, use the TSK module properties. To set the Initialization function property of the HOOK_KNL object, use the HOOK object properties. If you configure only a single set of hook functions using the TSK module, the HOOK module is not used.

For details about hook functions, see the TSK Module and HOOK Module topics in the *TMS320 DSP/BIOS API Reference Guide* for your platform.

4.4.5 Task Hooks for Extra Context

Consider, for example, a system that has special hardware registers (say, for extended addressing) that need to be preserved on a per task basis. In Example 4-6 the function doCreate is used to allocate a buffer to maintain these registers on a per task basis, doDelete is used to free this buffer, and doSwitch is used to save and restore these registers.

If task objects are created statically, the Switch function should *not* assume (as Example 4-6 does) that a task's environment is always set by the Create function.

Example 4-6 Creating a Task Object

```

#define CONTEXTSIZE    `size of additional context`

Void doCreate(task)
    TSK_Handle        task;
{
    Ptr                context;

    context = MEM_alloc(0, CONTEXTSIZE, 0);
    TSK_setenv(task, context);    /* set task environment */
}

Void doDelete(task)
    TSK_Handle        task;
{
    Ptr                context;

    context = TSK_getenv(task);    /* get register buffer */
    MEM_free(0, context, CONTEXTSIZE);
}

Void doSwitch(from, to)
    TSK_Handle        from;
    TSK_Handle        to;
{
    Ptr                context;

    static Int first = TRUE;
    if (first) {
        first = FALSE;
        return;
    }

    context = TSK_getenv(from);    /* get register buffer */
    *context = `hardware registers`; /* save registers */

    context = TSK_getenv(to);    /* get register buffer /
    `hardware registers` = *context; /* restore registers */
}

Void doExit(Void)
{
    TSK_Handle        usrHandle;
    /* get task handle, if needed */
    usrHandle = TSK_self();

    `perform user-defined exit steps`
}

```



Non-pointer type function arguments to LOG_printf need explicit type casting to (Arg) as shown in the following code example:



```
LOG_printf(&trace, "Task %d Done", (Arg) id);
```

4.4.6 Task Yielding for Time-Slice Scheduling

Example 4-7 demonstrates an implementation of a time-slicing scheduling model that can be managed by a user. This model is preemptive and does not require any cooperation (which is, code) by the tasks. The tasks are programmed as if they were the only thread running. Although DSP/BIOS tasks of differing priorities can exist in any given application, the time-slicing model only applies to tasks of equal priority.

In this example, the prd0 PRD object is configured to run a simple function that calls the TSK_yield() function every one millisecond. The prd1 PRD object is configured to run a simple function that calls the SEM_post(&sem) function every 16 milliseconds.

Figure 4-12 shows the trace resulting from Example 4-7,.

Example 4-7 Time-Slice Scheduling

```

/*
 * ===== slice.c =====
 * This example utilizes time-slice scheduling among three
 * tasks of equal priority. A fourth task of higher
 * priority periodically preempts execution.
 *
 * A PRD object drives the time-slice scheduling. Every
 * millisecond, the PRD object calls TSK_yield()
 * which forces the current task to relinquish access to
 * to the CPU. The time slicing could also be driven by
 * a CLK object (as long as the time slice was the same interval
 * as the clock interrupt), or by another hardware
 * interrupt.
 *
 * The time-slice scheduling is best viewed in the Execution
 * Graph with SWI logging and PRD logging turned off.
 *
 * Because a task is always ready to run, this program
 * does not spend time in the idle loop. Calls to IDL_run()
 * are added to force the update of the Real-Time Analysis
 * tools. Calls to IDL_run() are within a TSK_disable(),
 * TSK_enable() block because the call to IDL_run()
 * is not reentrant.
 */

#include <std.h>

#include <clk.h>
#include <idl.h>
#include <log.h>
#include <sem.h>
#include <swi.h>
#include <tsk.h>

#include "slicecfg.h"

Void task(Arg id_arg);
Void hi_pri_task(Arg id_arg);
Uns counts_per_us; /* hardware timer counts per microsecond */

```

Example 4.7 Time-Slice Scheduling (continued)

```

/* ===== main ===== */
Void main()
{
    LOG_printf(&trace, "Slice example started!");
    counts_per_us = CLK_countspsms() / 1000;
}

/* ===== task ===== */
Void task(Arg id_arg)
{
    Int id = ArgToInt(id_arg);
    LgUns time;
    LgUns prevtime;

    /*
     * The while loop below simulates the work load of
     * the time sharing tasks
     */
    while (1) {
        time = CLK_gethtime() / counts_per_us;

        /* print time only every 200 usec */
        if (time >= prevtime + 200) {
            prevtime = time;
            LOG_printf(&trace, "Task %d: time is(us) 0x%x",
                id, (Int)time);
        }

        /* check for rollover */
        if (prevtime > time) {
            prevtime = time;
        }

        /*
         * pass through idle loop to pump data to the Real-Time
         * Analysis tools
         */
        TSK_disable();
        IDL_run();
        TSK_enable();
    }
}

/* ===== hi_pri_task ===== */
Void hi_pri_task(Arg id_arg)
{
    Int id = ArgToInt(id_arg);

    while (1) {
        LOG_printf(&trace, "Task %d here", id);

        SEM_pend(&sem, SYS_FOREVER);
    }
}

```

Figure 4–12 Trace from Example 4-7

```

Slice example started!
Task 4 here
Task 1: time is(us) 0xe7
Task 1: time is(us) 0x1c2
Task 1: time is(us) 0x2c9
Task 1: time is(us) 0x3d0
Task 2: time is(us) 0x4cb
Task 2: time is(us) 0x594
Task 2: time is(us) 0x65d
Task 2: time is(us) 0x726
Task 3: time is(us) 0x89b
Task 3: time is(us) 0x967
Task 3: time is(us) 0xa32
Task 3: time is(us) 0xaf6
Task 1: time is(us) 0xc72
Task 1: time is(us) 0xd3d

```

4.5 The Idle Loop

The idle loop is the background thread of DSP/BIOS, which runs continuously when no hardware interrupt service routines, software interrupt, or tasks are running. Any other thread can preempt the idle loop at any point.

The IDL Manager allows you to insert functions that execute within the idle loop. The idle loop runs the IDL functions you configured. IDL_loop calls the functions associated with each one of the IDL objects one at a time, and then starts over again in a continuous loop. The functions are called in the same order in which they were created. Therefore, an IDL function must run to completion before the next IDL function can start running. When the last idle function has completed, the idle loop starts the first IDL function again. Idle loop functions are often used to poll non-real-time devices that do not (or cannot) generate interrupts, monitor system status, or perform other background activities.

The idle loop is the thread with lowest priority in a DSP/BIOS application. The idle loop functions run only when no other hardware interrupts, software interrupts, or tasks need to run. Communication between the target and the DSP/BIOS analysis tools is performed within the background idle loop. This ensures that the DSP/BIOS analysis tools do not interfere with the program's processing. If the target CPU is too busy to perform background processes, the DSP/BIOS analysis tools stop receiving information from the target until the CPU is available.

By default, the idle loop runs the functions for these IDL objects:

- **LNK_dataPump** manages the transfer of real-time analysis data (for example, LOG and STS data), and HST channel data between the target DSP and the host. This is handled using RTDX.

On the C55x and C6000 platforms, the host PC triggers an interrupt to transfer data to and from the target. This interrupt has a higher priority than SWI, TSK, and IDL functions. The actual HWI function runs in a very short time. Within the idle loop, the LNK_dataPump function does the more time-consuming work of preparing the RTDX buffers and performing the RTDX calls. Only the actual data transfer is done at high priority. This data transfer can have a small effect on real-time behavior, particularly if a large amount of LOG data must be transferred.

- **RTA_dispatcher** is a real-time analysis server on the target that accepts commands from DSP/BIOS analysis tools, gathers instrumentation information from the target, and uploads it at run time. RTA_dispatcher sits at the end of two dedicated HST channels; its commands/responses are routed from/to the host via LNK_dataPump.

- **IDL_cpuLoad** uses an STS object (IDL_busyObj) to calculate the target load. The contents of this object are uploaded to the DSP/BIOS analysis tools through RTA_dispatcher to display the CPU load.
- **PWRM_idleDomains** calls a function to idle various DSP clock domains within the DSP/BIOS idle loop. Various clock domains to idle can be selected in the PWRM module configuration. When a HWI, SWI, or TSK thread is ready to run, the idled clock domains are restored to their previous configuration.

4.6 Power Management



The DSP/BIOS Power Manager, PWRM, is a DSP/BIOS module that lets you reduce the power consumption of your application. The PWRM module is currently available for the 'C5509A EVM and the C6748 EVM. Partial support for other 'C55x devices is also available. See the DSP/BIOS release notes to determine which features are supported on different devices.

The PWRM module provides the following capabilities:

- **Resource Tracking.** You can make runtime PWRM API calls to inform the Power Manager of the specific resources (for example, clock domains, peripherals, and clock pins) that your application is dependent upon. With this knowledge of required resources, PWRM can aggressively idle resources that have no declared dependencies. See Section 4.6.1.
- **Scaling Voltage and Frequency.** You can dynamically change the operating voltage and frequency of the CPU. This is called V/F scaling. Since power usage is linearly proportional to the frequency and quadratically proportional to the voltage, using the PWRM module can result in significant power savings. See Section 4.6.2.
- **Using Sleep Modes.** You can activate sleep modes to save power during inactivity. See Section 4.6.3.
- **Coordinating Sleep and Scaling.** You can coordinate sleep modes and V/F scaling using registration and notification mechanisms provided by the PWRM module. See Section 4.6.4.

The 'C55x PWRM module provides these additional capabilities:

- **Idling Clock Domains.** You can idle specific clock domains to reduce active power consumption. See Section 4.6.5.
- **Saving Power at Boot Time.** You can specify a power-saving function to be called automatically at boot time. This function can idle power-using peripherals as desired. See Section 4.6.6.
- **DSP Device Initialization.** You can have PWRM perform device-specific power saving operations at boot time. For example, PWRM can automatically idle clock domains that aren't usually needed by default (for example, DMA), or it can idle-enable certain peripherals so that they sit in their lowest power state until they are needed. See Section 4.6.7.

Note: It is important to note that the PWRM module does not ensure that the application can meet its scheduling requirements. Meeting such requirements is the responsibility of the application and the developer.

4.6.1 Resource Tracking



A typical DSP/BIOS application uses a set of peripherals—timers, serial ports, etc.—to accomplish its purpose. Typically device drivers manage low-level peripheral accesses, but sometimes applications access peripherals directly. In both these scenarios, the DSP/BIOS kernel itself does not "know" which peripherals are being used. This information is distributed across the application code and drivers, and is not stored within the kernel. As a consequence, the DSP/BIOS Power Manager does not know what resources are actually required by an application at any given instance, so it cannot aggressively idle resources without possibly "breaking" the application.

On some devices PWRM provides a "resource tracking" feature to allow more aggressive power management. Applications, drivers, and DSP/BIOS modules can call PWRM APIs to declare dependencies upon specific resources as those resources are needed. When resources are no longer needed—for example, when a port is closed or when there is no work for an audio driver to do—a companion PWRM API call can be made to release the resource dependency. PWRM counts the "set" and "release" calls, and automatically turns ON a resource when the first "set" operation occurs, and automatically turns OFF that resource when the last "release" call occurs.

Resource tracking can be used in conjunction with PWRM's device initialization feature (available on some 'C55x devices):

1. At boot time PWRM initializes resources to be powered down.
2. When the application needs to use a resource (for example, DMA) it calls `PWRM_setDependency` to register the dependency. PWRM then automatically powers up the resource (for example, by un-idling the DMA clock domain).
3. When the resource is no longer needed, the application calls `PWRM_releaseDependency`. If there are no other dependencies still registered on that resource, PWRM automatically powers it down (for example, by idling the DMA domain).

You may have legacy code that cannot be easily modified to add PWRM resource tracking calls. For example, a driver may only be available in binary form. In such situations, you can add calls to `PWRM_setDependency` at boot time to declare dependencies in legacy code.

The resources tracked by PWRM will vary from device to device, and are described in the corresponding DSP/BIOS release notes.

4.6.2 Scaling Voltage and Frequency



Active power dissipation of a CMOS-based DSP is linearly proportional to the clock rate (frequency), and quadratically proportional to the operating voltage. Additionally, the operating voltage determines the maximum clock rate available.

Therefore, if an application can reduce the CPU clock rate and still meet its processing deadlines, it can produce a linearly proportional savings in power dissipation. However, reducing the CPU clock rate also proportionally extends the execution time, so the application must be carefully analyzed to make sure it can still meet its real-time requirements.

If the clock frequency can be reduced and the new frequency is compatible with a lower operating voltage supported by the DSP, then potentially significant additional savings can be also be made by reducing the voltage, due to the quadratic relationship.

The PWRM module allows an application to call `PWRM_changeSetpoint` to change the operating voltage and frequency (V/F). So, for example, when an application switches to a mode with reduced processing requirements, it can step down the voltage and frequency to reduce power usage. Or, an application might accumulate "slack" time in its data-dependent processing, and then reduce V/F to absorb the slack time while running at lower power.

Applications also can learn about the V/F scaling features supported by a platform using the `PWRM_getCurrentSetpoint`, `PWRM_getNumSetpoints`, `PWRM_getSetpointInfo`, and `PWRM_getTransitionLatency` functions.

The PWRM module also supports coordination of V/F changes across the application, through a registration and notification mechanism. Additionally, clients can indicate to PWRM the V/F setpoints they support. PWRM will check the client-registered constraints before attempting to transition to the requested setpoint.

The PWRM module makes V/F scaling changes using a platform-specific Power Scaling Library (denoted PSL for 'C55x devices, and PSCL for 'C6748). These libraries are implemented only for certain platforms. For additional information about using the 'C55x Power Scaling Library, with PWRM or alone, see *Using the Power Scaling Library on the TMS320C5510* (SPRA848).

4.6.2.1 Effects on the DSP/BIOS CLK Module

On some 'C55x devices, for example the 'C5509A, the clock affected by V/F scaling (CPU) is the same clock that drives the timer used by DSP/BIOS for clock services (the CLK module). This means changing the V/F setpoint disrupts DSP/BIOS clock services. To minimize disruption, the PWRM module allows the DSP/BIOS CLK module to register for notification of V/F scaling events. When notified of a new V/F setpoint, the CLK module reprograms the timer to tick at the same rate used prior to the scaling operation.

As a result, low-resolution time (`CLK_gettime`) continues to function following frequency scaling. However, a small amount of absolute time may be lost due to the reprogramming operation. The loss occurs because the DSP/BIOS timer halts temporarily as the last step before V/F scaling occurs. As soon as possible after a scaling operation, the timer begins ticking at the same rate used before the scaling operation. During the scaling operation, time essentially "stands still" for DSP/BIOS and the application. No effort is made to catch up for time lost while the clock was stopped or while the timer was reprogrammed to tick at the same rate using the new CPU frequency. Also, absolute accuracy varies depending upon how well the new input frequency can be divided down to generate the selected tick rate.

High-resolution time (`CLK_gettime`) can be used in combination with V/F scaling with the following caveats:

- Across setpoint transitions, comparing `CLK_gettime` deltas produces an erroneous value. Between setpoint transitions, `CLK_gettime` can still be used to get high-resolution deltas.
- The rate at which the timer increments or decrements is usually different at different V/F setpoints.

4.6.3 Using Sleep Modes



PWRM allows applications to activate sleep modes, which place the DSP in a low-power state. Configuration and implementation of sleep modes vary across target platforms, and can include idling clocks, reducing operating voltage, and powering off subsystems. For example, for the 'C5509A, two sleep modes are supported: deep sleep and sleep until restart.

- **Deep sleep** allows the DSP to enter a minimum power state while waiting for an external interrupt. When the interrupt occurs, the DSP gracefully and quickly resumes processing where it left off. By default, all clock domains are idled in deep sleep, but PWRM allows you to override this and configure the specific clock domains to be idled during deep sleep.

- **Sleep until restart** is a more drastic mode. The DSP is put into a minimal power state with no intention of resuming until the DSP is rebooted.

The PWRM module also supports coordination of sleep state changes across the application, through a registration and notification mechanism. For example, a driver that controls an external codec can register to be notified when the DSP is going to deep sleep, so that it can tell the external device to go to a low power state. When the DSP wakes from deep sleep, the driver again gets notified, and sends the appropriate command to wake the codec.

The sleep modes supported by PWRM vary from device to device, and are described in the corresponding DSP/BIOS release notes.

4.6.4 **Coordinating Sleep and Scaling**



PWRM allows code that cares about power events to be registered for notification when specific power events occur. Similarly, code can be un-registered when it no longer needs notification.



For example, clients can call `PWRM_registerNotify` to register to be notified about the following types of events:

- Power events:
 - The V/F setpoint is about to change.
 - The pending V/F setpoint change has now been made.
- Sleep events:
 - The DSP is going to deep sleep.
 - The DSP has awoken from deep sleep.
 - The DSP is going to deep sleep and must be restarted to resume.

Figure 4–13 shows a sequence in which clients register and get notified of V/F power scaling events.

Figure 4–13 Power Event Notification

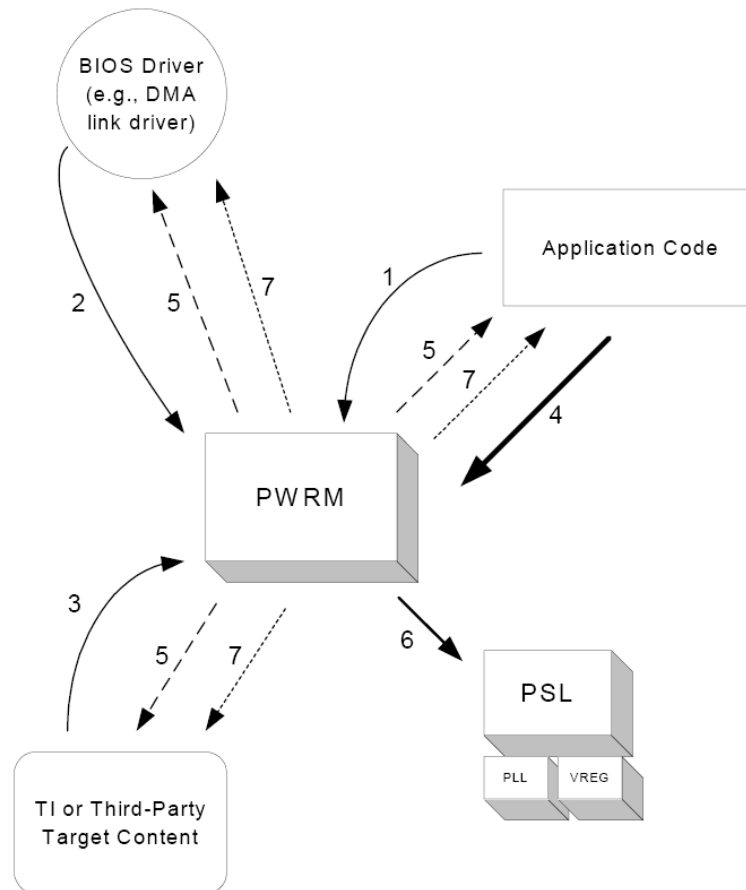

The numbered steps are as follows:

1. Application code registers to be notified of V/F setpoint changes. For example, different EMIF settings may be needed for different setpoints, so the application registers control code with the power manager (PWRM) so that it can change EMIF settings when there is a change to the setpoint.
2. A DSP/BIOS link driver using DMA for transfers to/from external memory registers to be notified of V/F setpoint changes. For example, prior to a setpoint change, the driver may need to temporarily stop DMA operations to external memory.
3. Packaged target content similarly registers for notification on setpoint changes.
4. The application decides to change the V/F setpoint, and calls `PWRM_changeSetpoint` to initiate the setpoint change. It may do this, for example, because of a change in the device's mode.
5. Before the setpoint change, PWRM validates the change request and then notifies all registered clients of the impending setpoint change. Clients are notified in the same order they registered for notification (FIFO order).
6. PWRM calls the Power Scaling Library to change the V/F setpoint.
7. After the setpoint change, PWRM notifies clients that the setpoint has been changed.

If a client's notification function can take immediate action it should do so and return `PWRM_NOTIFYDONE`. If the notification function cannot take action because it must wait, it should return `PWRM_NOTIFYNOTDONE`. Later, when that client has completed its required action (for

example, on the next interrupt from the device), it should call the `delayedCompletionFunction` indicated to it by `PWRM_registerNotify`. The PWRM module waits until all clients have returned `PWRM_NOTIFYDONE` before continuing. If a client does not signal that it is done within the timeout specified, PWRM returns `PWRM_ETIMEOUT`, indicating a system failure.

Before notifying clients of a power event, PWRM firsts disable SWI and TSK scheduling to protect against preemption while the event is being processed. The following table shows when SWI and TSK scheduling is disabled and re-enabled around event processing:

Type of Event	Disable SWI & TSK Scheduling	Re-enable Scheduling
V/F Scaling	Before notifying clients registered for pending setpoint change notification.	After changing the setpoint and notifying clients registered for completed setpoint change notification.
Sleep	Before notifying clients registered for pending sleep notification.	After wakeup and notifying clients registered for completed sleep notification.

Since SWI and TSK scheduling are disabled during PWRM notifications, clients cannot rely on SWI or TSK scheduling to finish PWRM event processing. HWIs can be used to determine and signal completion of processing of the power event. For example, to allow an in-process DMA operation to complete, the DMA ISR can still run, and then call the `delayedCompletionFunction` to signal to PWRM that the client has finished processing the event.

4.6.5 *Idling Clock Domains*



TI DSPs include an "IDLE" instruction that gates off DSP clocks to reduce active power consumption. This is the primary mechanism used to reduce power consumption at run-time. On the 'C55x, clocks are divided into the following clock domains: CPU, CACHE, DMA, EMIF, PERIPH, and CLKGEN. On some 'C55x devices, such as the 'C5509A, these domains can be idled by setting the corresponding bit in the Idle Configuration Register (ICR), and then executing the IDLE instruction.

When idling clock domains, care must be used to avoid adverse effects on application scheduling. For example, if a task decides to idle the DSP CPU until more data arrives, other tasks of equal or lower priority cannot run until the next interrupt occurs. The task has inadvertently blocked scheduling of other tasks. To avoid this situation, the DSP CPU should only be idled within the DSP/BIOS idle loop, which runs when no other threads are ready to run.

To facilitate this, the PWRM module allows you to automatically idle selected clock domains in the DSP/BIOS idle loop. The clock domains to be idled can be statically configured using PWRM module properties, and can be changed dynamically with the `PWRM_configure` function.

When PWRM is configured to idle clock domains in the IDL loop, other IDL loop processing does not run as regularly as it did previously. For example, when real-time analysis is enabled, the idle loop runs functions to compute the CPU load, to gather real-time analysis data from the DSP, and to pump data from the DSP to Code Composer Studio. When PWRM idling is enabled, the `PWRM_F_idleDomains` function is added to the list of idle loop functions. If PWRM idles the CPU domain, then each time `PWRM_F_idleDomains` runs in the idle loop, the CPU domain is suspended until the next interrupt occurs. As a result, dynamic updating of real-time analysis data in Code Composer Studio stalls or appears "choppy".

Idling clock domains within the idle loop is intended for use in deployed systems; that is, those for systems in which Code Composer Studio is not used.

The PWRM_idleClocks function provides a way to idle clock domains immediately and indefinitely. If for example, an application runs entirely from on-chip memory, it can call PWRM_idleClocks to idle the EMIF clock domain.

4.6.6 Saving Power at Boot Time



DSPs typically boot up fully powered and at their maximum clock rate. However, there are inevitably powered resources that are not needed initially, or that may never be used by a particular application.

On some 'C55x devices, such as the 'C5509A, PWRM provides a hook mechanism that allows you to specify a function to be called at boot time to turn off or idle powered resources until they are actually needed. For example, when a driver is opened later in application execution, it can power up the underlying physical device. If the driver is later closed, it can power the device back down.

Within the boot function, you can do things such as commanding external devices to go to a low power mode. Although such functionality could be implemented directly in the main routine, the boot hook mechanism allows you to closely associate power-related code with the Power Manager.

4.6.7 Device Initialization by the Power Manager



The hook mechanism described in the previous section is intended to be used by applications to power down external peripheral devices, such as an audio amplifier or a radio subsystem, at boot time. On some 'C55x devices, such as the 'C5509A, PWRM also provides a "Device Initialization" mechanism whereby PWRM traverses the DSP device at boot time, putting all appropriate on-chip peripherals and domains into their lowest power state. As the application runs, the peripherals and domains can be awoken as needed. Device initialization by PWRM is configurable as ON or OFF. The PWRM actions during device initialization are device-specific, and are described in the corresponding DSP/BIOS release notes.

4.7 Semaphores

DSP/BIOS provides a fundamental set of functions for intertask synchronization and communication based upon *semaphores*. Semaphores are often used to coordinate access to a shared resource among a set of competing tasks. The SEM module provides functions that manipulate semaphore objects accessed through handles of type SEM_Handle.

SEM objects are counting semaphores that can be used for both task synchronization and mutual exclusion. Counting semaphores keep an internal count of the number of corresponding resources available. When count is greater than 0, tasks do not block when acquiring a semaphore.

The functions SEM_create and SEM_delete are used to create and delete semaphore objects, respectively, as shown in Example 4-8. You can also create semaphore objects statically. See Section 2.6, *Creating DSP/BIOS Objects Dynamically*, page 2-37, for a discussion of the benefits of creating objects statically.

Example 4-8 Creating and Deleting a Semaphore

```
SEM_Handle SEM_create(count, attrs);
    Uns      count;
    SEM_Attrs *attrs;

Void SEM_delete(sem);
    SEM_Handle sem;
```

The semaphore count is initialized to count when it is created. In general, count is set to the number of resources that the semaphore is synchronizing.

SEM_pend waits for a semaphore. If the semaphore count is greater than 0, SEM_pend simply decrements the count and returns. Otherwise, SEM_pend waits for the semaphore to be posted by SEM_post.

Note: When called within an HWI, the code sequence calling SEM_post or SEM_ipost must be either wrapped within an HWI_enter/HWI_exit pair or invoked by the HWI dispatcher.

The timeout parameter to SEM_pend, as shown in Example 4-9, allows the task to wait until a timeout, to wait indefinitely (SYS_FOREVER), or to not wait at all (0). SEM_pend's return value is used to indicate if the semaphore was acquired successfully.

Example 4-9 Setting a Timeout with SEM_pend

```

Bool SEM_pend(sem, timeout);
SEM_Handle sem;
Uns  timeout; /* return after this many system clock ticks*/
    
```

Example 4-10 provides an example of SEM_post, which is used to signal a semaphore. If a task is waiting for the semaphore, SEM_post removes the task from the semaphore queue and puts it on the ready queue. If no tasks are waiting, SEM_post simply increments the semaphore count and returns.

Example 4-10 Signaling a Semaphore with SEM_post

```

Void SEM_post(sem);
SEM_Handle sem;
    
```

4.7.1 SEM Example

Example 4-11 provides sample code for three writer tasks which create unique messages and place them on a queue for one reader task. The writer tasks call SEM_post to indicate that another message has been enqueued. The reader task calls SEM_pend to wait for messages. SEM_pend returns only when a message is available on the queue. The reader task prints the message using the LOG_printf function.

The three writer tasks, reader task, semaphore, and queues in this example program were created statically.

Since this program employs multiple tasks, a counting semaphore is used to synchronize access to the queue. Figure 4–14 provides a view of the results from Example 4-10. Though the three writer tasks are scheduled first, the messages are read as soon as they have been enqueued because the reader's task priority is higher than that of the writer.

Example 4-11 SEM Example Using Three Writer Tasks

```

/*
 * ===== semtest.c =====
 *
 * Use a QUE queue and SEM semaphore to send messages from
 * multiple writer() tasks to a single reader() task. The
 * reader task, the three writer tasks, queues, and semaphore
 * are created statically.
 *
 * The MsgObj's are preallocated in main(), and put on the
 * free queue. The writer tasks get free message structures
 * from the free queue, write the message, and then put the
 * message structure onto the message queue.
 * This example builds on quetest.c. The major differences are:
 * - one reader() and multiple writer() tasks.
 * - SEM_pend() and SEM_post() are used to synchronize
 * access to the message queue.
 * - 'id' field was added to MsgObj to specify writer()
 * task id.
 *
 * Unlike a mailbox, a queue can hold an arbitrary number of
 * messages or elements. Each message must, however, be a
 * structure with a QUE_Elem as its first field.
 */

#include <std.h>
#include <log.h>
#include <mem.h>
#include <que.h>
#include <sem.h>
#include <sys.h>
#include <tsk.h>
#include <trc.h>

#define NUMMSGS      3 /* number of messages */
#define NUMWRITERS  3 /* number of writer tasks created with */
                    /* Config Tool */

typedef struct MsgObj {
    QUE_Elem  elem;      /* first field for QUE */
    Int       id;        /* writer task id */
    Char      val;       /* message value */
} MsgObj, *Msg;

Void reader();
Void writer();

/*
 * The following objects are created statically.
 */
extern SEM_Obj sem;

extern QUE_Obj msgQueue;
extern QUE_Obj freeQueue;

extern LOG_Obj trace

```

Example 4.11 SEM Example Using Three Writer Tasks (continued)

```

/*
 * ===== main =====
 */
Void main()
{
    Int          i;
    MsgObj       *msg;
    Uns          mask;

    mask = TRC_LOGTSK | TRC_LOGSWI | TRC_STSSWI | TRC_LOGCLK;
    TRC_enable(TRC_GBLHOST | TRC_GBLTARG | mask);

    msg = (MsgObj *)MEM_alloc(0, NUMMSGs * sizeof(MsgObj), 0);
    if (msg == MEM_ILLEGAL) {
        SYS_abort("Memory allocation failed!\n");
    }

    /* Put all messages on freequeue */
    for (i = 0; i < NUMMSGs; msg++, i++) {
        QUE_put(&freeQueue, msg);
    }
}

/*
 * ===== reader =====
 */
Void reader()
{
    Msg          msg;
    Int          i;

    for (i = 0; i < NUMMSGs * NUMWRITERS; i++) {
        /*
         * Wait for semaphore to be posted by writer().
         */
        SEM_pend(&sem, SYS_FOREVER);

        /* dequeue message */
        msg = QUE_get(&msgQueue);

        /* print value */
        LOG_printf(&trace, "read '%c' from (%d).", msg->val, msg->id);

        /* free msg */
        QUE_put(&freeQueue, msg);
    }
    LOG_printf(&trace, "reader done.");
}

```

Example 4.11 SEM Example Using Three Writer Tasks (continued)

```

/*
 * ===== writer =====
 */
Void writer(Int id)
{
    Msg      msg;
    Int      i;

    for (i = 0; i < NUMMSG; i++) {
        /*
         * Get msg from the free queue. Since reader is
higher
         * priority and only blocks on sem, this queue is
         * never empty.
         */
        if (QUE_empty(&freeQueue)) {
            SYS_abort("Empty free queue!\n");
        }
        msg = QUE_get(&freeQueue);

        /* fill in value */
        msg->id = id;
        msg->val = (i & 0xf) + 'a';
        LOG_printf(&trace, "(%d) writing '%c' ...", id,
msg->val);

        /* enqueue message */
        QUE_put(&msgQueue, msg);

        /* post semaphore */
        SEM_post(&sem);

        /* what happens if you call TSK_yield() here? */
        /* TSK_yield(); */
    }
    LOG_printf(&trace, "writer (%d) done.", id);
}

```



Non-pointer type function arguments to LOG_printf need explicit type casting to (Arg) as shown in the following code example:



```
LOG_printf(&trace, "Task %d Done", (Arg)id);
```

Figure 4–14 Trace Results from Example 4-11

```

(0) writing 'a' ...
read 'a' from (0).
(0) writing 'b' ...
read 'b' from (0).
(0) writing 'c' ...
read 'c' from (0).
writer (0) done.
(1) writing 'a' ...
read 'a' from (1).
(1) writing 'b' ...
read 'b' from (1).
(1) writing 'c' ...
read 'c' from (1).
writer (1) done.
(2) writing 'a' ...
read 'a' from (2).
(2) writing 'b' ...
read 'b' from (2).
(2) writing 'c' ...
read 'c' from (2).
reader done.
writer (2) done.
    
```

4.8 Mailboxes

The MBX module provides a set of functions to manage mailboxes. MBX mailboxes can be used to pass messages from one task to another on the same processor. An intertask synchronization enforced by a fixed length shared mailbox can be used to ensure that the flow of incoming messages does not exceed the ability of the system to process those messages. The examples given in this section illustrate just such a scheme.

The mailboxes managed by the MBX module are separate from the mailbox structure contained within a SWI object.

MBX_create and MBX_delete are used to create and delete mailboxes, respectively. You can also create mailbox objects statically. See Section 2.6, *Creating DSP/BIOS Objects Dynamically*, page 2-37, for a discussion of the benefits of creating objects statically.

You specify the mailbox length and message size when you create a mailbox as shown in Example 4-12.

Example 4-12 Creating a Mailbox

```

MBX_Handle MBX_create(msgsize, mbxlength, attrs)
    Uns      msgsize;
    Uns      mbxlength;
    MBX_Attrs *attrs;

Void MBX_delete(mbx)
    MBX_Handle mbx;
    
```

MBX_pend is used to read a message from a mailbox as shown in Example 4-13. If no message is available (that is, the mailbox is empty), MBX_pend blocks. In this case, the timeout parameter allows the task to wait until a timeout, to wait indefinitely, or to not wait at all.

Example 4-13 Reading a Message from a Mailbox

```

Bool MBX_pend(mbx, msg, timeout)
  MBX_Handle  mbx;
  Void        *msg;
  Uns         timeout;    /* return after this many */
                          /* system clock ticks */

```

Conversely, MBX_post is used to post a message to the mailbox as shown in Example 4-14. If no message slots are available (that is, the mailbox is full), MBX_post blocks. In this case, the timeout parameter allows the task to wait until a timeout, to wait indefinitely, or to not wait at all.

Example 4-14 Posting a Message to a Mailbox

```

Bool MBX_post(mbx, msg, timeout)
  MBX_Handle  mbx;
  Void        *msg;
  Uns         timeout;    /* return after this many */
                          /* system clock ticks */

```

4.8.1 MBX Example

Example 4-15 provides sample code showing two types of tasks created statically: a single reader task which removes messages from the mailbox, and multiple writer tasks which insert messages into the mailbox. The resultant trace from Example 4-15 is shown in Figure 4-15.

Note: When called within an HWI, the code sequence calling MBX_post must be either wrapped within an HWI_enter/HWI_exit pair or invoked by the HWI dispatcher.

Example 4-15 MBX Example With Two Types of Tasks

```

/*
 * ===== mbxtest.c =====
 * Use a MBX mailbox to send messages from multiple writer()
 * tasks to a single reader() task.
 * The mailbox, reader task, and 3 writer tasks are created
 * statically.
 *
 * This example is similar to semtest.c. The major differences
 * are:
 * - MBX is used in place of QUE and SEM.
 * - the 'elem' field is removed from MsgObj.
 * - reader() task is *not* higher priority than writer task.
 * - reader() looks at return value of MBX_pend() for timeout
 */

#include <std.h>

#include <log.h>
#include <mbx.h>
#include <tsk.h>

#define NUMMSGs      3      /* number of messages */
#define TIMEOUT      10

typedef struct MsgObj {
    Int    id;              /* writer task id */
    Char   val;            /* message value */
} MsgObj, *Msg;

/* Mailbox created with Config Tool */
extern MBX_Obj mbx;

/* "trace" Log created with Config Tool */
extern LOG_Obj trace;

Void reader(Void);
Void writer(Int id);

/*
 * ===== main =====
 */
Void main()
{
    /* Does nothing */
}
    
```

Example 4.15 MBX Example With Two Types of Tasks (continued)

```

/*
 * ===== reader =====
 */
Void reader(Void)
{
    MsgObj    msg;
    Int       i;

    for (i=0; ;i++) {

        /* wait for mailbox to be posted by writer() */
        if (MBX_pend(&mbx, &msg, TIMEOUT) == 0) {
            LOG_printf(&trace, "timeout expired for MBX_pend()");
            break;
        }

        /* print value */
        LOG_printf(&trace, "read '%c' from (%d).", msg.val, msg.id);
    }
    LOG_printf(&trace, "reader done.");
}

/*
 * ===== writer =====
 */
Void writer(Int id)
{
    MsgObj    msg;
    Int       i;

    for (i=0; i < NUMMSGs; i++) {
        /* fill in value */
        msg.id = id;
        msg.val = i % NUMMSGs + (Int)('a');

        LOG_printf(&trace, "(%d) writing '%c' ...", id, (Int)msg.val);

        /* enqueue message */
        MBX_post(&mbx, &msg, TIMEOUT);

        /* what happens if you call TSK_yield() here? */
        /* TSK_yield(); */
    }
    LOG_printf(&trace, "writer (%d) done.", id);
}

```

After the program runs, review the trace log contents. The results should be similar to that shown in Figure 4-15.

Figure 4–15 Trace Results from Example 4-15

```

(0) writing 'a' ...
(0) writing 'b' ...
(0) writing 'c' ...
(1) writing 'a' ...
(2) writing 'a' ...
read 'a' from (0).
read 'b' from (0).
writer (0) done.
(1) writing 'b' ...
read 'c' from (0).
read 'a' from (1).
(2) writing 'b' ...
(1) writing 'c' ...
read 'a' from (2).
read 'b' from (1).
(2) writing 'c' ...
writer (1) done.
read 'b' from (2).
read 'c' from (1).
writer (2) done.
read 'c' from (2).
timeout expired for MBX_pend()
reader done.
    
```

Associated with the mailbox at creation time is a total number of available message slots, determined by the mailbox length you specify when you create the mailbox. In order to synchronize tasks writing to the mailbox, a counting semaphore is created and its count is set to the length of the mailbox. When a task does an `MBX_post` operation, this count is decremented. Another semaphore is created to synchronize the use of reader tasks with the mailbox; this counting semaphore is initially set to zero so that reader tasks block on empty mailboxes. When messages are posted to the mailbox, this semaphore is incremented.

In Example 4-15, all the tasks have the same priority. The writer tasks try to post all their messages, but a full mailbox causes each writer to block indefinitely. The readers then read the messages until they block on an empty mailbox. The cycle is repeated until the writers have exhausted their supply of messages.

At this point, the readers pend for a period of time according to the following formula, and then time out:

$$\text{TIMEOUT} * 1\text{ms} / (\text{clock ticks per millisecond})$$

After this timeout occurs, the pending reader task continues executing and then concludes.

At this point, it is a good idea to experiment with the relative effects of scheduling order and priority, the number of participants, the mailbox length, and the wait time by combining the following code modifications:

- Creation order or priority of tasks
- Number of readers and writers
- Mailbox length parameter (`MBXLENGTH`)
- Add code to handle a writer task timeout

4.9 Timers, Interrupts, and the System Clock

DSPs typically have one or more on-device timers which generate a hardware interrupt at periodic intervals. DSP/BIOS normally uses one of the available on-device timers as the source for its own system clock. Using the on-device timer hardware present on most TMS320 DSPs, the CLK module supports time resolutions close to the single instruction cycle.

You define the system clock parameters in the DSP/BIOS configuration settings. In addition to the DSP/BIOS system clock, you can set up additional clock objects for invoking functions each time a timer interrupt occurs.

On the C6000 platform, you can also define parameters for the CLK module's HWI object, since that object is pre-configured to use the HWI dispatcher. This allows you to manipulate the interrupt mask and cache control mask properties of the CLK ISR.

DSP/BIOS provides two separate timing methods—the high- and low-resolution times and the system clock. In the default configuration, the low-resolution time and the system clock are the same. However, your program can drive the system clock using some other event, such as the availability of data. You can disable or enable the CLK Manager's use of the on-device timer to drive high- and low-resolution times. You can drive the system clock using the low-resolution time, some other event, or not at all. The interactions between these two timing methods are shown in Example 4–16.

Figure 4–16 Interactions Between Two Timing Methods

	CLK module drives system clock	Other event drives system clock	No event drives system clock
CLK manager enabled	Default configuration: Low-resolution time and system clock are the same	Low-resolution time and system clock are different	Only low- and high-resolution times available; timeouts don't elapse
CLK manager disabled	Not possible	Only system clock available; CLK functions don't run	No timing method; CLK functions don't run; timeouts don't elapse

4.9.1 High- and Low-Resolution Clocks

Using the CLK Manager in the configuration, you can disable or enable DSP/BIOS' use of an on-device timer to drive high- and low-resolution times on the Clock Manager Properties.

The C6000 platform has multiple general-purpose timers. On the C6000, the configuration allows you to select the on-device timer that is used by the CLK Manager. On all platforms, you can configure the period at which the timer interrupt is triggered. See *CLK Module* in the *TMS320 DSP/BIOS API Reference Guide* for your platform, for more details about these properties. By entering the period of the timer interrupt, DSP/BIOS automatically sets up the appropriate value for the period register.

When the CLK Manager is enabled on the C6000 platform, the timer counter register is incremented every four CPU cycles. When the CLK Manager is enabled on the C28x platform, the timer counter is decremented at the following rate, where CLKOUT is the DSP clock speed in MIPS (see the GBL properties in the *TMS320 DSP/BIOS API Reference Guide* for your platform) and TDDR is the value of the timer divide-down register as shown in the following equation.

$$\text{CLKOUT} / (\text{TDDR} + 1)$$

When this register reaches 0 on the C28x platform, or the value set for the period register on the C6000 platform, the counter is reset. On the C28x, it is reset to the value in the period register. On the C6000, it is reset to 0. At this point, a timer interrupt occurs. When a timer interrupt occurs, the HWI object for the selected timer runs the CLK_F_isr function, which causes these events to occur:

- The low-resolution time is incremented by 1 on the C6000, C2800, and C5000 platforms.
- All the functions specified by CLK objects are performed in sequence in the context of that ISR.

Therefore, the low-resolution clock ticks at the timer interrupt rate and the clock's time is equal to the number of timer interrupts that have occurred. To obtain the low-resolution time, you can call CLK_gettime from your application code.

The CLK functions performed when a timer interrupt occurs are performed in the context of the hardware interrupt that caused the system clock to tick. Therefore, the amount of processing performed within CLK functions should be minimized and these functions can invoke only DSP/BIOS calls that are allowable from within an HWI.

Note: CLK functions should not call HWI_enter and HWI_exit as these are called internally when DSP/BIOS runs CLK_F_isr. Additionally, CLK functions should **not** use the *interrupt* keyword or the INTERRUPT pragma in C functions.

The high-resolution clock ticks at the same rate the timer counter register is incremented on the C6000 platform and decremented on the C28x platforms. Hence, the high-resolution time is the number of times the timer counter register has been incremented or decremented. On the C6000 platform, this is equivalent to the number of instruction cycles divided by 4. The CPU clock rate is high, therefore, the timer counter register can reach the period register value (C6000 platform) or 0 (C28x platform) very quickly.



On the C6000 platform, the 32-bit high-resolution time is calculated by multiplying the low-resolution time (that is, the interrupt count) by the value of the period register and adding the current value of the timer counter register. To obtain the value of the high-resolution time you can call CLK_gettime from your application code. The value of both clock restart at 0 when the maximum 32-bit value is reached.



On the C28x platform, the 32-bit high resolution time is calculated by multiplying the low-resolution time (that is, interrupt count) by the value of the period register, and adding the difference between the period register value and the value of the timer counter register. To obtain the value of the high-resolution time, you can call CLK_gettime from your application code, the value of the clock restart at the value in the period register when 0 is reached.

Other CLK module APIs are CLK_getprd, which returns the value set for the period register in the configuration; and CLK_countspms, which returns the number of timer counter register increments or decrements per millisecond.

Modify the properties of the CLK Manager to configure the low-resolution clock. For example, to make the low-resolution clock tick every millisecond (.001 sec), type 1000 in the CLK Manager's Microseconds/Int field. The configuration automatically calculates the correct value for the period register.



You can directly specify the period register value if you set the Directly configure on-device timer registers property to true. On the C6000 platform, to generate a 1 millisecond (.001 sec) system clock period on a 160 MIPS processor using the CPU clock/4 to drive the clock, the period register value is:

$$\text{Period} = 0.001 \text{ sec} * 160,000,000 \text{ cycles per second} / 4 \text{ cycles} = 40,000$$

To do the same thing on C28x platforms with a 40 MIPS processor using the CPU to drive the clock, the period register value is:

$$\text{Period} = 0.001 \text{ sec} * 40,000,000 \text{ cycles per second} = 40,000$$

4.9.2 System Clock

Many DSP/BIOS functions have a timeout parameter. DSP/BIOS uses a system clock to determine when these timeouts should expire. The system clock tick rate can be driven using either the low-resolution time or an external source.

The TSK_sleep function is an example of a function with a timeout parameter. After calling this function, its timeout expires when a number of ticks equal to the timeout value have passed in the system clock. For example, if the system clock has a resolution of 1 microsecond and we want the current task to block for 1 millisecond, the call should look like this:

```
/* block for 1000 ticks * 1 microsecond = 1 msec */
TSK_sleep(1000)
```

Note: Do not call TSK_sleep or SEM_pend with a timeout other than 0 or SYS_FOREVER if the program is configured without something to drive the PRD module. In a default configuration, the CLK module drives the PRD module.

If you are using the default CLK configuration, the system clock has the same value as the low-resolution time because the PRD_clock CLK object drives the system clock.

There is no requirement that an on-device timer be used as the source of the system clock. An external clock, for example one driven by a data stream rate, can be used instead. If you do not want the on-device timer to drive the low-resolution time, destroy the CLK object named PRD_clock in the configuration script. If an external clock is used, it can call PRD_tick to advance the system clock. Another possibility is having an on-device peripheral such as the codec that is triggering an interrupt at regular intervals, call PRD_tick from that interrupt's HWI. In this case, the resolution of the system call is equal to the frequency of the interrupt that is calling PRD_tick.

4.9.3 Example—System Clock

Example 4-16, clktest.c, shows a simple use of the DSP/BIOS functions that use the system clock, TSK_time and TSK_sleep. The task, labeled task, in clktest.c sleeps for 1000 ticks before it is awakened by the task scheduler. Since no other tasks have been created, the program runs the idle functions while task is blocked. The program assumes that the system clock is configured and driven by PRD_clock. The trace log output for the code in Example 4-16 would be similar to that shown in Example 4-17.

Example 4-16 Using the System Clock to Drive a Task

```

/* ===== clktest.c =====
 * In this example, a task goes to sleep for 1 sec and
 * prints the time after it wakes up. */

#include <std.h>

#include <log.h>
#include <clk.h>
#include <tsk.h>

extern LOG_Obj trace;

/* ===== main ===== */
Void main()
{
    LOG_printf(&trace, "clktest example started.\n");
}

Void taskFxn()
{
    Uns ticks;

    LOG_printf(&trace, "The time in task is: %d ticks",
(Int)TSK_time());

    ticks = (1000 * CLK_countspms()) / CLK_getprd();

    LOG_printf(&trace, "task going to sleep for 1 second... ");
    TSK_sleep(ticks);
    LOG_printf(&trace, "...awake! Time is: %d ticks",
(Int)TSK_time());
}
    
```



Non-pointer type function arguments to LOG_printf need explicit type casting to (Arg) as shown in the following code example:

```
LOG_printf(&trace, "Task %d Done", (Arg)id);
```

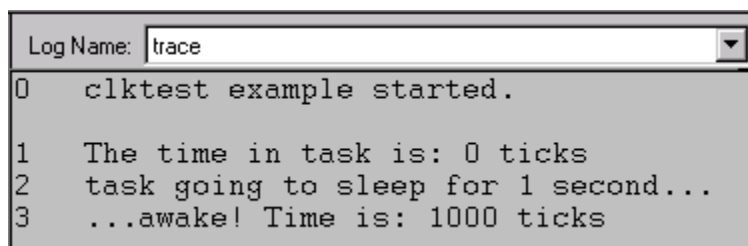
Figure 4-17 Trace Log Output from Example 4-16

```

Log Name: trace
0  clktest example started.
1  The time in task is: 0 ticks
2  task going to sleep for 1 second...
3  ...awake! Time is: 1000 ticks
    
```

4.10 Periodic Function Manager (PRD) and the System Clock

Many applications need to schedule functions based on I/O availability or some other programmed event. Other applications can schedule functions based on a real-time clock.

The PRD Manager allows you to create objects that schedule periodic execution of program functions. To drive the PRD module, DSP/BIOS provides a system clock. The system clock is a 32-bit counter that ticks every time PRD_tick is called. You can use the timer interrupt or some other periodic event to call PRD_tick and drive the system clock.

There can be several PRD objects, but all are driven by the same system clock. The period of each PRD object determines the frequency at which its function is called. The period of each PRD object is specified in terms of the system clock time; that is, in system clock ticks.

To schedule functions based on certain events, use the following procedures:

- **Based on a real-time clock.** Set the Use CLK Manager to Drive PRD property to true for the PRD module properties. By doing this you are setting the timer interrupt used by the CLK Manager to drive the system clock. When you do this a CLK object called PRD_clock is added to the CLK module. This object calls PRD_tick every time the timer interrupt goes off, advancing the system clock by one tick.

Note: When the CLK Manager is used to drive PRD, the system clock that drives PRD functions ticks at the same rate as the low-resolution clock. The low-resolution and system time coincide.

- **Based on I/O availability or some other event.** Set the Use the CLK Manager to Drive PRD property to false for the PRD module properties. Your program should call PRD_tick to increment the system clock. In this case the resolution of the system clock equals the frequency of the interrupt from which PRD_tick is called.

4.10.1 *Invoking Functions for PRD Objects*

When PRD_tick is called two things can occur:

- PRD_D_tick, the system clock counter, increases by one; that is, the system clock ticks.
- An SWI called PRD_swi is posted if the number of PRD_ticks that have elapsed is equal to a value that is the greatest power of two among the common denominators of the PRD function periods. For example, if the periods of three PRD objects are 12, 24, and 36, PRD_swi runs every four ticks. It does not simply run every 12 or 6 ticks because those intervals are not powers of two.

When a PRD object is created statically, a new SWI object is automatically added called PRD_swi.

When PRD_swi runs, its function executes the following type of loop:

```
for ("Loop through period objects") {
    if ("time for a periodic function")
        "run that periodic function";
}
```

Hence, the execution of periodic functions is deferred to the context of PRD_swi, rather than being executed in the context of the HWI where PRD_tick was called. As a result, there can be a delay between the time the system tick occurs and the execution of the periodic objects whose periods have expired with the tick. If these functions run immediately after the tick, you should configure PRD_swi to have a high priority with respect to other threads in your application.

4.10.2 *Interpreting PRD and SWI Statistics*

Many tasks in a real-time system are periodic; that is, they execute continuously and at regular intervals. It is important that such tasks finish executing before it is time for them to run again. A failure to complete in this time represents a missed real-time deadline. While internal data buffering can be used to recover from occasional missed deadlines, repeated missed deadlines eventually result in an unrecoverable failure.

The implicit statistics gathered for SWI functions measure the time from when a software interrupt is ready to run and the time it completes. This timing is critical because the processor is actually executing numerous hardware and software interrupts. If a software interrupt is ready to execute but must wait too long for other software interrupts to complete, the real-time deadline is missed. Additionally, if a task starts executing, but is interrupted too many times for too long a period of time, the real-time deadline is also missed.

The maximum ready-to-complete time is a good measure of how close the system is to potential failure. The closer a software interrupt's maximum ready-to-complete time is to its period, the more likely it is that the system cannot survive occasional bursts of activity or temporary data-dependent increases in computational requirements. The maximum ready-to-complete time is also an indication of how much headroom exists for future product enhancements (which invariably require more MIPS).

Note: DSP/BIOS does not implicitly measure the amount of time each software interrupt takes to execute. This measurement can be determined by running the software interrupt in isolation using either the simulator or the emulator to count the precise number of execution cycles required.

It is important to realize even when the sum of the MIPS requirements of all routines in a system is well below the MIPS rating of the DSP, the system can not meet its real-time deadlines. It is not uncommon for a system with a CPU load of less than 70% to miss its real-time deadlines due to prioritization problems. The maximum ready-to-complete times monitored by DSP/BIOS, however, provide an immediate indication when these situations exist.

When statistics accumulators for software interrupts and periodic objects are enabled, the host automatically gathers the count, total, maximum, and average for the following types of statistics:

- **SWI.** Statistics about the period elapsed from the time the software interrupt was posted to its completion.
- **PRD.** The number of periodic system ticks elapsed from the time the periodic function is ready to run until its completion. By definition, a periodic function is ready to run when period ticks have occurred, where period is the *period* parameter for this object.

You can set the units for the SWI completion period by setting CLK Manager parameters. This period is measured in instruction cycles if the CLK module's Use high resolution time for internal timings parameter is set to True (the default). If this CLK parameter is set to False, SWI statistics are displayed in units of timer interrupt periods. You can also choose milliseconds or microseconds for Statistics Units on the Statistics Data tool.

For example, if the maximum value for a PRD object increases continuously, the object is probably not meeting its real-time deadline. In fact, the maximum value for a PRD object should be less than or equal to the period (in system ticks) property of this PRD object. If the maximum value is greater than the period, the periodic function has missed its real-time deadline.

Memory and Low-level Functions

This chapter describes the low-level functions found in the DSP/BIOS real-time multitasking kernel. These functions are embodied in the following software modules:

- MEM and BUF, which manage allocation of variable-length and fixed-length memory
- SYS, which provides miscellaneous system services
- QUE, which manages queues

This chapter also presents several simple example programs that use these modules. The API functions are described in greater detail in the *TMS320 DSP/BIOS API Reference Guide* for your platform.

Topic	Page
5.1 Memory Management	143
5.2 System Services	151
5.3 Queues	153

5.1 Memory Management

The Memory Section Manager (MEM module) manages named memory segments that correspond to physical ranges of memory. If you want more control over memory segments, you can create your own linker command file and include the linker command file created when you run the configuration script.

The MEM module also provides a set of functions for dynamically allocating and freeing variable-sized blocks of memory. The BUF module provides a set of functions for dynamically allocating and freeing fixed-sized blocks of memory.

Unlike standard C functions like malloc, the MEM functions enable you to specify which segment of memory is used to satisfy a particular request for storage. Real-time DSP hardware platforms typically contain several different types of memory: fast, on-device RAMs; zero wait-state external SRAMs; slower DRAMs for bulk data; and several others. Having explicit control over which memory segment contains a particular block of data is essential to meeting real-time constraints in many DSP applications.

The MEM module does not set or configure hardware registers associated with a DSPs memory subsystem. Such configuration is your responsibility and is typically handled by software loading programs, or in the case of Code Composer Studio, the GEL start-up or menu options. For example, to access external memory on a C6000 platform, the External Memory Interface (EMIF) registers must first

be set appropriately before any access. The earliest opportunity for EMIF initialization within DSP/BIOS would be during the user initialization function (see *Global Settings* in the *TMS320 DSP/BIOS API Reference Guide* for your platform).

The MEM functions allocate and free variable-sized memory blocks. Memory allocation and freeing are non-deterministic when using the MEM module, since this module maintains a linked list of free blocks for each particular memory segment. MEM_alloc and MEM_free must transverse this linked list when allocating and freeing memory.

5.1.1 **Configuring Memory Segments**

The templates provided with DSP/BIOS define a set of memory segments. These segments are somewhat different for each supported DSP board. If you are using a hardware platform for which there is no configuration template, you need to customize the MEM objects and their properties. You can customize MEM segments in the following ways:

- Insert a new MEM segment and define its properties. For details on MEM object properties, see the *TMS320 DSP/BIOS API Reference Guide* for your platform.
- Change the properties of an existing MEM segment.
- Delete some MEM segments, particularly those that correspond to external memory locations. However, you must first change any references to that segment made in the properties of other objects and managers. To find dependencies on a particular MEM segment, right-click on that segment and select Show Dependencies from the pop-up menu. Deleting or renaming the IPRAM and IDRAM (C6000 platform) or IPROG and IDATA (C5000 platform) segments is not recommended.
- Rename some MEM segments. To rename a segment, follow these steps:
 - a) Remove dependencies to the segment you want to rename. To find dependencies on a particular MEM segment, right-click on that segment and select Show Dependencies from the pop-up menu.
 - b) Rename the segment. You can right-click on the segment name and choose Rename from the pop-up menu to edit the name.
 - c) Recreate dependencies on this segment as needed by selecting the new segment name in the properties for other objects.

5.1.2 **Disabling Dynamic Memory Allocation**

If small code size is important to your application, you can reduce code size significantly by removing the capability to dynamically allocate and free memory. If you remove this capability, your program cannot call any of the MEM functions or any object creation functions (such as TSK_create). You should create all objects that are used by your program in the configuration.

To remove the dynamic memory allocation capability, set the No Dynamic Memory Heaps properties for the MEM Manager to true.

If dynamic memory allocation is disabled and your program calls a MEM function (or indirectly calls a MEM function by calling an object creation function), an error occurs. If the segid passed to the MEM function is the name of a segment, a link error occurs. If the segid passed to the MEM function is an integer, the MEM function will call SYS_error.

5.1.3 Defining Segments in Your Own Linker Command File

The MEM Manager allows you to select which memory segments contain various types of code and data. If you want more control over where these items are stored, set the User .cmd file for non-DSP/BIOS segments property in the properties for the MEM Manager to true.

You should then create your own linker command file that begins by including the linker command file created by running the configuration script. For example, your own linker command file might look like one of those shown in Example 5-1 or Example 5-2.

Example 5-1 Linker Command File (C6000 Platform)



```

/* First include DSP/BIOS generated cmd file. */
-l designcfg.cmd

SECTIONS {
  /* place high-performance code in on-device ram */
  .fast_text: {
    myfastcode.lib*(.text)
    myfastcode.lib*(.switch)
  } > IPRAM

  /* all other user code in off device ram */
  .text:      {} > SDRAM0
  .switch:   {} > SDRAM0
  .cinit:    {} > SDRAM0
  .pinit:    {} > SDRAM0

  /* user data in on-device ram */
  .bss:      {} > IDRAM
  .far:      {} > IDRAM
}

```

Example 5-2 Linker Command File (C55x and C28x Platforms)



```

/* First include DSP/BIOS generated cmd file. */
-l designcfg.cmd

SECTIONS {
  /* place high-performance code in on-device ram */
  .fast_text: {
    myfastcode.lib*(.text)
    myfastcode.lib*(.switch)
  } > IPROG PAGE 0

  /* all other user code in off device ram */
  .text:      {} > EPROG0 PAGE 0
  .switch:   {} > EPROG0 PAGE 0
  .cinit:    {} > EPROG0 PAGE 0
  .pinit:    {} > EPROG0 PAGE 0

  /* user data in on-device ram */
  .bss:      {} > IDATA PAGE 1
  .far:      {} > IDATA PAGE 1
}

```

5.1.4 Allocating Memory Dynamically

DSP/BIOS provides functions in two modules for dynamic memory allocation: MEM and BUF. The MEM module allocates variable-size blocks of memory. The BUF module allocates fixed-size buffers from buffer pools.

5.1.4.1 Memory Allocation with the MEM Module

Basic storage allocation may be handled using MEM_alloc, whose parameters specify a memory segment, a block size, and an alignment as shown in Example 5-3. If the memory request cannot be satisfied, MEM_alloc returns MEM_ILLEGAL.

Example 5-3 Using MEM_alloc for System-Level Storage

```
Ptr MEM_alloc(segid, size, align)
Int segid;
Uns size;
Uns align;
```

The segid parameter identifies the memory segment from which memory is to be allocated. This identifier can be an integer or a memory segment name defined in the configuration.

The memory block returned by MEM_alloc contains at least the number of minimum addressable data units (MADUs) indicated by the size parameter. A minimum addressable unit for a processor is the smallest datum that can be loaded or stored in memory. An MADU can be viewed as the number of bits between consecutive memory addresses. The number of bits in an MADU varies with different DSP devices, for example, the MADU for the C5000 platform is a 16-bit word, and the MADU for the C6000 platform is an 8-bit byte.

The memory block returned by MEM_alloc starts at an address that is a multiple of the align parameter; no alignment constraints are imposed if align is 0. An array of structures might be allocated as shown in Example 5-4.

Example 5-4 Allocating an Array of Structures

```
typedef struct Obj {
    Int    field1;
    Int    field2;
    Ptr    objArr;
} Obj;

objArr = MEM_alloc(SRAM, sizeof(Obj) * ARRAYLEN, 0);
```

Many DSP algorithms use circular buffers that can be managed more efficiently on most DSPs if they are aligned on a power of 2 boundary. This buffer alignment allows the code to take advantage of circular addressing modes found in many DSPs.

If no alignment is necessary, align should be 0. MEM's implementation aligns memory on a boundary equal to the number of words required to hold a MEM_Header structure, even if align has a value of 0. Other values of align cause the memory to be allocated on an align word boundary, where align is a power of 2.

MEM_free frees memory obtained with a previous call to MEM_alloc, MEM_calloc, or MEM_valloc. The parameters to MEM_free—segid, ptr, and size—specify a memory segment, a pointer, and a block size respectively, as shown in Example 5-5. The values of these parameters must be the same as those used when allocating the block of storage.

Example 5-5 Using MEM_free to Free Memory

```
Void MEM_free(segid, ptr, size)
    Int segid;
    Ptr ptr;
    Uns size;
```

Example 5-6 displays a function call which frees the array of objects allocated in Example 5-5.

Example 5-6 Freeing an Array of Objects

```
MEM_free(SRAM, objArr, sizeof(Obj) * ARRAYLEN);
```

5.1.4.2 Memory Allocation with the BUF Module

The BUF module maintains pools of fixed-size buffers. These buffer pools can be created statically or dynamically. Dynamically-created buffer pools are allocated from a dynamic memory heap managed by the MEM module. The BUF_create function creates a buffer pool dynamically. Applications typically create buffer pools statically when size and alignment constraints are known at design time. Run-time creation is used when these constraints vary during execution.

Within a buffer pool, all buffers have the same size and alignment. Although each frame has a fixed length, the application can put a variable amount of data in each frame, up to the length of the frame. You can create multiple buffer pools, each with a different buffer size.

Buffers can be allocated and freed from a pool as needed at run-time using the BUF_alloc and BUF_free functions.

The advantages of allocating memory from a buffer pool instead of from the dynamic memory heaps provided by the MEM module include:

- **Deterministic allocation times.** The BUF_alloc and BUF_free functions require a constant amount of time. Allocating and freeing memory through a heap is not deterministic.
- **Callable from all thread types.** Allocating and freeing buffers is atomic and non-blocking. As a result, BUF_alloc and BUF_free can be called from all types of DSP/BIOS threads: HWI, SWI, TSK, and IDL. In contrast, HWI and SWI threads cannot call MEM_alloc.
- **Optimized for fixed-length allocation.** In contrast MEM_alloc is optimized for variable-length allocation.
- **Less fragmentation.** Since the buffers are of fixed-size, the pool does not become fragmented.

5.1.5 Getting the Status of a Memory Segment

You can use MEM_stat to obtain the status of a memory segment in the number of minimum addressable data units (MADUs). In a manner similar to MEM_alloc, MEM_calloc, and MEM_valloc (refer to Example 5-3), the size used and length values are returned by MEM_stat.

If you are using the BUF module, you can call BUF_stat to get statistics for a buffer pool. You can also call BUF_maxbuff to get the maximum number of buffers that have been used in a pool.

5.1.6 Reducing Memory Fragmentation

As mentioned previously, using the BUF module to allocate and free fixed-length buffers from buffer pools reduces memory fragmentation.

Repeatedly allocating and freeing variable-size blocks of memory can lead to memory fragmentation. When this occurs, calls to MEM_alloc can return MEM_ILLEGAL if there is no contiguous block of free memory large enough to satisfy the request. This occurs even if the total amount of memory in free memory blocks is greater than the amount requested.

To minimize memory fragmentation when allocating variable-size memory blocks, you can use separate memory segments for allocations of different sizes as shown in Figure 5–1.

Figure 5–1 Allocating Memory Segments of Different Sizes

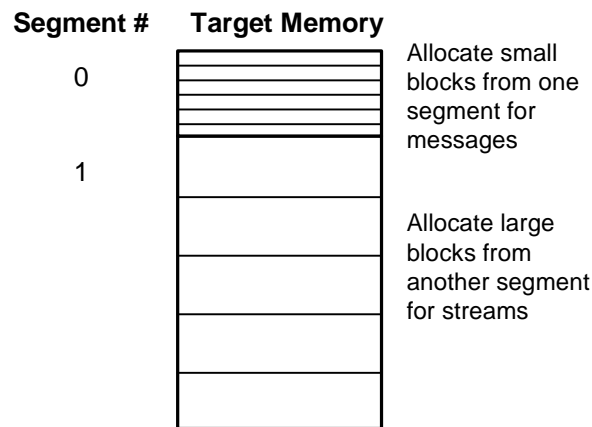

Note: To minimize memory fragmentation, allocate smaller, equal-sized blocks of memory from one memory segment and larger equal-sized blocks of memory from a second segment.

5.1.7 MEM Example

Example 5-7 and Example 5-8 use the functions MEM_stat, MEM_alloc, and MEM_free to highlight several issues involved with memory allocation. Figure 5–2 shows the trace results from Example 5-7 or Example 5-8.

In Example 5-7 and Example 5-8, memory is allocated from IDATA and IDRAM memory using MEM_alloc, and later freed using MEM_free. printmem is used to print the memory status to the trace buffer. The final values (for example, “after freeing...”) should match the initial values.

Example 5-7 Memory Allocation (C5000 and C28x Platforms)

```

/* ===== memtest.c =====
 * This code allocates/frees memory from different memory segments.
 */

#include <std.h>
#include <log.h>
#include <mem.h>

#define NALLOCS 2      /* # of allocations from each segment */
#define BUFSIZE 128   /* size of allocations */

/* "trace" Log created by Configuration Tool */
extern LOG_Obj trace;
#ifdef -28-
extern Int IDATA;
#endif
#ifdef -55-
extern Int DATA;
#endif
static Void printmem(Int segid);
/*
 * ===== main =====
 */
Void main()
{
    Int i;
    Ptr ram[NALLOCS];
    LOG_printf(&trace, "before allocating ...");
    /* print initial memory status */
    printmem(IDATA);
    LOG_printf(&trace, "allocating ...");
    /* allocate some memory from each segment */
    for (i = 0; i < NALLOCS; i++) {
        ram[i] = MEM_alloc(IDATA, BUFSIZE, 0);
        LOG_printf(&trace, "seg %d: ptr = 0x%x", IDATA, ram[i]);
    }
    LOG_printf(&trace, "after allocating ...");
    /* print memory status */
    printmem(IDATA);
    /* free memory */
    for (i = 0; i < NALLOCS; i++) {
        MEM_free(IDATA, ram[i], BUFSIZE);
    }
    LOG_printf(&trace, "after freeing ...");
    /* print memory status */
    printmem(IDATA);
}
/*
 * ===== printmem =====
 */
static Void printmem(Int segid)
{
    MEM_Stat statbuf;
    MEM_stat(segid, &statbuf);
    LOG_printf(&trace, "seg %d: 0 0x%x", segid, statbuf.size);
    LOG_printf(&trace, "\tU 0x%x\tA 0x%x", statbuf.used, stat-
buf.length);
}

```



Non-pointer type function arguments to LOG_printf need explicit type casting to (Arg) as shown in the following code example:

```
LOG_printf(&trace, "Task %d Done", (Arg) id);
```

Example 5-8 Memory Allocation (C6000 Platform)

```

/* ===== memtest.c =====
 * This program allocates and frees memory from
 * different memory segments.
 */

#include <std.h>
#include <log.h>
#include <mem.h>

#define NALLOCES 2      /* # of allocations from each segment */
#define BUFSIZE 128    /* size of allocations */

/* "trace" Log created by Configuration Tool */
extern LOG_Obj trace;
extern Int IDRAM;
static Void printmem(Int segid);

/*
 * ===== main =====
 */
Void main()
{
    Int i;
    Ptr ram[NALLOCES];
    LOG_printf(&trace, "before allocating ...");
    /* print initial memory status */
    printmem(IDRAM);
    LOG_printf(&trace, "allocating ...");
    /* allocate some memory from each segment */
    for (i = 0; i < NALLOCES; i++) {
        ram[i] = MEM_alloc(IDRAM, BUFSIZE, 0);
        LOG_printf(&trace, "seg %d: ptr = 0x%x", IDRAM, ram[i]);
    }
    LOG_printf(&trace, "after allocating ...");
    /* print memory status */
    printmem(IDRAM);
    /* free memory */
    for (i = 0; i < NALLOCES; i++) {
        MEM_free(IDRAM, ram[i], BUFSIZE);
    }
    LOG_printf(&trace, "after freeing ...");
    /* print memory status */
    printmem(IDRAM);
}
/*
 * ===== printmem =====
 */
static Void printmem(Int segid)
{
    MEM_Stat statbuf;
    MEM_stat(segid, &statbuf);
    LOG_printf(&trace, "seg %d: 0 0x%x", segid, statbuf.size);
    LOG_printf(&trace, "\tU 0x%x\tA 0x%x", statbuf.used, stat-
buf.length);
}

```

Figure 5–2 Memory Allocation Trace

```

before allocating ...
seg 0: 0 0x400
      U 0x4   A 0x3fc
allocating ...
seg 0: ptr = 0x1090
seg 0: ptr = 0x1010
after allocating ...
seg 0: 0 0x400
      U 0x104  A 0x2fc
after freeing ...
seg 0: 0 0x400
      U 0x4   A 0x3fc

```

The program in Example 5-7 and Example 5-8 gives board-dependent results. O indicates the original amount of memory, U the amount of memory used, and A the length in MADUs of the largest contiguous free block of memory. The addresses you see are likely to differ from those shown in Example 5–2.

5.2 System Services

The SYS module provides a basic set of system services patterned after similar functions normally found in the standard C run-time library. As a rule, DSP/BIOS software modules use the services provided by SYS in lieu of similar C library functions.

You can configure a function to be run whenever the program calls one of these SYS functions. See the SYS reference section in the *TMS320 DSP/BIOS API Reference Guide* for your platform for details.

5.2.1 Halting Execution

SYS provides two functions as seen in Example 5-9 for halting program execution: SYS_exit, which is used for orderly termination; and SYS_abort, which is reserved for catastrophic situations. Since the actions that should be performed when exiting or aborting programs are inherently system-dependent, you can modify configuration settings to invoke your own routines whenever SYS_exit or SYS_abort is called.

Example 5-9 Coding To Halt Program Execution with SYS_exit or SYS_abort

```

Void SYS_exit(status)
  Int status;

Void SYS_abort(format, [arg,] ...)
  String format;
  Arg arg;

```

The functions in Example 5-9 terminate execution by calling whatever routine is specified for the Exit function and Abort function properties of the SYS module. The default exit function is UTL_halt. The default abort function is _UTL_doAbort, which logs an error message and calls _halt. The _halt function is defined in the boot.c file; it loops infinitely with all processor interrupts disabled.

SYS_abort accepts a format string plus an optional set of data values (presumably representing a diagnostic message), which it passes to the function specified for the Abort function property of the SYS module as shown in Example 5-10.

Example 5-10 Using SYS_abort with Optional Data Values

```
(*(Abort_function)) (format, vargs)
```

The single vargs parameter is of type va_list and represents the sequence of arg parameters originally passed to SYS_abort. The function specified for the Abort function property can pass the format and vargs parameters directly to SYS_vprintf or SYS_vsprintf prior to terminating program execution. To avoid the large code overhead of SYS_vprintf or SYS_vsprintf, you can use LOG_error instead to simply print the format string.

SYS_exit likewise calls whatever function is bound to the Exit function property, passing on its original status parameter. SYS_exit first executes a set of handlers registered through the function SYS_atexit as described Example 5-11.

Example 5-11 Using Handlers in SYS_exit

```
(*handlerN) (status)
...
(*handler2) (status)
(*handler1) (status)

(*(Exit_function)) (status)
```

The function SYS_atexit provides a mechanism that enables you to stack up to SYS_NUMHANDLERS (which is set to 8) clean-up routines as shown in Example 5-12. The handlers are executed before SYS_exit calls the function bound to the Exit function property. SYS_atexit returns FALSE when its internal stack is full.

Example 5-12 Using Multiple SYS_NUMHANDLERS

```
Bool SYS_atexit(handler)
    Fxn    handler;
```

5.2.2 Handling Errors

SYS_error is used to handle DSP/BIOS error conditions as shown in Example 5-13. Application programs as well as internal functions use SYS_error to handle program errors.

Example 5-13 DSP/BIOS Error Handling

```
Void SYS_error(s, errno, ...)
    String    s;
    Uns      errno;
```

SYS_error uses whatever function is bound to the Error function property to handle error conditions. The default error function in the configuration template is _UTL_doError, which logs an error message. In Example 5-14, Error function can be configured to use doError which uses LOG_error to print the error number and associated error string.

Example 5-14 Using doError to Print Error Information

```

Void doError(String s, Int errno, va_list ap)
{
    LOG_error("SYS_error called: error id = 0x%x", errno);
    LOG_error("SYS_error called: string = '%s'", s);
}

```

The errno parameter to SYS_error can be a DSP/BIOS error (for example, SYS_EALLOC) or a user error (errno >= 256). See *TMS320 DSP/BIOS API Reference Guide* for your platform for a table of error codes and strings.

Note: Error checking that would increase memory and CPU requirements has been kept to a minimum in the DSP/BIOS APIs. Instead, the API reference documentation specifies constraints for calling DSP/BIOS API functions. It is the responsibility of the application developer to meet these constraints.

5.3 Queues

The QUE module provides a set of functions to manage a list of QUE elements. Though elements can be inserted or deleted anywhere within the list, the QUE module is most often used to implement a FIFO list—elements are inserted at the tail of the list and removed from the head of the list. QUE elements can be any structure whose first field is of type QUE_Elem. In Example 5-15, QUE_Elem is used by the QUE module to enqueue the structure while the remaining fields contain the actual data to be enqueued.

QUE_create and QUE_delete are used to create and delete queues, respectively. Since QUE queues are implemented as linked lists, queues have no maximum size. This is also shown in Example 5-15.

Example 5-15 Managing QUE Elements Using Queues

```

typedef struct QUE_Elem {
    struct QUE_Elem *next;
    struct QUE_Elem *prev;
} QUE_Elem;

typedef struct MsgObj {
    QUE_Elem elem;
    Char val;
} MsgObj;

QUE_Handle QUE_create(attrs)
    QUE_Attrs *attrs;

Void QUE_delete(queue)
    QUE_Handle queue;

```

5.3.1 Atomic QUE Functions

QUE_put and QUE_get are used to atomically insert an element at the tail of the queue or remove an element from the head of the queue. These functions are atomic in that elements are inserted and removed with interrupts disabled. Therefore, multiple threads can safely use these two functions to modify a queue without any external synchronization.

QUE_get atomically removes and returns the element from the head of the queue, whereas, QUE_put atomically inserts the element at the tail of the queue. In both functions, the queue element has type Ptr to avoid unnecessary type casting as shown in Example 5-16.

Example 5-16 Inserting into a Queue Atomically

```
Ptr QUE_get(queue)
    QUE_Handle queue;
Ptr QUE_put(queue, elem)
    QUE_Handle queue;
    Ptr elem;
```

5.3.2 Other QUE Functions

Unlike QUE_get and QUE_put, there are a number of QUE functions that do not disable interrupts when updating the queue. These functions must be used in conjunction with some mutual exclusion mechanism if the queues being modified are shared by multiple threads.

QUE_dequeue and QUE_enqueue are equivalent to QUE_get and QUE_put except that they do not disable interrupts when updating the queue.

QUE_head is used to return a pointer to the first element in the queue without removing the element. QUE_next and QUE_prev are used to scan the elements in the queue—QUE_next returns a pointer to the next element in the queue and QUE_prev returns a pointer to the previous element in the queue.

QUE_insert and QUE_remove are used to insert or remove an element from an arbitrary point within the queue.

Example 5-17 Using QUE Functions with Mutual Exclusion Elements

```
Ptr QUE_dequeue(queue)
    QUE_Handle queue;

Void QUE_enqueue(queue, elem)
    QUE_Handle queue;
    Ptr elem;

Ptr QUE_head(queue)
    QUE_Handle queue;

Ptr QUE_next(qelem)
    Ptr qelem;

Ptr QUE_prev(qelem)
    Ptr qelem;
Void QUE_insert(qelem, elem)
    Ptr qelem;
    Ptr elem;

Void QUE_remove(qelem)
    Ptr qelem;
```

Note: Since QUE queues are implemented as doubly linked lists with a header node, QUE_head, QUE_next, or QUE_prev may return a pointer to the header node itself (for example, calling QUE_head on an empty queue). Be careful not to call QUE_remove and remove this header node.

5.3.3 QUE Example

Example 5-18 uses a QUE queue to send five messages from a writer to a reader task. The functions MEM_alloc and MEM_free are used to allocate and free the MsgObj structures.

The program in Example 5-18 yields the results shown in Figure 5–3. The writer task uses QUE_put to enqueue each of its five messages and then the reader task uses QUE_get to dequeue each message.

Example 5-18 Using QUE to Send Messages

```

/*
 * ===== quetest.c =====
 * Use a QUE queue to send messages from a writer to a read
 * reader.
 *
 * The queue is created by the Configuration Tool.
 * For simplicity, we use MEM_alloc and MEM_free to manage
 * the MsgObj structures. It would be way more efficient to
 * preallocate a pool of MsgObj's and keep them on a 'free'
 * queue. Using the Config Tool, create 'freeQueue'. Then in
 * main, allocate the MsgObj's with MEM_alloc and add them to
 * 'freeQueue' with QUE_put.
 * You can then replace MEM_alloc calls with QUE_get(freeQueue)
 * and MEM_free with QUE_put(freeQueue, msg).
 *
 * A queue can hold an arbitrary number of messages or elements.
 * Each message must, however, be a structure with a QUE_Elem as
 * its first field.
 */

#include <std.h>
#include <log.h>
#include <mem.h>
#include <que.h>
#include <sys.h>

#define NUMMSGS    5      /* number of messages */

typedef struct MsgObj {
    QUE_Elem    elem;      /* first field for QUE */
    Char        val;       /* message value */
} MsgObj, *Msg;

extern QUE_Obj queue;

/* Trace Log created statically */
extern LOG_Obj trace;

Void reader();
Void writer();

```

Example 5.18 Using QUE to Send Messages (continued)

```

/* ===== main ===== */
Void main()
{
    /*
     * Writer must be called before reader to ensure that the
     * queue is non-empty for the reader.
     */
    writer();
    reader();
}

/* ===== reader ===== */
Void reader()
{
    Msg          msg;
    Int          i;
    for (i=0; i < NUMMSGs; i++) {
        /* The queue should never be empty */
        if (QUE_empty(&queue)) {
            SYS_abort("queue error\n");
        }
        /* dequeue message */
        msg = QUE_get(&queue);

        /* print value */
        LOG_printf(&trace, "read '%c'.", msg->val);
        /* free msg */
        MEM_free(0, msg, sizeof(MsgObj));
    }
}

/* ===== writer ===== */
Void writer()
{
    Msg          msg;
    Int          i;
    for (i=0; i < NUMMSGs; i++) {
        /* allocate msg */
        msg = MEM_alloc(0, sizeof(MsgObj), 0);
        if (msg == MEM_ILLEGAL) {
            SYS_abort("Memory allocation failed!\n");
        }
        /* fill in value */
        msg->val = i + 'a';
        LOG_printf(&trace, "writing '%c' ...", msg->val);
        /* enqueue message */
        QUE_put(&queue, msg);
    }
}

```



Non-pointer type function arguments to LOG_printf need explicit type casting to (Arg) as shown in the following code example:

```
LOG_printf(&trace, "Task %d Done", (Arg) id);
```

Figure 5–3 Trace Results from Example 5-18

```
writing 'a' ...  
writing 'b' ...  
writing 'c' ...  
writing 'd' ...  
writing 'e' ...  
read 'a'.  
read 'b'.  
read 'c'.  
read 'd'.  
read 'e'.
```

Input/Output Methods

This chapter provides an overview of DSP/BIOS data transfer methods, and discusses pipes in particular.

Topic	Page
6.1 I/O Overview	158
6.2 Comparing Pipes and Streams	159
6.3 Comparing Driver Models	160
6.4 Data Pipe Manager (PIP Module)	163
6.5 Message Queues	167
6.6 Host Channel Manager (HST Module)	176
6.7 I/O Performance Issues	178

6.1 I/O Overview

At the application level, input and output may be handled by stream, pipe, message queue, or host channel objects. Each type of object has its own module for managing data input and output.

Note: An alternative to pipes and streams is to use the GIO class driver to interface with IOM mini-drivers. The *DSP/BIOS Driver Developer's Guide* (SPRU616) describes the GIO class driver and the IOM mini-driver model.

The information in this chapter related to stream and pipe objects is still relevant if you are using IOM mini-drivers with streams or pipes.

A stream is a channel through which data flows between an application program and an I/O device. This channel can be read-only (input) or write-only (output) as shown in Figure 6–1. Streams provide a simple and universal interface to all I/O devices, allowing the application to be completely ignorant of the details of an individual device's operation.

Figure 6–1 Input/Output Stream

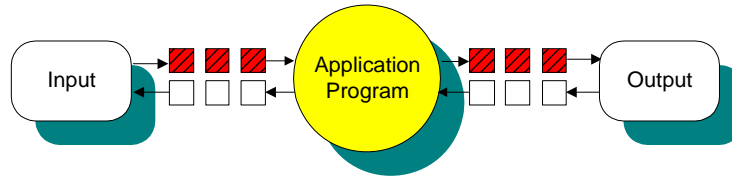

An important aspect of stream I/O is its asynchronous nature. Buffers of data are input or output concurrently with computation. While an application is processing the current buffer, a new input buffer is being filled and a previous one is being output. This efficient management of I/O buffers allows streams to minimize copying of data. Streams exchange pointers rather than data, thus reducing overhead and allowing programs to meet real-time constraints more readily.

A typical program gets a buffer of input data, processes the data, and then outputs a buffer of processed data. This sequence repeats over and over, usually until the program is terminated.

Digital-to-analog converters, video frame grabbers, transducers, and DMA channels are just a few examples of common I/O devices. The stream module (SIO) interacts with these different types of devices through devices (managed by the DEV module) that use the DSP/BIOS programming interface.

Data pipes are used to buffer streams of input and output data. These data pipes provide a consistent software data structure you can use to drive I/O between the DSP device and all kinds of real-time peripheral devices. There is more overhead with a data pipe than with streams, and notification is automatically handled by the pipe manager. All I/O operations on a pipe deal with one frame at a time; although each frame has a fixed length, the application can put a variable amount of data in each frame up to the length of the frame.

Separate pipes should be used for each data transfer thread, and a pipe should only have a single reader and a single writer, providing point to point communication. Often one end of a pipe is controlled by an HWI and the other end is controlled by an SWI function. Pipes can also transfer data between two application threads.

Message queues allow for the structured sending and receiving of variable length messages. This module can be used for messaging between multiple processors. See Section 6.5, *Message Queues* for a description of message queues.

Host channel objects allow an application to stream data between the target and the host. Host channels are statically configured for input or output. Each host channel is internally implemented using a data pipe object.

6.2 Comparing Pipes and Streams

DSP/BIOS supports two different models for data transfer. The pipe model is used by the PIP and HST modules. The stream model is used by the SIO and DEV modules.

Both models require that a pipe or stream have a single reader thread and a single writer thread. Both models transfer buffers within the pipe or stream by copying pointers rather than by copying data between buffers.

In general, the pipe model supports low-level communication, while the stream model supports high-level, device-independent I/O. Table 6–1 compares the two models in more detail.

Table 6–1. Comparison of Pipes and Streams

Pipes (PIP and HST)	Streams (SIO and DEV)
Programmer must create own driver structure.	Provides a more structured approach to device-driver creation.
Reader and writer can be any thread type or host PC.	One end must be handled by a task (TSK) using SIO calls. The other end must be handled by an HWI using Dxx calls.
PIP functions are non-blocking. Program must check to make sure a buffer is available before reading from or writing to the pipe.	SIO_put, SIO_get, and SIO_reclaim are blocking functions and causes a task to wait until a buffer is available. (SIO_issue is non-blocking.)
Uses less memory and is generally faster.	More flexible; generally simpler to use.
Each pipe owns its own buffers.	Buffers can be transferred from one stream to another without copying. (In practice, copying is usually necessary anyway because the data is processed.)
Pipes must be created statically in the configuration.	Streams can be created either at run time or statically in the configuration. Streams can be opened by name.
No built-in support for stacking devices.	Support is provided for stacking devices.
Using the HST module with pipes is an easy way to handle data transfer between the host and target.	A number of device drivers are provided with DSP/BIOS.

6.3 Comparing Driver Models

Below the application level, DSP/BIOS provides two device driver models that enable applications to communicate with DSP peripherals: IOM and SIO/DEV.

- IOM model.** The components of the IOM model are illustrated in the following figure. It separates hardware-independent and hardware-dependent layers. Class drivers are hardware independent; they manage device instances, synchronization and serialization of I/O requests. The lower-level

mini-driver is hardware-dependent. The IOM model can be used with either pipes or streams via the PIO and DIO adapters. See the *DSP/BIOS Driver Developer's Guide* (SPRU616) for more information on the IOM model.

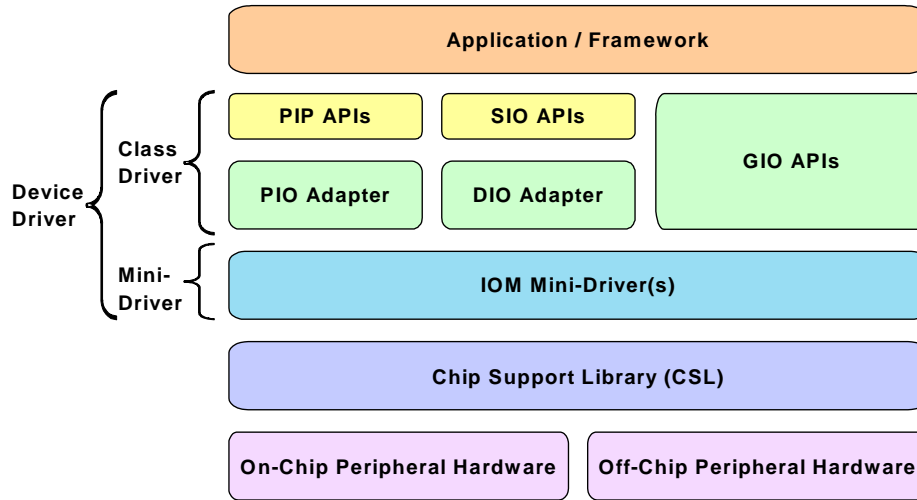

- SIO/DEV model.** This model provides a streaming I/O interface. The application indirectly invokes DEV functions implemented by the device driver managing the physical device attached to the stream, using generic functions provided by the SIO module. The SIO/DEV model cannot be used with pipes. See Chapter 7 for more information on the SIO/DEV model.

For either model, you create a user-defined device object using the DEV module. The model used by this device is identified by its function table type. A type of IOM_Fxns is used with the IOM model. A type of DEV_Fxns is used with the DEV/SIO model.

You can create device objects through static configuration or dynamically through the DEV_createDevice function. The DEV_deleteDevice and DEV_match functions are also provided for managing device objects.

The following sub-sections describe how to create user-defined devices when using various I/O driver objects and models. For details on API function calls and configuration parameters see the *TMS320 DSP/BIOS API Reference Guide* for your platform.

6.3.1 Creating a Device for Use with an IOM Mini-Driver

If you plan to use an IOM mini-driver with the GIO class driver, create a user-defined device statically or with a DEV_createDevice call similar to that shown below:

```

DEV_Attrs gioAttrs = {
    NULL,          /* device id */
    NULL,          /* device parameters */
    DEV_IOMTYPE,  /* type of the device */
    NULL          /* device global data ptr */
};

status = DEV_createDevice("/codec", &DSK6X_EDMA_IOMFXNS,
                          (Fxn)DSK6X_IOM_init, &gioAttrs);
  
```

6.3.2 Creating a Device for Use with Streams and the DIO Adapter

If you plan to use an IOM mini-driver with SIO streams and the DIO adapter, create a user-defined device statically or with a `DEV_createDevice` call similar to that shown below:

```
DIO_Params dioCodecParams = {
    "/codec",          /* device name */
    NULL,             /* chanParams */
};

DEV_Attrs dioCodecAttrs = {
    NULL,             /* device id */
    &dioCodecParams, /* device parameters */
    DEV_SIOCTYPE,    /* type of the device */
    NULL,            /* device global data ptr */
};

status = DEV_createDevice("/dio_codec", &DIO_tskDynamicFxn,
                          (Fxn)DIO_init, &dioCodecAttrs);
```

The driver function table passed to `DEV_createDevice` should be `DIO_tskDynamicFxn` for use with tasks (TSKs) or `DIO_cbDynamicFxn` for use with software interrupts (SWIs).

6.3.3 Creating a Device for Use with the SIO/DEV Model

If you plan to use SIO streams with the SIO/DEV model and a device driver that uses the `DEV_Fxn` function table type, create a user-defined device statically or with a `DEV_createDevice` call similar to that shown below:

```
DEV_Attrs devAttrs = {
    NULL,             /* device id */
    NULL,             /* device parameters */
    DEV_SIOCTYPE,    /* type of the device */
    NULL,            /* device global data ptr */
};

status = DEV_createDevice("/codec", &DSK6X_EDMA_DEVFXNS,
                          (Fxn)DSK6X_DEV_init, &devAttrs);
```

The device function tables passed to `DEV_createDevice` should be of type `DEV_Fxn`.

6.3.4 Creating a Device for Use with Provided Software Drivers

DSP/BIOS provides several software drivers that use the SIO/DEV model. These are described in the DEV module section of the *TMS320 DSP/BIOS API Reference Guide* for your platform. Creating the user-defined device for these drivers is similar to creating a user-defined device for other SIO/DEV model drivers.

6.4 Data Pipe Manager (PIP Module)

Pipes are designed to manage block I/O (also called stream-based or asynchronous I/O). Each pipe object maintains a buffer divided into a fixed number of fixed length frames, specified by the `numframes` and `framesize` properties. All I/O operations on a pipe deal with one frame at a time. Although each frame has a fixed length, the application can put a variable amount of data in each frame (up to the length of the frame).

As shown in Figure 6–2, a pipe has two ends. The writer end is where the program writes frames of data. The reader end is where the program reads frames of data.

Figure 6–2 The Two Ends of a Pipe

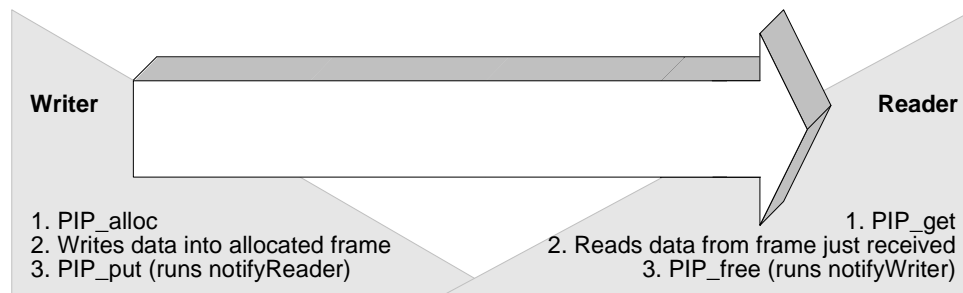

Data notification functions (`notifyReader` and `notifyWriter`) are performed to synchronize data transfer. These functions are triggered when a frame of data is read or written to notify the program that a frame is free or data is available. These functions are performed in the context of the function that calls `PIP_free` or `PIP_put`. They can also be called from the thread that calls `PIP_get` or `PIP_alloc`. When `PIP_get` is called, DSP/BIOS checks whether there are more full frames in the pipe. If so, the `notifyReader` function is executed. When `PIP_alloc` is called, DSP/BIOS checks whether there are more empty frames in the pipe. If so, the `notifyWriter` function is executed.

A pipe should have a single reader and a single writer. Often, one end of a pipe is controlled by an HWI and the other end is controlled by a software interrupt function. Pipes can also be used to transfer data within the program between two application threads.

During program startup (which is described in detail in Section 2.10, *DSP/BIOS Startup Sequence*, page 2-43), the `BIOS_start` function enables the DSP/BIOS modules. As part of this step, the `PIP_startup` function calls the `notifyWriter` function for each pipe object, since at startup all pipes have available empty frames.

There are no special format or data type requirements for the data to be transferred by a pipe.

The DSP/BIOS online help describes data pipe objects and their parameters. See *PIP Module* in the *TMS320 DSP/BIOS API Reference Guide* for your platform for information on the PIP module API.

6.4.1 Writing Data to a Pipe

The steps that a program should perform to write data to a pipe are as follows:

1. A function should first check the number of empty frames available to be filled with data. To do this, the program must check the return value of `PIP_getWriterNumFrames`. This function call returns the number of empty frames in a pipe object.
2. If the number of empty frames is greater than 0, the function then calls `PIP_alloc` to get an empty frame from the pipe.

3. Before returning from the PIP_alloc call, DSP/BIOS checks whether there are additional empty frames available in the pipe. If so, the notifyWriter function is called at this time.
4. Once PIP_alloc returns, the empty frame can be used by the application code to store data. To do this the function needs to know the frame's start address and its size. The API function PIP_getWriterAddr returns the address of the beginning of the allocated frame. The API function PIP_getWriterSize returns the number of words that can be written to the frame. (The default value for an empty frame is the configured frame size.)
5. When the frame is full of data, it can be returned to the pipe. If the number of words written to the frame is less than the frame size, the function can specify this by calling the PIP_setWriterSize function. Afterwards, call PIP_put to return the data to the pipe.
6. Calling PIP_put causes the notifyReader function to run. This enables the writer thread to notify the reader thread that there is data available in the pipe to be read.

The code fragment in Figure 6-1 demonstrates how to write data to a pipe.

Example 6-1 Writing Data to a Pipe

```
extern far PIP_Obj writerPipe; /* created statically */

writer()
{
    Uns size;
    Uns newsize;
    Ptr addr;

    if (PIP_getWriterNumFrames(&writerPipe) > 0) {
        PIP_alloc(&writerPipe); /* allocate an empty frame */
    }
    else {
        return; /* There are no available empty frames */
    }

    addr = PIP_getWriterAddr(&writerPipe);
    size = PIP_getWriterSize(&writerPipe);

    ' fill up the frame '

    /* optional */
    newsize = 'number of words written to the frame';
    PIP_setWriterSize(&writerPipe, newsize);

    /* release the full frame back to the pipe */
    PIP_put (&writerPipe);
}
```

6.4.2 Reading Data from a Pipe

To read a full frame from a pipe, a program should perform the following steps:

1. The function should first check the number of full frames available to be read from the pipe. To do this, the program must check the return value of PIP_getReaderNumFrames. This function call returns the number of full frames in a pipe object.
2. If the number of full frames is greater than 0, the function then calls PIP_get to get a full frame from the pipe.
3. Before returning from the PIP_get call, DSP/BIOS checks whether there are additional full frames available in the pipe. If so, the notifyReader function is called at this time.

4. Once PIP_get returns, the data in the full frame can be read by the application. To do this the function needs to know the frame's start address and its size. The API function PIP_getReaderAddr returns the address of the beginning of the full frame. The API function PIP_getReaderSize returns the number of valid data words in the frame.
5. When the application has finished reading all the data, the frame can be returned to the pipe by calling PIP_free.
6. Calling PIP_free causes the notifyWriter function to run. This enables the reader thread to notify the writer thread that there is a new empty frame available in the pipe.

The code fragment in Example 6-2 demonstrates how to read data from a pipe.

Example 6-2 Reading Data from a Pipe

```
extern far PIP_Obj readerPipe; /* created statically */

reader()
{
    Uns size;
    Ptr addr;

    if (PIP_getReaderNumFrames(&readerPipe) > 0) {
        PIP_get(&readerPipe); /* get a full frame */
    }
    else {
        return; /* There are no available full frames */
    }

    addr = PIP_getReaderAddr(&readerPipe);
    size = PIP_getReaderSize(&readerPipe);

    ' read the data from the frame '

    /* release the empty frame back to the pipe */
    PIP_free(&readerPipe);
}
```

6.4.3 Using a Pipe's Notify Functions

The reader or writer threads of a pipe can operate in a polled mode and directly test the number of full or empty frames available before retrieving the next full or empty frame. The examples in Section 6.4.1, *Writing Data to a Pipe*, page 6-163, and Section 6.4.2, *Reading Data from a Pipe*, page 6-164, demonstrate this type of polled read and write operation.

When used to buffer real-time I/O streams written (read) by a hardware peripheral, pipe objects often serve as a data channel between the HWI routine triggered by the peripheral itself and the program function that ultimately reads (writes) the data. In such situations, the application can effectively synchronize itself with the underlying I/O stream by configuring the pipe's notifyReader (notifyWriter) function to automatically post a software interrupt that runs the reader (writer) function.

When the HWI routine finishes filling up (reading) a frame and calls PIP_put (PIP_free), the pipe's notify function can be used to automatically post a software interrupt. In this case, rather than polling the pipe for frame availability, the reader (writer) function runs only when the software interrupt is triggered; that is, when frames are available to be read (written).

Such a function would not need to check for the availability of frames in the pipe, since it is called only when data is ready. As a precaution, the function can still check whether frames are ready, and if not, cause an error condition, as in the following example code

```

if (PIP_getReaderNumFrames(&readerPipe) = 0) {
error(); /* reader function should not have been posted! */
}
    
```

Hence, the notify function of pipe objects can serve as a flow-control mechanism to manage I/O to other threads and hardware devices.

6.4.4 Calling Order for PIP APIs

Each pipe object internally maintains a list of empty frames and a counter with the number of empty frames on the writer side of the pipe, and a list of full frames and a counter with the number of full frames on the reader side of the pipe. The pipe object also contains a descriptor of the current writer frame (that is, the last frame allocated and currently being filled by the application) and the current reader frame (that is, the last full frame that the application got and that is currently reading).

When PIP_alloc is called, the writer counter is decreased by one. An empty frame is removed from the writer list and the writer frame descriptor is updated with the information from this frame. When the application calls PIP_put after filling the frame, the reader counter is increased by one, and the writer frame descriptor is used by DSP/BIOS to add the new full frame to the pipe's reader list.

Note: Every call to PIP_alloc must be followed by a call to PIP_put before PIP_alloc can be called again: the pipe I/O mechanism does not allow consecutive PIP_alloc calls. Doing so would overwrite previous descriptor information and would produce undetermined results. This is shown in Example 6-3.

Example 6-3 Using PIP_alloc

/* correct */	/* error! */
PIP_alloc();	PIP_alloc();
...	...
PIP_put();	PIP_alloc();
...	...
PIP_alloc();	PIP_put();
...	...
PIP_put();	PIP_put();

Similarly when PIP_get is called, the reader counter is decreased by one. A full frame is removed from the reader list and the reader frame descriptor is updated with the information from this frame. When the application calls PIP_free after reading the frame, the writer counter is increased by one, and the reader frame descriptor is used by DSP/BIOS to add the new empty frame to the pipe's writer list. Hence, every call to PIP_get must be followed by a call to PIP_free before PIP_get can be called again as shown in Example 6-4.

The pipe I/O mechanism does not allow consecutive PIP_get calls. Doing so would overwrite previous descriptor information and produce undetermined results.

Example 6-4 Using PIP_get

```

/* correct */      /* error! */
PIP_get();         PIP_get();
...               ...
PIP_free();        PIP_get();
...               ...
PIP_get();         PIP_free();
...               ...
PIP_free();        PIP_free();

```

6.4.4.1 Avoiding Recursion Problems

Care should be applied when a pipe's notify function calls PIP APIs for the same pipe.

Consider the following example: A pipe's notifyReader function calls PIP_get for the same pipe. The pipe's reader is an HWI routine. The pipe's writer is an SWI routine. Hence the reader has higher priority than the writer. (Calling PIP_get from the notifyReader in this situation can make sense because this allows the application to get the next full buffer ready to be used by the reader—the HWI routine—as soon as it is available and before the hardware interrupt is triggered again.)

The pipe's reader function, the HWI routine, calls PIP_get to read data from the pipe. The pipe's writer function, the SWI routine, calls PIP_put. Since the call to the notifyReader happens within PIP_put in the context of the current routine, a call to PIP_get also happens from the SWI writer routine.

Hence, in the example described two threads with different priorities call PIP_get for the same pipe. This could have catastrophic consequences if one thread preempts the other and as a result, PIP_get is called twice before calling PIP_free, or PIP_get is preempted and called again for the same pipe from a different thread.

Note: As a general rule to avoid recursion, you should avoid calling PIP functions as part of notifyReader and notifyWriter. If necessary for application efficiency, such calls should be protected to prevent reentrancy for the same pipe object and the wrong calling sequence for the PIP APIs.

6.5 Message Queues

The MSGQ module supports the structured sending and receiving of variable length messages. This module can be used for homogeneous or heterogeneous multi-processor messaging. A substantially similar MSGQ API is implemented in DSP/BIOS Link for certain TI general-purpose processors (GPPs), particularly those used in OMAP devices.

MSGQ provides more sophisticated messaging than other modules. It is typically used for complex situations such as multi-processor messaging. The following are key features of the MSGQ module:

- Writers and readers can be relocated to another processor with no runtime code changes.
- Timeouts are allowed when receiving messages.
- Readers can determine the writer and reply back.
- Receiving a message is deterministic when the timeout is zero.

- Sending a message is deterministic (the call, but not the delivery).
- Messages can reside on any message queue.
- Supports zero-copy transfers.
- Can send and receive from HWIs, SWIs and TSKs.
- Notification mechanism is specified by application.
- Allows QoS (quality of service) on message buffer pools. For example, using specific buffer pools for specific message queues.

Messages are sent and received via a *message queue*. A reader is a thread that gets (reads) messages from a message queue. A writer is a thread that puts (writes) a message to a message queue. Each message queue has one reader and can have many writers. A thread may read from or write to multiple message queues.

Figure 6–3 Writers and Reader of a Message Queue

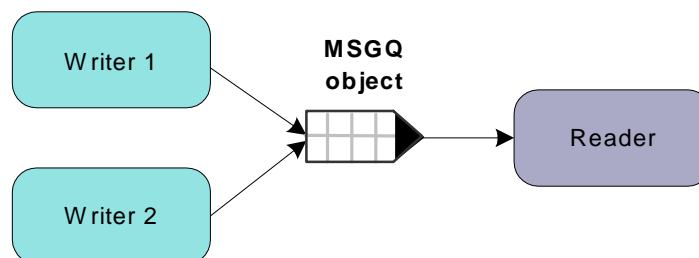

Conceptually, the reader thread owns a message queue. The reader thread opens a message queue. Writer threads locate existing message queues to get access to them.

Messages must be allocated from the MSGQ module. Once a message is allocated, it can be sent on any message queue. Once a message is sent, the writer loses ownership of the message and should not attempt to modify the message. Once the reader receives the message, it owns the message. It may either free the message or re-use the message.

Messages in a message queue can be of variable length. The only requirement is that the first field in the definition of a message must be a `MSGQ_MsgHeader` element.

```
typedef struct MyMsg {
    MSGQ_MsgHeader header;
    ...
} MyMsg;
```

The MSGQ API uses the `MSGQ_MsgHeader` internally. Your application should not modify or directly access the fields in the `MSGQ_MsgHeader`.

The MSGQ module has the following components:

- **MSGQ API.** Applications call the MSGQ functions to open and use a message queue object to send and receive messages. For an overview, see “MSGQ APIs” on page 169. For details, see the sections on the individual APIs.
- **Allocators.** Messages sent via MSGQ must be allocated by an allocator. The allocator determines where and how the memory for the message is allocated. For more about allocators, see “Allocators” on page 172.

- **Transports.** Transports are responsible for locating and sending messages with other processors. For more about transports, see “Transports” on page 172.

Figure 6–4 Components of the MSGQ Architecture

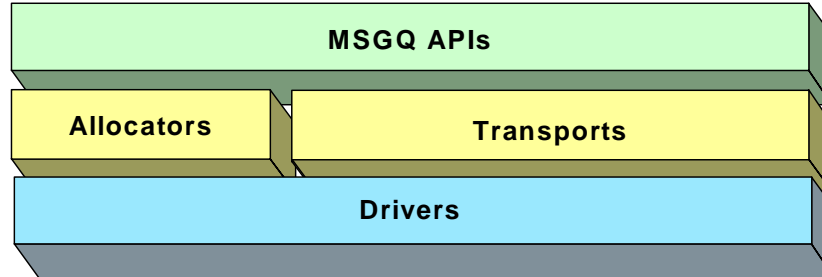

Allocators and transports have a standard interface. The allocator and transport interface functions are called by the MSGQ functions and not by the application. DSP/BIOS provides a simple static allocator; other allocators and transports can be implemented by following the standard interface.

Note: This document does not discuss how to write an allocator or a transport. Information about designing allocators and transports will be provided in a future document.

6.5.1 MSGQ APIs

The MSGQ APIs are used to open and close message queues and to send and receive messages. The MSGQ APIs shield the application from having to contain any knowledge about transports and allocators.

The following figure shows the call sequence of the main MSGQ functions:

Figure 6–5 MSGQ Function Calling Sequence

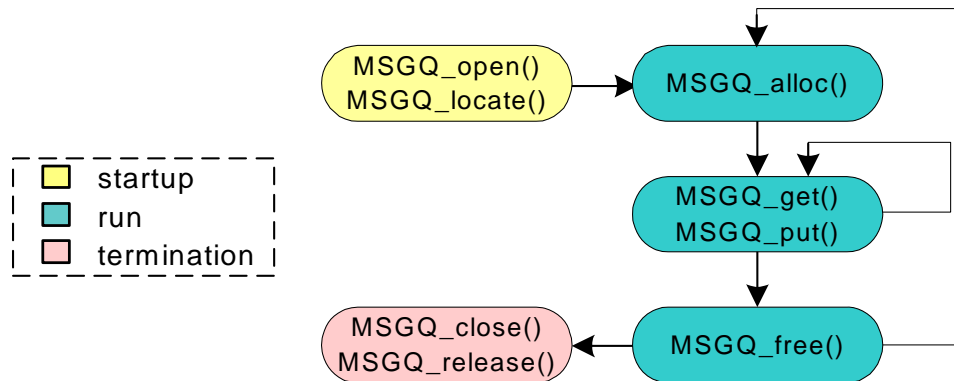

The reader calls the following APIs:

- MSGQ_open
- MSGQ_get
- MSGQ_free
- MSGQ_close

A writer calls the following APIs:

- MSGQ_locate or MSGQ_locateAsync
- MSGQ_alloc
- MSGQ_put
- MSGQ_release

Wherever possible, the MSGQ APIs have been written to have a deterministic execution time. This allows application designers to be certain that messaging will not consume an unknown number of cycles.

In addition, the MSGQ functions support use of message queues from all types of DSP/BIOS threads: HWIs, SWIs, and TSKs. That is, calls that may be synchronous (blocking) have an asynchronous (non-blocking) alternative.

6.5.2 Static Configuration

In order to use the MSGQ module and the allocators it depends upon, you must statically configure the following:

- MSGQ_config variable in application code (see below)
- ENABLEMSGQ property of the MSGQ module in the .tcf file
- PROCID property of the GBL module in the .tcf file
- ENABLEPOOL property of the POOL module in the .tcf file
- POOL_config variable in application code

See the *DSP/BIOS Application Programming Interface Guide* for your platform for information about setting the properties mentioned in this list.

An application must provide a filled in MSGQ_config variable in order to use the MSGQ module.

```
MSGQ_Config MSGQ_config;
```

The MSGQ_Config type has the following structure:

```
typedef struct MSGQ_Config {
    MSGQ_Obj      *msgqQueues;      /* Array of message queue handles */
    MSGQ_TransportObj *transports; /* Array of transports */
    Uint16        numMsgqQueues;    /* Number of message queue handles*/
    Uint16        numProcessors;    /* Number of processors */
    Uint16        startUninitialized; /* First msgq to init */
    MSGQ_Queue    errorQueue;      /* Receives async transport errors*/
    Uint16        errorPoolId;     /* Alloc error msgs from poolId */
} MSGQ_Config;
```

The fields in the MSGQ_Config structure are described in the following table:

Field	Type	Description
msgqQueues	MSGQ_Obj *	Array of message queue objects. The fields of each object do not need to be initialized.
transports	MSGQ_TransportObj *	Array of transport objects. The fields of each object must be initialized.

Field	Type	Description
numMsgQueues	Uint16	Length of the msgQueues array.
numProcessors	Uint16	Length of the transports array.
startUninitialized	Uint16	Index of the first message queue to initialize in the msgQueue array. This should be set to 0.
errorQueue	MSGQ_Queue	Message queue to receive transport errors. Initialize to MSGQ_INVALIDMSGQ.
errorPoolId	Uint16	Allocator to allocate transport errors. Initialize to POOL_INVALIDID.

Internally, MSGQ references its configuration via the MSGQ_config variable. If the MSGQ module is enabled (via the .tcf configuration file) but the application does not provide the MSGQ_config variable, the application cannot be linked successfully.

In the MSGQ_Config structure, and array of MSGQ_TransportObj items defines transport objects with the following structure:

```
typedef struct MSGQ_TransportObj {
    MSGQ_MqtInit  initFxn;    /* Transport init func */
    MSGQ_TransportFxn *fxns; /* Interface funcs */
    Ptr          params; /* Setup parameters */
    Ptr          object; /* Transport-specific object */
    Uint16      procId; /* Processor Id talked to */
} MSGQ_TransportObj;
```

The following table describes the fields in the MSGQ_TransportObj structure:

Field	Type	Description
initFxn	MSGQ_MqtInit	Initialization function for this transport. This function is called during DSP/BIOS startup. More explicitly it is called before main().
fxns	MSGQ_TransportFxn *	Pointer to the transport's interface functions.
params	Ptr	Pointer to the transport's parameters. This field is transport-specific. Please see documentation provided with your transport for a description of this field.
info	Ptr	State information needed by the transport. This field is initialized and managed by the transport. Refer to the specific transport implementation to determine how to use this field
proclD	Uint16	Numeric ID of the processor that this transport communicates with. The current processor must have a proclD field that matches the GBL.PROCID property.

If no parameter structure is specified (that is, MSGQ_NOTTRANSPORT is used) in the MSGQ_TransportObj, the transport uses its default parameters.

The following is an example MSGQ configuration for a single-processor application.

```
#define NUMMSGQUEUES 4 /* # of local message queues*/
#define NUMPROCESSORS 1 /* Single processor system */

static MSGQ_Obj      msgQueues [NUMMSGQUEUES];
static MSGQ_TransportObj transports [NUMPROCESSOR] =
    {MSGQ_NOTTRANSPORT};

MSGQ_Config MSGQ_config = {
    msgQueues,
    transports,
    NUMMSGQUEUES,
    NUMPROCESSORS,
    0,
    MSGQ_INVALIDMSGQ,
    POOL_INVALIDID
};
```

6.5.3 Allocators

All messages sent via the MSGQ module must be allocated by an allocator. The allocator determines where and how the memory for the message is allocated.

An allocator is an instance of an implementation of the allocator interface. An application may instantiate one or more instances of an allocator.

The POOL module describes standard interface functions that allocators must provide. The allocator interface functions are called internally by the MSGQ module and not by user applications. A simple static allocator called STATICPOOL is provided with DSP/BIOS, but other allocators can be implemented by following the standard interface.

Note: This document does not discuss how to write an allocator. Information about designing allocators and transports will be provided in a future document.

An application can use multiple allocators. The purpose of having multiple allocators is to allow an application to regulate its message usage. For example, an application can allocate critical messages from one pool of fast on-chip memory and non-critical messages from another pool of slower external memory.

6.5.4 Transports

The job of the transport is to communicate across a physical link to another processor. The transport interface allows you to change the underlying communication mechanism without changing the application (except for the configuration of the transport).

A transport is an instance of an implementation of the transport interface. There is an array of transports on each processor. There is at most one transport between any two processors. This array is based on processor IDs. So the first element (the 0th index) of the transport array on each processor contains the transport to processor 0. On processor 0, the first element is a MSGQ_NOTTRANSPORT transport that is never used.

For example, consider the system shown in the following figure, in which three processors are running DSP/BIOS. The transports are indicated by the arrows.

Figure 6–6 Transports in a Multi-Processor Example

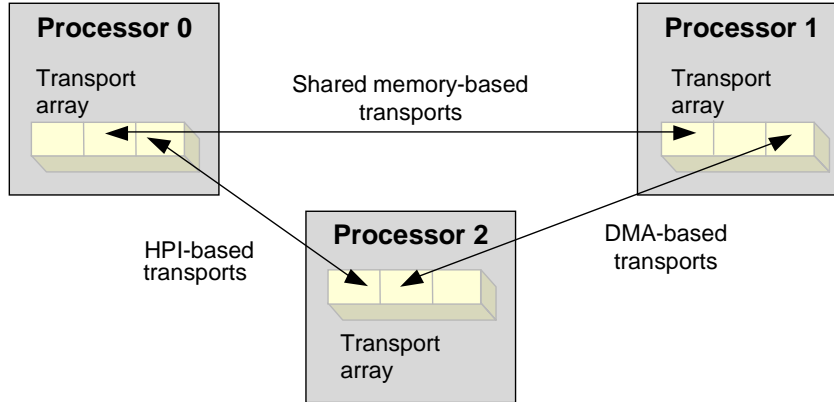

Since there are three processors in the system, there must be an array of three transports on each processor.

Processor	Transport Array
Processor 0	[0]: MSGQ_NOTTRANSPORT transport [1]: transport to processor 1 based on shared memory [2]: transport to processor 2 based on HPI
Processor 1	[0]: transport to processor 0 based on shared memory [1]: MSGQ_NOTTRANSPORT transport [2]: transport to processor 2 based on DMA
Processor 2	[0]: transport to processor 0 based on HPI [1]: transport to processor 1 based on DMA [2]: MSGQ_NOTTRANSPORT transport

This example uses MSGQ_NOTTRANSPORT for the array locations that correspond to the current processor. In addition, if two separate processors do not communicate in your system, you must use the MSGQ_NOTTRANSPORT in the appropriate locations in the transport arrays.

The MSGQ module describes the standard interface functions that transports must provide. The transport interface functions are called by the MSGQ functions and not by user applications.

Note: This document does not discuss how to write a transport. Information about designing allocators and transports will be provided in a future document.

The protocol between transports is transport-specific, but must have the ability to locate message queues and send messages across the physical boundary. The following figure shows an example of sending a message to a message queue on another processor.

Figure 6–7 Remote Transport

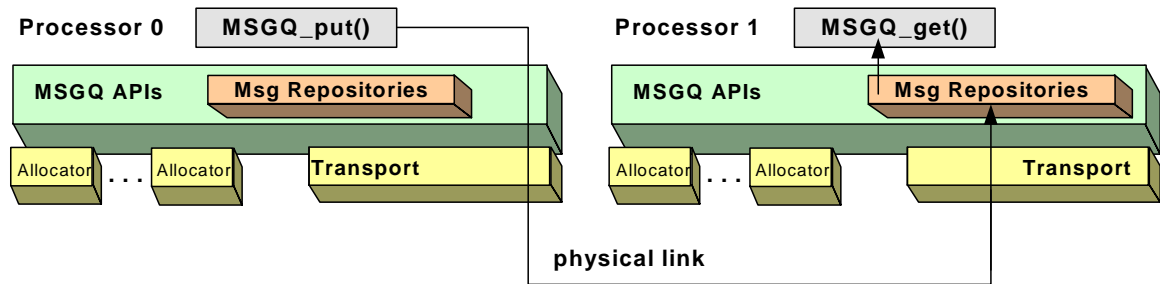

6.5.5 Multi-Processor Issues

One of the key features of the MSGQ module is transparency in a multi-processor environment. Moving a reader from one processor to another causes no change in the writer code. Similarly, moving a writer to another processor causes no change in the reader.

On each processor, there is one transport for each of the other processors. For instance, in a system that has four processors that communicate with each other, each processor must have three transports (one to talk to each of the other three processors) and one `MSGQ_NOTTRANSPORT` transport. If two processors have more than one physical link between them (for example, shared memory and serial), it is up to the transport to manage the two links (for example, to determine which messages go on which link)

When a message is allocated, the ID of the allocator is embedded into the `MSGQ_MsgHeader` portion of the allocated message. This makes it easy to free the message later. That is, the application does not need to remember which allocator was used to allocate the message.

Some transports are copy-based. When such transports send a message to a remote processor, the message is copied to the physical link (for example, TCP/IP). In the case of a copy-based transport, the transport on the source processor frees the message after it is copied. The transport on the destination processor allocates a message and sends it to the destination message queue. All the transport's allocations and frees are transparent to the application. The reader thread is still responsible for freeing or re-using the received message.

The following figure shows the sequence of events that occur when sending a message to a remote processor via a copy-based transport. After these events, the message can be received via a `MSGQ_get` on the remote processor.

Figure 6–8 Events on Sending Message to Remote Processor

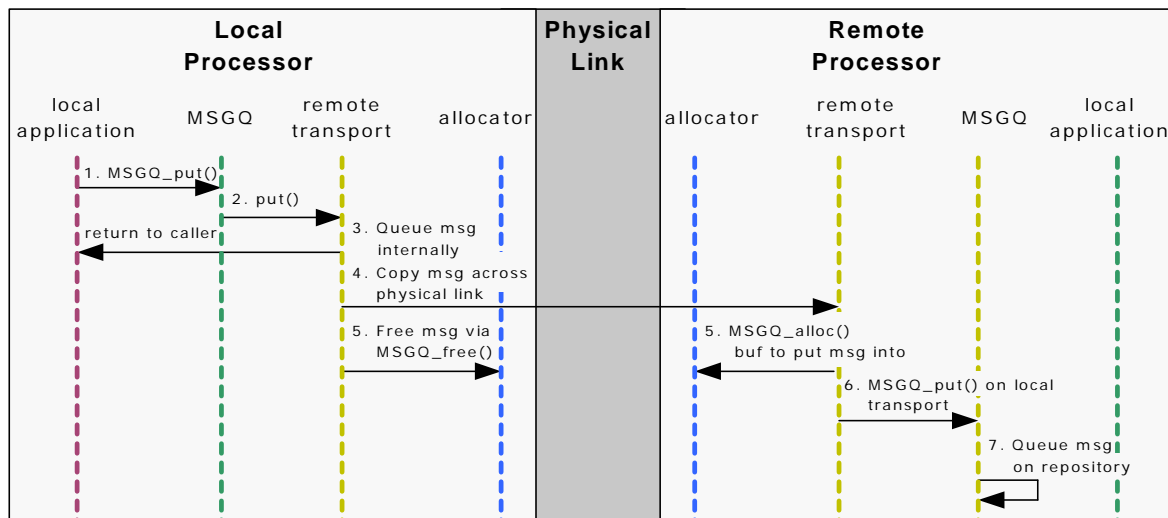

For transports that are zero-copy based (for example, using shared memory), the transport simply signals the other side that a message is present. There are no intermediate allocations or frees in this case. The reader is still responsible for freeing or re-using the received message.

In either type of transport, the allocator configuration must be the same on different processors. Take the following two examples:

- **Zero-copy based remote transport.** If allocator 0 is a shared memory allocator on processor A, then allocator 0 on processor B must act on that same shared memory.
- **Copy based remote transport.** If allocator 1 allocates messages of size 64 bytes, then allocator 1 on processor B must also allocate messages of 64 bytes (if messages are flowing in both directions). The underlying allocation mechanisms may be different, but the sizes of the messages must be the same.

Routing is the ability to send a message from one processor to another processor via an intermediate processor. Routing is needed when there is no physical link between two processors. Routing is not directly supported by the MSGQ module. Routing can be built on top of the MSGQ module, but must be managed at the application level. For example, you might create a thread that acts as a router.

Neither MSGQ nor the transport perform an endian conversion on the user portion of a message. The transport performs necessary endian conversion on the MSGQ_MsgHeader portion of the message, but not on the rest of the message. It is up to the application to manage endian conversion of the remainder of the message.

6.5.6 Data Transfer Module Comparison

There are several modules available in DSP/BIOS for data movement:

- MBX. Mailbox module.
- MSGQ. Message queue module
- PIP. Pipe module.
- QUE. Queue module

- SIO. Streaming I/O module.

Both SIO and PIP use a streaming model. Here are the differences between streaming and messaging from a DSP/BIOS perspective:

- A *stream* is a continuous sequence of real-time data. Streaming is point-to-point: one writer and one reader. It typically is performed with zero copying.
- A *message* is an asynchronous piece of control information. Messaging is generally performed with multiple writers and one reader.

There are several differences between MSGQ, QUE, and MBX. Each module has its pros and cons. Ultimately, it is up to the application designer to decide which one fits their application best. The following list describes issues to consider when making a decision:

- **Multi-Processor Support.** MSGQ offers multi-processor support. Neither QUE nor MBX does.
- **Message Ownership.** Once a message is sent by MSGQ_put or QUE_put, ownership of the message is relinquished. The reader gets ownership once the message is received. In the MBX module, once a message is sent by MBX_post, the message is copied internally in MBX before the call returns. So once the MBX_post returns, the sender still controls the buffer.
- **Message Copying.** The MBX module is copy based. QUE is zero-copy. For MSGQ, intra-processor transfers are zero-copy actions. An inter-processor transfer may or may not be copy based (depends on the transport).
- **Notification Mechanisms.** Both MSGQ and MBX offer notification mechanisms. So the reader can block while waiting for a message. Additionally, MSGQ allows user specified notification mechanisms (instead of always a semaphore in MBX). So the notification could be the posting of a SWI. QUE has no type of notification mechanism. It is up to the application to handle this—for example, by polling or by using semaphores in the application.
- **Message Size and Number.** The MBX module has a fixed length and number of messages per mailbox. These values are specified when the mailbox is created. Both QUE and MSGQ allow for variable sized messages. They have no maximum number of messages that may be waiting to be received.
- **Complexity and Footprint.** The MSGQ module offers many advanced features. However, this comes with added complexity and a larger footprint. For applications that do not need these advanced features and flexibility, the QUE or MBX modules might be a better solution because of lower footprint and easier use.

6.6 Host Channel Manager (HST Module)

The HST module manages host channel objects, which allow an application to stream data between the target and the host. Host channels are configured for input or output. Input streams read data from the host to the target. Output streams transfer data from the target to the host.

Note: HST channel names cannot start with a leading underscore (_).

Each host channel is internally implemented using a pipe object. To use a particular host channel, the program uses HST_getpipe to get the corresponding pipe object and then transfers data by calling the PIP_get and PIP_free operations (for input) or PIP_alloc and PIP_put operations (for output).

The code for reading data might look like Example 6-5.

Example 6-5 Reading Data Through a Host Channel

```

extern far HST_Obj input;

readFromHost()
{
    PIP_Obj *pipe;
    Uns size;
    Ptr addr;

    pipe = HST_getpipe(&input)    /* get a pointer to the host
                                channel's pipe object */
    PIP_get(pipe);               /* get a full frame from the
                                host */

    size = PIP_getReaderSize(pipe);
    addr = PIP_getReaderAddr(pipe);

    ' read data from frame '

    PIP_free(pipe);             /* release empty frame to the host */
}

```

Each host channel can specify a data notification function to be performed when a frame of data for an input channel (or free space for an output channel) is available. This function is triggered when the host writes or reads a frame of data.

HST channels treat files as 16- or 32-bit words of raw data, depending on the platform. The format of the data is application-specific, and you should verify that the host and the target agree on the data format and ordering. For example, if you are reading 32-bit integers from the host, you need to make sure the host file contains the data in the correct byte order. Other than correct byte order, there are no special format or data type requirements for data to be transferred between the host and the target.

While you are developing a program, you can use HST objects to simulate data flow and to test changes made to canned data by program algorithms. During early development, especially when testing signal processing algorithms, the program would explicitly use input channels to access data sets from a file for input for the algorithm and would use output channels to record algorithm output. The data saved to a file with the output host channel can be compared with expected results to detect algorithm errors. Later in the program development cycle, when the algorithm appears sound, you can change the HST objects to PIP objects communicating with other threads or I/O drivers for production hardware.

6.6.1 Transfer of HST Data to the Host

While the amount of usable bandwidth for real-time transfer of data streams to the host ultimately depends on the choice of physical data link, the HST Channel interface remains independent of the physical link. The HST Manager in the configuration allows you to choose among the physical connections available.

On the C55x and C6000 platforms, the host PC triggers an interrupt to transfer data to and from the target. This interrupt has a higher priority than SWI, TSK, and IDL functions. The actual ISR function runs in a very short time. Within the idle loop, the LNK_dataPump function does the more time-consuming work of preparing the RTDX buffers and performing the RTDX calls. Only the actual data transfer is done at high priority. This data transfer can have a small effect on real-time behavior, particularly if a large amount of LOG data must be transferred.

6.7 I/O Performance Issues

If you are using an HST object, the host PC reads or writes data using the function specified by the LNK_dataPump object. This is a built-in IDL object that runs its function as part of the background thread. On the C55x and C6000 platforms, the actual data transfer occurs at high priority.

The polling rates you set in the LOG, STS, and TRC controls do not control the data transfer rate for HST objects. Faster polling rates actually slow the data transfer rate somewhat because LOG, STS, and TRC data also need to be transferred.

Streaming I/O and Device Drivers

This chapter describes issues relating to writing and using device drivers that use the DEV_Fxns model, and gives several programming examples.

Topic	Page
7.1 Overview of Streaming I/O and Device Drivers	180
7.2 Creating and Deleting Streams	182
7.3 Stream I/O—Reading and Writing Streams	183
7.4 Stackable Devices	192
7.5 Controlling Streams	196
7.6 Selecting Among Multiple Streams	197
7.7 Streaming Data to Multiple Clients	198
7.8 Streaming Data Between Target and Host	199
7.9 Device Driver Template	200
7.10 Streaming DEV Structures	201
7.11 Device Driver Initialization	203
7.12 Opening Devices	203
7.13 Real-Time I/O	206
7.14 Closing Devices	209
7.15 Device Control	210
7.16 Device Ready	211
7.17 Types of Devices	213

7.1 Overview of Streaming I/O and Device Drivers

Note: This chapter describes devices that use the DEV_Fxns function table type. The *DSP/BIOS Driver Developer's Guide* (SPRU616) describes a newer device driver model—the IOM model, which uses a function table of type IOM_Fxns. See that document for a description of how to create IOM mini-drivers and how to integrate IOM mini-drivers into your applications.

The information in this chapter related to using SIO streams is still relevant if you are using SIO streams with IOM mini-drivers.

Chapter 6 describes the device-independent I/O operations supported by DSP/BIOS from the vantage point of an application program. Programs indirectly invoke corresponding functions implemented by the driver managing the particular physical device attached to the stream, using generic functions provided by the SIO module. As shown in the shaded portion of Figure 7–1, this chapter describes device-independent I/O in DSP/BIOS from the driver's perspective of this interface.

Figure 7–1 Device-Independent I/O in DSP/BIOS

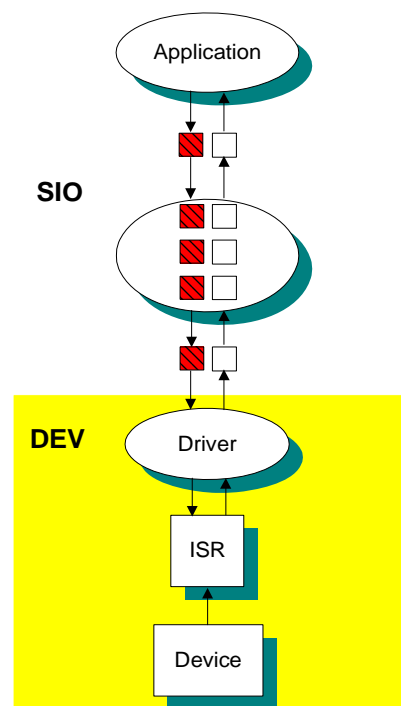

Unlike other modules, your application programs do not issue direct calls to driver functions that manipulate individual device objects managed by the SIO module. Instead, each driver module exports a specifically named structure of a specific type (DEV_Fxns), which in turn is used by the SIO module to route generic function calls to the proper driver function.

As illustrated in Table 7–1, each SIO operation calls the appropriate driver function by referencing this table. Dxx designates the device-specific function which you write for your particular device.

Table 7–1. Generic I/O to Internal Driver Operations

Generic I/O Operation	Internal Driver Operation
SIO_create(name, mode, bufsize, attrs)	Dxx_open(device, name)
SIO_delete(stream)	Dxx_close(device)
SIO_get(stream, &buf)	Dxx_issue(device) and Dxx_reclaim(device)
SIO_put(stream, &buf, nbytes)	Dxx_issue(device) and Dxx_reclaim(device)
SIO_ctrl(stream, cmd, arg)	Dxx_ctrl(device, cmd, arg)
SIO_idle(stream)	Dxx_idle(device, FALSE)
SIO_flush(stream)	Dxx_idle(device, TRUE)
SIO_select(streamtab, n, timeout)	Dxx_ready(device, sem)
SIO_issue(stream, buf, nbytes, arg)	Dxx_issue(device)
SIO_reclaim(stream, &buf, &arg)	Dxx_reclaim(device)
SIO_staticbuf(stream, &buf)	none

These internal driver functions can rely on virtually all of the capabilities supplied by DSP/BIOS, ranging from the multitasking features of the kernel to the application-level services. Drivers use the device-independent I/O interface of DSP/BIOS to communicate indirectly with other drivers, especially in supporting stackable devices.

Figure 7–2 illustrates the relationship between the device, the Dxx device driver, and the stream accepting data from the device. SIO calls the Dxx functions listed in DEV_Fxns, the function table for the device. Both input and output streams exchange buffers with the device using the atomic queues device→todevice and device→fromdevice.

Figure 7–2 Device, Driver, and Stream Relationship

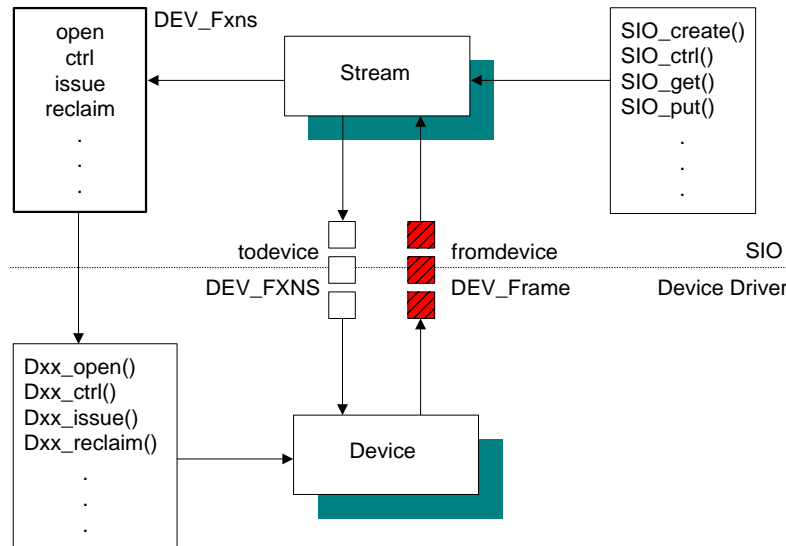

For every device driver you need to write Dxx_open, Dxx_idle, Dxx_input, Dxx_output, Dxx_close, Dxx_ctrl, Dxx_ready, Dxx_issue, and Dxx_reclaim.

7.2 Creating and Deleting Streams

To enable your application to do streaming I/O with a device, the device must first be added to the configuration. You can add a device for any driver included in the product distribution or a user-supplied driver. To use a stream to perform I/O with a device, first configure the device. Then, create the stream object in the configuration or at runtime with the SIO_create function.

7.2.1 Creating Streams Staticly

In the configuration, you can create streams and set the properties for each stream and for the SIO Manager itself. You cannot use the SIO_delete function to delete statically-created streams.

7.2.2 Creating and Deleting Streams Dynamically

You can also create a stream at run time with the SIO_create function as shown in Example 7-1.

Example 7-1 Creating a Stream with SIO_create

```
SIO_Handle SIO_create(name, mode, bufsize, attrs)
    String      name;
    Int         mode;
    Uns        bufsize;
    SIO_Attrs   *attrs;
```

SIO_create creates a stream and returns a handle of type SIO_Handle. SIO_create opens the device(s) specified by name, specifying buffers of size bufsize. Optional attributes specify the number of buffers, the buffer memory segment, the streaming model, etc. The mode parameter is used to specify whether the stream is an input (SIO_INPUT) or output (SIO_OUTPUT) stream.

Note: The parameter name must be the same as the name configured for the device but preceded by a slash character (/). For example, for a device called sine, name should be “/sine.”

If you open the stream with the streaming model (attrs→model) set to SIO_STANDARD (the default), buffers of the specified size are allocated and used to prime the stream. If you open the stream with the streaming model set to SIO_ISSUERECLAIM, no stream buffers are allocated, since the creator of the stream is expected to supply all necessary buffers.

SIO_delete, shown in Example 7-2, closes the associated device(s) and frees the stream object. If the stream was opened using the SIO_STANDARD streaming model, it also frees all buffers remaining in the stream. User-held stream buffers must be explicitly freed by the user’s code.

Example 7-2 Freeing User-Held Stream Buffers

```
Int SIO_delete(stream)
    SIO_Handle   stream;
```

7.3 Stream I/O—Reading and Writing Streams

There are two models for streaming data in DSP/BIOS: the standard model and the Issue/Reclaim model. The standard model provides a simple method for using streams, while the Issue/Reclaim model provides more control over the stream operation.

SIO_get and SIO_put implement the standard stream model as shown in Example 7-3. SIO_get is used to input the data buffers. SIO_get exchanges buffers with the stream. The bufp parameter is used to pass the device a buffer and return a different buffer to the application. SIO_get returns the number of bytes in the input buffer. The SIO_put function performs the output of data buffers, and, like SIO_get, exchanges physical buffers with the stream. SIO_put takes the number of bytes in the output buffer

Example 7-3 Inputting and Outputting Data Buffers

```

Int SIO_get(stream, bufp)
    SIO_Handle    stream;
    Ptr           *bufp;

Int SIO_put(stream, bufp, nbytes)
    SIO_Handle    stream;
    Ptr           *bufp;
    Uns          nbytes;
  
```

Note: Since the buffer pointed to by `bufp` is exchanged with the stream, the buffer size, memory segment, and alignment must correspond to the attributes of stream.

`SIO_issue` and `SIO_reclaim` are the calls that implement the Issue/Reclaim streaming model as shown in Example 7-4. `SIO_issue` sends a buffer to a stream. No buffer is returned, and the stream returns control to the task without blocking. `arg` is not interpreted by DSP/BIOS, but is offered as a service to the stream client. `arg` is passed to each device with the associated buffer data. It can be used by the stream client as a method of communicating with the device drivers. For example, `arg` could be used to send a time stamp to an output device, indicating exactly when the data is to be rendered. `SIO_reclaim` requests a stream to return a buffer.

Example 7-4 Implementing the Issue/Reclaim Streaming Model

```

Int SIO_issue(stream, pbuf, nbytes, arg)
    SIO_Handle    stream;
    Ptr           pbuf;
    Uns          nbytes;
    Arg          arg;

Int SIO_reclaim(stream, bufp, parg)
    SIO_Handle    stream;
    Ptr           *bufp;
    Arg          *parg;
  
```

If no buffer is available, the stream will block the task until the buffer becomes available or the stream's timeout has elapsed.

At a basic level, the most obvious difference between the standard and Issue/Reclaim models is that the Issue/Reclaim model separates the notification of a buffer's arrival (`SIO_issue`) and the waiting for a buffer to become available (`SIO_reclaim`). So, an `SIO_issue/SIO_reclaim` pair provides the same buffer exchange as calling `SIO_get` or `SIO_put`.

The Issue/Reclaim streaming model provides greater flexibility by allowing the stream client to control the number of outstanding buffers at runtime. A client can send multiple buffers to a stream, without blocking, by using `SIO_issue`. The buffers are returned, at the client's request, by calling `SIO_reclaim`. This allows the client to choose how deep to buffer a device and when to block and wait for a buffer.

The Issue/Reclaim streaming model also provides greater determinism in buffer management by guaranteeing that the client's buffers are returned in the order that they were issued. This allows a client to use memory from any source for streaming. For example, if a DSP/BIOS task receives a large buffer,

that task can pass the buffer to the stream in small pieces—simply by advancing a pointer through the larger buffer and calling SIO_issue for each piece. This works because each piece of the buffer is guaranteed to come back in the same order it was sent.

7.3.1 Buffer Exchange

An important part of the streaming model in DSP/BIOS is buffer exchange. To provide efficient I/O operations with a low amount of overhead, DSP/BIOS avoids copying data from one place to another during certain I/O operations. Instead, DSP/BIOS uses SIO_get, SIO_put, SIO_issue, and SIO_reclaim to move buffer pointers to and from the device. Figure 7–3 shows a conceptual view of how SIO_get works.

Figure 7–3 How SIO_get Works

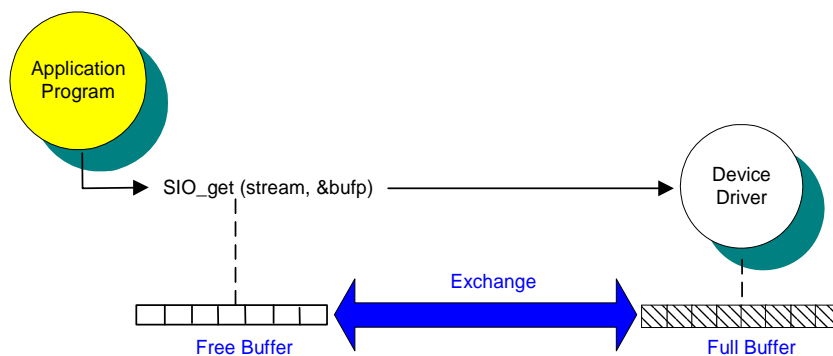

In Figure 7–3, the device driver associated with stream fills a buffer as data becomes available. At the same time, the application program is processing the current buffer. When the application uses SIO_get to get the next buffer, the new buffer that was filled by the input device is swapped for the buffer passed in. This is accomplished by exchanging buffer pointers instead of copying bufsize bytes of data, which would be very time consuming. Therefore, the overhead of SIO_get is independent of the buffer size.

In each case, the actual physical buffer has been changed by SIO_get. The important implication is that you must make sure that any references to the buffer used in I/O are updated after each operation. Otherwise, you are referencing an invalid buffer.

SIO_put uses the same exchange of pointers to swap buffers for an output stream. SIO_issue and SIO_reclaim each move data in only one direction. Therefore, an SIO_issue/SIO_reclaim pair result in the same swapping of buffer pointers.

Note: A single stream cannot be used by more than one task simultaneously. That is, only a single task can call SIO_get/SIO_put or SIO_issue/SIO_reclaim at once for each stream in your application.

7.3.2 Example - Reading Input Buffers from a DGN Device

The program in Example 7-5 illustrates some of the basic SIO functions and provides a straightforward example of reading from a stream. For a complete description of the DGN software generator driver, see the DGN section in the *TMS320 DSP/BIOS API Reference Guide* for your platform.

The configuration template for Example 7-5 can be found in the `siotest` directory of the DSP/BIOS distribution. A DGN device called `sineWave` is used as a data generator to the SIO stream `inputStream`. The task `streamTask` calls the function `doStreaming` to read the sine data from the `inputStream` and prints it to the log buffer trace. The output for Example 7-5 appears as sine wave data in Figure 7-4.

Example 7-5 Basic SIO Functions

```

/*
 * ===== siotest1.c =====
 * In this program a task reads data from a DGN sine device
 * and prints the contents of the data buffers to a log buffer.
 * The data exchange between the task and the device is done
 * in a device independent fashion using the SIO module APIs.
 *
 * The stream in this example follows the SIO_STANDARD streaming
 * model and is created statically.
 */

#include <std.h>

#include <log.h>
#include <sio.h>
#include <sys.h>
#include <tsk.h>

extern Int IDRAM1; /* MEM segment ID defined by Conf tool */
extern LOG_Obj trace; /* LOG object created with Conf tool */
extern SIO_Obj inputStream; /* SIO object created w Conf tool */
extern TSK_Obj streamTask; /* pre-created task */

SIO_Handle input = &inputStream; /* SIO handle used below */

Void doStreaming(Uns nloops); /* function for streamTask */

/*
 * ===== main =====
 */
Void main()
{
    LOG_printf(&trace, "Start SIO example #1");
}
    
```

Example 7.5 Basic SIO Function (continued)

```

* ===== doStreaming =====
* This function is the body of the pre-created TSK thread
* streamTask.
*/
Void doStreaming(Uns nloops)
{
    Int i, j, nbytes;
    Int *buf;
    status = SIO_staticbuf(input, (Ptr *)&buf);
    if (status != SYS ok) {
        SYS_abort("could not acquire static frame:");
    }

    for (i = 0; i < nloops; i++) {
        if ((nbytes = SIO_get(input, (Ptr *)&buf)) < 0) {
            SYS_abort("Error reading buffer %d", i);
        }

        LOG_printf(&trace, "Read %d bytes\nBuffer %d data:",
nbytes, i);
        for (j = 0; j < nbytes / sizeof(Int); j++) {
            LOG_printf(&trace, "%d", buf[j]);
        }
    }

    LOG_printf(&trace, "End SIO example #1");
}

```

Figure 7–4 Output Trace for Example 7-5

```

Log Name: trace
0 Start SIO example #1
1 Read 128 bytes
Buffer 0 data:
2 0
3 48
4 90
5 118
6 127
7 118
8 90
9 48
10 0
11 -49
12 -91
13 -119
14 -128
15 -119
16 -91
17 -49
18 0
19 48
20 90
21 118
22 127
23 118
24 90
25 48
26 0
27 -49
28 -91
29 -119
30 -128
31 -119
32 -91
33 -49
    
```

7.3.3 Example - Reading and Writing to a DGN Device

Example 7-6 adds new SIO operations to the previous one. An output stream, `outputStream`, has been added to the configuration. `streamTask` reads buffers from a DGN sine device as before, but now it sends the data buffers to `outputStream` rather than printing the contents to a log buffer. The stream `outputStream` sends the data to a DGN user device called `printData`. Device `printData` takes the data buffers received and uses the `DGN_print2log` function to display their contents in a log buffer. The log buffer is specified by the user in the configuration.

Example 7-6 Adding an Output Stream to Example 7-5

```

===== Portion of siotest2.c =====
/* SIO objects created with conf tool */
extern far LOG_Obj trace;
extern far SIO_Obj inputStream;
extern far SIO_Obj outputStream;
extern far TSK_Obj streamTask;
SIO_Handle input = &inputStream;
SIO_Handle output = &outputStream;
...

Void doStreaming(Uns nloops)
{
Void doStreaming(Arg nloops_arg)
{
    Int i, nbytes;
    Int *buf;
    Long nloops = (Long) nloops_arg;
    if ( SIO_staticbuf(input, (Ptr *)&buf) == 0) {
        SYS_abort("Error reading buffer ");
    }

    for (i = 0; i < nloops; i++) {
        if ((nbytes = SIO_get(input, (Ptr *)&buf)) < 0) {
            SYS_abort("Error reading buffer %d", (Arg)i);
        }
        if (SIO_put(output, (Ptr *)&buf, nbytes) < 0) {
            SYS_abort("Error writing buffer %d", (Arg)i);
        }
    }
    LOG_printf(&trace, "End SIO example #2");
}
/* ===== DGN_print2log =====
* User function for the DGN user device printData. It takes as an argument
* the address of the LOG object where the data stream should be printed. */

Void DGN_print2log(Arg arg, Ptr addr, Uns nbytes)
{
    Int    i;
    Int    *buf;
    buf = (Int *)addr;

    for (i = 0; i < nbytes/sizeof(Int); i++) {
        LOG_printf((LOG_Obj *)arg, "%d", buf[i]);
    }
}

```



Non-pointer type function arguments to LOG_printf() need explicit type casting to (Arg) as shown in the following code example:

```
LOG_printf(&trace, "Task %d Done", (Arg) id);
```

For more details on how to add and configure a DGN device statically, see the DGN section in the *TMS320 DSP/BIOS API Reference Guide* for your platform.

In the output for this example, sine wave data is as follows.

Figure 7–5 Results for Example 7-6.

```

0 0
1 48
2 90
3 118
4 127
5 118
6 90
7 48
8 0
9 -49
10 -91
11 -119
12 -128
13 -119
14 -91
15 -49
16 0
17 48
18 90
19 118
20 127
21 118
22 90
23 48
24 0
    
```

7.3.4 Example - Stream I/O using the Issue/Reclaim Model

Example 7-7 is functionally equivalent to Example 7-6. However, the streams are now created using the Issue/Reclaim model, and the SIO operations to read and write data to a stream are SIO_issue and SIO_reclaim.

In this model, when streams are created dynamically, no buffers are initially allocated so the application must allocate the necessary buffers and provide them to the streams to be used for data I/O. For static streams, you can allocate static buffers in the configuration by checking the Allocate Static Buffer(s) check box for the SIO object.

Example 7-7 Using the Issue/Reclaim Model

```

/* ===== doIRstreaming ===== */
Void doIRstreaming(Uns nloops)
{
    Ptr    buf;
    Arg    arg;
    Int    i, nbytes;

    /* Prime the stream with a couple of buffers */
    buf = MEM_alloc(IDRAM1, SIO_bufsize(input), 0);
    if (buf == MEM_ILLEGAL) {
        SYS_abort("Memory allocation error");
    }
    /* Issue an empty buffer to the input stream */
    if (SIO_issue(input, buf, SIO_bufsize(input), NULL) < 0) {
        SYS_abort("Error issuing buffer %d", i);
    }

    buf = MEM_alloc(IDRAM1, SIO_bufsize(input), 0);
    if (buf == MEM_ILLEGAL) {
        SYS_abort("Memory allocation error");
    }

    for (i = 0; i < nloops; i++) {
        /* Issue an empty buffer to the input stream */
        if (SIO_issue(input, buf, SIO_bufsize(input), NULL) < 0) {
            SYS_abort("Error issuing buffer %d", i);
        }
        /* Reclaim full buffer from the input stream */
        if ((nbytes = SIO_reclaim(input, &buf, &arg)) < 0) {
            SYS_abort("Error reclaiming buffer %d", i);
        }
        /* Issue full buffer to the output stream */
        if (SIO_issue(output, buf, nbytes, NULL) < 0) {
            SYS_abort("Error issuing buffer %d", i);
        }
        /* Reclaim empty buffer from the output stream to be reused */
        if (SIO_reclaim(output, &buf, &arg) < 0) {
            SYS_abort("Error reclaiming buffer %d", i);
        }
    }
    /* Reclaim and delete the buffers used */
    MEM_free(IDRAM1, buf, SIO_bufsize(input));
    if ((nbytes = SIO_reclaim(input, &buf, &arg)) < 0) {
        SYS_abort("Error reclaiming buffer %d", i);
    }
    if (SIO_issue(output, buf, nbytes, NULL) < 0) {
        SYS_abort("Error issuing buffer %d", i);
    }
    if (SIO_reclaim(output, &buf, &arg) < 0) {
        SYS_abort("Error reclaiming buffer %d", i);
    }

    MEM_free(IDRAM1, buf, SIO_bufsize(input));
}

```

The output for Example 7-7 is the same as found in Example 7-5.

7.4 Stackable Devices

The capabilities of the SIO module play an important role in fostering device-independence within DSP/BIOS in that logical devices insulate your application programs from the details of designating a particular device. For example, `/dac` is a logical device name that does not imply any particular DAC hardware. The device-naming convention adds another dimension to device-independent I/O that is unique to DSP/BIOS—the ability to use a single name to denote a stack of devices.

Note: By stacking certain data streaming or message passing devices atop one another, you can create virtual I/O devices that further insulate your applications from the underlying system hardware.

Consider, as an example, a program implementing an algorithm that inputs and outputs a stream of fixed-point data using a pair of A/D-D/A converters. However, the A/D-D/A device can take only the 14 most significant bits of data, and the other two bits have to be 0 if you want to scale up the input data.

Instead of cluttering the program with excess code for data conversion and buffering to satisfy the algorithm's needs, we can open a pair of virtual devices that implicitly perform a series of transformations on the data produced and consumed by the underlying real devices as shown in Example 7-8.

Example 7-8 Opening a Pair of Virtual Devices

```

SIO_Handle input;
SIO_Handle output;
Ptr      buf;
Int      n;

buf = MEM_alloc(0, MAXSIZE, 0);

input = SIO_create("/scale2/a2d", SIO_INPUT, MAXSIZE, NULL);
output = SIO_create("/mask2/d2a", SIO_OUTPUT, MAXSIZE, NULL);

while (n = SIO_get(input, &buf)) {
    `apply algorithm to contents of buf`
    SIO_put(output, &buf, n);
}

SIO_delete(input);
SIO_delete(output);

```

In Example 7-8, the virtual input device, `/scale2/a2d`, actually comprises a stack of two devices, each named according to the prefix of the device name specified in your configuration file.

- **/scale2** designates a device that transforms a fixed-point data stream produced by an underlying device (`/a2d`) into a stream of scaled fixed-point values; and
- **/a2d** designates a device managed by the A/D-D/A device driver that produces a stream of fixed-point input from an A/D converter.

The virtual output device, `/mask2/d2a`, likewise denotes a stack of two devices. Figure 7–6 shows the flow of empty and full frames through these virtual source and sink devices as the application program calls the SIO data streaming functions.

Figure 7–6 The Flow of Empty and Full Frames

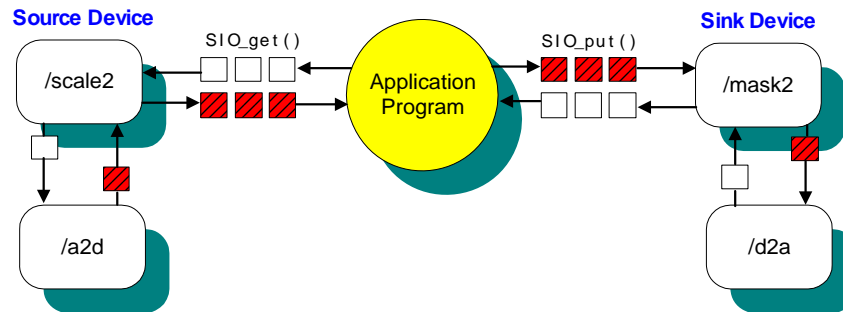

7.4.1 Example - SIO_create and Stacking Devices

Example 7-9, illustrates two tasks, sourceTask and sinkTask, that exchange data through a pipe device.

sourceTask is a writer task that receives data from an input stream attached to a DGN sine device and redirects the data to an output stream attached to a DPI pipe device. The input stream also has a stacking device, scale, on top of the DGN sine device. The data stream coming from sine is first processed by the scale device (that multiplies each data point by a constant integer value), before it is received by sourceTask.

sinkTask is a reader task that reads the data that sourceTask sent to the DPI pipe device through an input stream, and redirects it to a DGN printData device through an output stream.

The devices in Example 7-9 have been configured statically. The devices sineWave and printDat are DGN devices. pip0 is a DPI device. scale is a DTR stacking device. For more information on how to add and configure DPI, DGN, and DTR devices, see the DPI, DGN and DTR drivers description in the *TMS320 DSP/BIOS API Reference Guide* for your platform.

The streams in Example 7-9 have also been added to the configuration. The input stream for the sourceTask task is inStreamSrc.

When you configure an SIO stream that uses a stacking device, you must first enter a configured terminal device in the Device Control Parameter property. The name of the terminal device must be preceded by a slash character (/). In the example we use /sineWave, where sineWave is the name of a configured DGN terminal device. Then select the stacking device (scale) from the dropdown list in the Device property. The configuration will not allow you to select a stacking device in Device until a terminal device has been entered in Device Control Parameter. The other SIO streams created for Example 7-9 are outStreamSrc (output stream for sourceTask), inStreamSink (input stream for sinkTask), and outStreamSink (output stream for sinkTask). The devices used by these streams are the terminal devices pip0 and printData.

Example 7-9 Data Exchange Through a Pipe Device

```

/*
 * ===== siotest5.c =====
 * In this program two tasks are created that exchange data
 * through a pipe device. The source task reads sine wave data
 * from a DGN device through a DTR device stacked on the sine
 * device, and then writes it to a pipe device. The sink task
 * reads the data from the pipe device and writes it to the
 * printData DGN device. The data exchange between the tasks
 * and the devices is done in a device independent fashion
 * using the SIO module APIs.
 *
 * The streams in this example follow the SIO_STANDARD streaming
 * model and are created statically.
 */

#include <std.h>

#include <dtr.h>
#include <log.h>
#include <mem.h>
#include <sio.h>
#include <sys.h>
#include <tsk.h>

#define BUFSIZE 128

#ifdef _62
#define SegId IDRAM
extern Int IDRAM; /* MEM segment ID defined with conf tool */
#endif

#ifdef _55
#define SegId DATA
extern Int DATA; /* MEM segment ID defined with conf tool */
#endif

extern LOG_Obj trace; /* LOG object created with conf tool */
extern TSK_Obj sourceTask; /* TSK thread objects created via conf tool */
extern TSK_Obj sinkTask;
extern SIO_Obj inStreamSrc; /* SIO streams created via conf tool */
extern SIO_Obj outStreamSrc;
extern SIO_Obj inStreamSink;
extern SIO_Obj outStreamSink;

/* Parameters for the stacking device "/scale" */
DTR_Params DTR_PRMS = {
    20, /* Scaling factor */
    NULL,
    NULL
};

Void source(Uns nloops); /* function body for sourceTask above */
Void sink(Uns nloops); /* function body for sinkTask above */

static Void doStreaming(SIO_Handle input, SIO_Handle output, Uns nloops);

/*

```

Example 7.9 Data Exchange Through a Pipe Device (continued)

```

* ===== main =====
*/
Void main()
{
    LOG_printf(&trace, "Start SIO example #5");
}

/*
* ===== source =====
* This function forms the body of the sourceTask TSK thread.
*/
Void source(Uns nloops)
{
    SIO_Handle input = &inStreamSrc;
    SIO_Handle output = &outStreamSrc;

    /* Do I/O */
    doStreaming(input, output, nloops);
}

/*
* ===== sink =====
* This function forms the body of the sinkTask TSK thread.
*/
Void sink(Uns nloops)
{
    SIO_Handle input = &inStreamSink;
    SIO_Handle output = &outStreamSink;

    /* Do I/O */
    doStreaming(input, output, nloops);

    LOG_printf(&trace, "End SIO example #5");
}

/*
* ===== doStreaming =====
* I/O function for the sink and source tasks.
*/
static Void doStreaming(SIO_Handle input, SIO_Handle output, Uns nloops)
{
    Ptr    buf;
    Int    i, nbytes;

    if (SIO_staticbuf(input, &buf) == 0){
        SYS_abort("Error reading buffer %d", i);
    }
    for (i = 0; i < nloops; i++) {
        if ((nbytes = SIO_get (input, &buf)) <0) {
            SYS_abort ("Error reading buffer %d", i);
        }
        if (SIO_put (output, &buf, nbytes) <0) {
            SYS_abort ("Error writing buffer %d", i);
        }
    }
}

```

The output for Example 7-9 is scaled sine wave data as in Figure 7-7.

Figure 7–7 Sine Wave Output for Example 7-9

0	0
1	480
2	900
3	1180
4	1270
5	1180
6	900
7	480
8	0
9	-490
10	-910
11	-1190
12	-1280
13	-1190
14	-910
15	-490
16	0
17	480
18	900
19	1180
20	1270
21	1180
22	900
23	480
24	0

You can edit `sioTest5.c` and change the scaling factor of the `DTR_PRMS`, rebuild the executable and see the differences in the output to `myLog`.

A version of Example 7-9, where the streams are created dynamically at runtime by calling `SIO_create` is available in the product distribution (`sioTest4.c`, `sioTest4.cdb`).

7.5 Controlling Streams

A physical device typically requires one or more specialized control signals in order to operate as desired. `SIO_ctrl` makes it possible to communicate with the device, passing it commands and arguments. Since each device admits only specialized commands, you need to consult the documentation for each particular device. The general calling format is shown in Example 7-10.

Example 7-10 Using `SIO_ctrl` to Communicate with a Device

```

Int SIO_ctrl(stream, cmd, arg)
    SIO_Handle stream;
    Uns      cmd;
    Ptr      arg;
    
```

The device associated with `stream` is passed the command represented by the device-specific `cmd`. A generic pointer to the command's arguments is also passed to the device. The actual control function that is part of the device driver then interprets the command and arguments and acts accordingly.

Assume that an analog-to-digital converter device `/a2d` has a control operation to change the sample rate. The sample rate might be changed to 12 kHz as shown in Example 7-11.

Example 7-11 Changing Sample Rate

```
SIO_Handle    stream;

stream = SIO_create("/a2d", ...);

SIO_ctrl(stream, DAC_RATE, 12000);
```

In some situations, you can synchronize with an I/O device that is doing buffered I/O. There are two methods to synchronize with the devices: `SIO_idle` and `SIO_flush`. Either function leaves the device in the idled state. Idling a device means that all buffers are returned to the queues that they were in when the device was initially created. That is, the device is returned to its initial state, and streaming is stopped.

For an input stream, the two functions have the same results: all unread input is lost. For an output stream, `SIO_idle` blocks until all buffered data has been written to the device. However, `SIO_flush` discards any data that has not already been written. `SIO_flush` does not block as shown in Example 7-12.

Example 7-12 Synchronizing with a Device

```
Void SIO_idle(stream);
SIO_Handle    stream;
Void SIO_flush(stream);
SIO_Handle    stream;
```

An idle stream does not perform I/O with its underlying device. Thus, you can turn a stream off until further I/O is needed by calling `SIO_idle` or `SIO_flush`.

7.6 Selecting Among Multiple Streams

The `SIO_select` function allows a single DSP/BIOS task to wait until an I/O operation can be performed on one or more of a set of SIO streams without blocking. For example, this mechanism is useful in the following applications:

- **Non-blocking I/O.** Real-time tasks that stream data to a slow device (for example, a disk file) must ensure that `SIO_put` does not block.
- **Multitasking.** In virtually any multitasking application there are daemon tasks that route data from several sources. The `SIO_select` mechanism allows a single task to handle all of these sources.

`SIO_select` is called with an array of streams, an array length, and a time-out value. `SIO_select` blocks (if timeout is not 0) until one of the streams is ready for I/O or the time-out expires. In either case, the mask returned by `SIO_select` indicates which devices are ready for service (a 1 in bit `j` indicates that `streamtab[j]` is ready) as shown in Example 7-13.

Example 7-13 Indicating That a Stream is Ready

```
Uns SIO_select(streamtab, nstreams, timeout)
SIO_Handle    streamtab[];    /* stream table */
Uns          nstreams;       /* number of streams */
Uns          timeout;        /* return after this many */
                               /* system clock ticks */
```

7.6.1 Programming Example

In Example 7-14, two streams are polled to see if an I/O operation will block.

Example 7-14 Polling Two Streams

```

SIO_Handle    stream0;
SIO_Handle    stream1;
SIO_Handle    streamtab[2];
Uns          mask;

...

streamtab[0] = stream0;
streamtab[1] = stream1;

while ((mask = SIO_select(streamtab, 2, 0)) == 0) {
    `I/O would block, do something else`
}

if (mask & 0x1) {
    `service stream0`
}
if (mask & 0x2) {
    `service stream1`
}

```

7.7 Streaming Data to Multiple Clients

A common problem in multiprocessing systems is the simultaneous transmission of a single data buffer to multiple tasks in the system. Such multi-cast transmission, or scattering of data, can be done easily with DSP/BIOS SIO streams. Consider the situation in which a single processor sends data to four client processors.

Streaming data between processors in this context is somewhat different from streaming data to or from an acquisition device, such as an A/D converter, in that a single buffer of data must go to one or more clients. The DSP/BIOS SIO functions SIO_get/SIO_put are used for data I/O.

SIO_put automatically performs a buffer exchange between the buffer already at the device level and the application buffer. As a result, the user no longer has control over the buffer since it is enqueued for I/O, and this I/O happens asynchronously at the interrupt level. This forces the user to copy data in order to send it to multiple clients. This is shown in Example 7-15.

Example 7-15 Using SIO_put to Send Data to Multiple Clients

```

SIO_put(inStream, (Ptr)&bufA, npoints);

`fill bufA with data`
for (`all data points`) {
    bufB[i] = bufC[i] = bufD[i] ... = bufA[i];
}
SIO_put(outStreamA, (Ptr)&bufA, npoints);
SIO_put(outStreamB, (Ptr)&bufB, npoints);
SIO_put(outStreamC, (Ptr)&bufC, npoints);
SIO_put(outStreamD, (Ptr)&bufD, npoints);

```

Copying the data wastes CPU cycles and requires more memory, since each stream needs buffers. If you were double-buffering, Example 7-15 would require eight buffers (two for each stream).

Example 7-16, illustrates the advantage of SIO_issue and SIO_reclaim in this situation. The application performs no copying, and it uses only two buffers. In each call, SIO_issue simply enqueues the buffer pointed to by bufA onto outStream's todevice queue without blocking. Since there is no copying or blocking, this method greatly reduces the time between having a buffer of data ready for transmission and the time the buffer can be sent to all clients. In order to remove the buffers from the output devices, corresponding SIO_reclaim functions must be called.

Example 7-16 Using SIO_issue/SIO_reclaim to Send Data to Multiple Clients

```
SIO_issue(outStreamA, (Ptr)bufA, npoints, NULL);
SIO_issue(outStreamB, (Ptr)bufA, npoints, NULL);
SIO_issue(outStreamC, (Ptr)bufA, npoints, NULL);
SIO_issue(outStreamD, (Ptr)bufA, npoints, NULL);

SIO_reclaim(outStreamA, (Ptr)&bufA, NULL);
SIO_reclaim(outStreamB, (Ptr)&bufA, NULL);
SIO_reclaim(outStreamC, (Ptr)&bufA, NULL);
SIO_reclaim(outStreamD, (Ptr)&bufA, NULL, SYS_FOREVER);
```

Note: Using SIO_issue to send the same buffer to multiple devices does not work with device drivers that modify the data in the buffer, since the buffer is simultaneously being sent to multiple devices. For example, a stacking device that transforms packed data to unpacked data is modifying the buffer at the same time that another device is outputting the buffer.

The SIO_issue interface provides a method for allowing all communications drivers access to the same buffer of data. Each communications device driver, which typically uses DMA transfers, then transfers this buffer of data concurrently. The program does not return from the four SIO_reclaims until a buffer is available from all of the streams.

In summary, the SIO_issue/SIO_reclaim functions offer the most efficient method for the simultaneous transmission of data to more than one stream. This is not a reciprocal operation: the SIO_issue/SIO_reclaim model solves the scatter problem quite efficiently for output, but does not accommodate gathering multiple data sources into a single buffer for input.

7.8 Streaming Data Between Target and Host

You can configure host channel objects (HST objects), which allow an application to stream data between the target and files on the host. In DSP/BIOS analysis tools, you bind these channels to host files and start them.

DSP/BIOS includes a host I/O module (HST) that makes it easy to transfer data between the host computer and target program. Each host channel is internally implemented using an SIO stream object. To use a host channel, the program calls HST_getstream to get the corresponding stream handle, and then transfers the data using SIO calls on the stream.

You configure host channels, or HST objects, for input or output. Input channels transfer data from the host to the target, and output channels transfer data from the target to the host.

7.9 Device Driver Template

Since device drivers interact directly with hardware, the low-level details of device drivers can vary considerably. However, all device drivers must present the same interface to SIO. In the following sections, an example driver template called Dxx is presented. The template contains (mainly) C code for higher-level operations and pseudocode for lower-level operations. Any device driver should adhere to the standard behavior indicated for the Dxx functions.

You should study the Dxx driver template along with one or more actual drivers. You can also refer to the Dxx functions in the *TMS320 DSP/BIOS API Reference Guide* for your platform where xx denotes any two-letter combination. For details about configuring device drivers, including both custom drivers and the drivers provided with DSP/BIOS, you need to reference the specific device driver.

7.9.1 Typical File Organization

Device drivers are usually split into multiple files. For example:

- dxx.h—Dxx header file
- dxx.c—Dxx functions
- dxx_asm.s##—(optional) assembly language functions

Most of the device driver code can be written in C. The following description of Dxx does not use assembly language. However, interrupt service routines are usually written in assembly language for efficiency, and some hardware control functions also need to be written in assembly language.

We recommend that you become familiar at this point with the layout of one of the software device drivers, such as DGN. In particular, you should note the following points:

- The header file, dxx.h, typically contains the required statements shown in Example 7-17 in addition to any device-specific definitions:

Example 7-17 Required Statements in dxx.h Header File

```

/*
 * ===== dxx.h =====
 */

#include <dev.h>
extern DEV_Fxns    Dxx_FXNS;
/*
 * ===== Dxx_Params =====
 */
typedef struct {
    `device parameters go here`
} Dxx_Params;

```

- Device parameters, such as Dxx_Params, are specified as properties of the device object in the configuration.

The required table of device functions is contained in dxx.c. This table is used by the SIO module to call specific device driver functions. For example, SIO_put uses this table to find and call Dxx_issue/Dxx_reclaim. The table is shown in Example 7-18.

Example 7-18 Table of Device Functions

```

DEV_Fxns Dxx_FXNS = {
    Dxx_close,
    Dxx_ctrl,
    Dxx_idle,
    Dxx_issue,
    Dxx_open,
    Dxx_ready,
    Dxx_reclaim
};

```

7.10 Streaming DEV Structures

The DEV_Fxns structure contains pointers to internal driver functions corresponding to generic I/O operations as shown in Example 7-19.

Example 7-19 The DEV_Fxns Structure

```

typedef struct DEV_Fxns {
    Int      (*close) (DEV_Handle);
    Int      (*ctrl) (DEV_Handle, Uns, Arg);
    Int      (*idle) (DEV_Handle, Bool);
    Int      (*issue) (DEV_Handle);
    Int      (*open) (DEV_Handle, String);
    Bool     (*ready) (DEV_Handle, SEM_Handle);
    Int      (*reclaim) (DEV_Handle);
} DEV_Fxns;

```

Device frames are structures of type DEV_Frame used by SIO and device drivers to enqueue/dequeue stream buffers. The device→todevice and device→fromdevice queues contain elements of this type (Example 7-20).

Example 7-20 The DEV_Frame Structure

```

typedef struct DEV_Frame { /* frame object */
    QUE_Elem link; /* queue link */
    Ptr      addr; /* buffer address */
    Uns      size; /* buffer size */
    Arg      misc; /* reserved for driver */
    Arg      arg; /* user argument */
    Uns      cmd; /* mini-driver command */
    Int      status; /* status of command */
} DEV_Frame;

```

Example 7-20 has the following parameters:

- *link* is used by QUE_put and QUE_get to enqueue/dequeue the frame.
- *addr* contains the address of the stream buffer.
- *size* contains the logical size of the stream buffer. The logical size can be less than the physical buffer size.
- *misc* is an extra field which is reserved for use by a device.

- *arg* is an extra field available for you to associate information with a particular frame of data. This field should be preserved by the device.
- *cmd* is a command code for use with mini-drivers that use the IOM model described in the *DSP/BIOS Driver Developer's Guide* (SPRU616). The command code tells the mini-driver what action to perform.
- *status* is a field set by an IOM mini-driver before calling a callback function.

Device driver functions take a DEV_Handle as their first or only parameter, followed by any additional parameters. The DEV_Handle is a pointer to a DEV_Obj, which is created and initialized by SIO_create and passed to Dxx_open for additional initialization. Among other things, a DEV_Obj contains pointers to the buffer queues that SIO and the device use to exchange buffers. All driver functions take a DEV_Handle as their first parameter.

Example 7-21 The DEV_Handle Structure

```
typedef DEV_Obj *DEV_Handle;

typedef struct DEV_Obj { /* device object */
    QUE_Handle  todevice; /* downstream frames here */
    QUE_Handle  fromdevice; /* upstream frames here */
    Uns         bufsize; /* buffer size */
    Uns         nbufs; /* number of buffers */
    Int         segid; /* buffer segment ID */
    Int         mode; /* DEV_INPUT/DEV_OUTPUT */
    LgInt       devid; /* device ID */
    Ptr         params; /* device parameters */
    Ptr         object; /* ptr to dev instance obj */
    DEV_Fxns    fxns; /* driver functions */
    Uns         timeout; /* SIO_reclaim timeout value */
    Uns         align; /* buffer alignment */
    DEV_Callback *callback; /* pointer to callback */
} DEV_Obj;
```

Example 7-21 has the following parameters:

- *todevice* is used to transfer DEV_Frame frames to the device. In the SIO_STANDARD (DEV_STANDARD) streaming model, SIO_put puts full frames on this queue, and SIO_get puts empty frames here. In the SIO_ISSUERECLAIM (DEV_ISSUERECLAIM) streaming model, SIO_issue places frames on this queue.
- *fromdevice* is used to transfer DEV_Frame frames from the device. In the SIO_STANDARD (DEV_STANDARD) streaming model, SIO_put gets empty frames from this queue, and SIO_get gets full frames from here. In the SIO_ISSUERECLAIM (DEV_ISSUERECLAIM) streaming model, SIO_reclaim retrieves frames from this queue.
- *bufsize* specifies the physical size of the buffers in the device queues.
- *nbufs* specifies the number of buffers allocated for this device in the SIO_STANDARD streaming model, or the maximum number of outstanding buffers in the SIO_ISSUERECLAIM streaming model.
- *segid* specifies the segment from which device buffers were allocated (SIO_STANDARD).
- *mode* specifies whether the device is an input (DEV_INPUT) or output (DEV_OUTPUT) device.
- *devid* is the device ID.
- *params* is a generic pointer to any device-specific parameters. Some devices have additional parameters which are found here.

- *object* is a pointer to the device object. Most devices create an object that is referenced in successive device operations.
- *fxns* is a DEV_Fxns structure containing the driver's functions. This structure is usually a copy of Dxx_FXNS, but it is possible for a driver to dynamically alter these functions in Dxx_open.
- *timeout* specifies the number of system ticks that SIO_reclaim will wait for I/O to complete.
- *align* specifies the buffer alignment.
- *callback* specifies a pointer to a channel-specific callback structure. The DEV_Callback structure contains a callback function and two function arguments. The callback function is typically SWI_andnHook or a similar function that posts a SWI. Callbacks can only be used with the issue/reclaim model. This callback allows SIO objects to be used with SWI threads.

Only the object and fxns fields should ever be modified by a driver's functions. These fields are essentially output parameters of Dxx_open.

7.11 Device Driver Initialization

The driver function table Dxx_FXNS is initialized in dxx.c, as shown in Section 7.10, *Streaming DEV Structures*, page 7-201.

Additional initialization is performed by Dxx_init. The Dxx module is initialized when other application-level modules are initialized. Dxx_init typically calls hardware initialization routines and initializes static driver structures as shown in Example 7-22.

Example 7-22 Initialization by Dxx_init

```

/*
 * ===== Dxx_init =====
 */
Void Dxx_init()
{
    `Perform hardware initialization`
}

```

Although Dxx_init is required in order to maintain consistency with DSP/BIOS configuration and initialization standards, there are actually no DSP/BIOS requirements for the internal operation of Dxx_init. There is in fact no standard for hardware initialization, and it can be more appropriate on some systems to perform certain hardware setup operations elsewhere in Dxx, such as Dxx_open. Therefore, on some systems, Dxx_init might simply be an empty function.

7.12 Opening Devices

Dxx_open opens a Dxx device and returns its status seen in Example 7-23:

Example 7-23 Opening a Device with Dxx_open

```

status = Dxx_open(device, name);

```

SIO_create calls Dxx_open to open a Dxx device as seen in Example 7-24.

Example 7-24 Opening an Input Terminating Device

```
input = SIO_create("/adc16", SIO_INPUT, BUFSIZE, NULL)
```

This sequence of steps illustrates the opening process for an input-terminating device:

1. Find string matching a prefix of /adc16 in DEV_devtab device table. The associated DEV_Device structure contains driver function, device ID, and device parameters.
2. Allocate DEV_Obj device object.
3. Assign bufsize, nbufs, segid, etc. fields in DEV_Obj from parameters and SIO_Attrs passed to SIO_create.
4. Create todevice and fromdevice queues.
5. If opened for DEV_STANDARD streaming model, allocate attrs.nbufs buffers of size BUFSIZE and put them on todevice queue.
6. Call Dxx_open with pointer to new DEV_Obj and remaining name string using syntax as shown:

```
status - Dxx_open (device, "16")
```

7. Validate fields in DEV_Obj pointed to by device.
8. Parse string for additional parameters (for example, 16 kHz).
9. Allocate and initialize device-specific object.
10. Assign device-specific object to device→object.

The arguments to Dxx_open are shown in Example 7-25.

Example 7-25 Arguments to Dxx_open

```
DEV_Handle device;    /* driver handle */
String      name;     /* device name */
```

The device parameter points to an object of type DEV_Obj whose fields have been initialized by SIO_create. name is the string remaining after the device name has been matched by SIO_create using DEV_match.

Recall that SIO_create takes the parameters and is called as shown in Example 7-26.

Example 7-26 The Parameters of SIO_create

```
stream = SIO_create(name, mode, bufsize, attrs);
```

The name parameter passed to SIO_create is typically a string indicating the device and an additional suffix, indicating some particular mode of operation of the device. An analog-to-digital converter might have the base name /adc, while the sampling frequency might be indicated by a tag such as 16 for 16 kHz. The complete name passed to SIO_create would be /adc16.

SIO_create identifies the device by using DEV_match to match the string /adc against the list of configured devices. The string remainder 16 would be passed to Dxx_open to set the ADC to the correct sampling frequency.

Dxx_open usually allocates a device-specific object that is used to maintain the device state, as well as necessary semaphores. For a terminating device, this object typically has two SEM_Handle semaphore handles. One is used for synchronizing I/O operations (for example, SIO_get, SIO_put, SIO_reclaim). The other handle is used with SIO_select to determine if a device is ready. A device object would typically be defined as shown in Example 7-27.

Example 7-27 The Dxx_Obj Structure

```
typedef struct Dxx_Obj {
    SEM_Handle    sync;      /* synchronize I/O */
    SEM_Handle    ready;     /* used with SIO_select() */
    `other device-specific fields`
} Dxx_obj, *Dxx_Handle;
```

Example 7-28 provides a template for Dxx_open, showing the function's typical features for a terminating device.

Example 7-28 Typical Features for a Terminating Device

```
Int Dxx_open(DEV_Handle device, String name)
{
    Dxx_Handle objptr;

    /* check mode of device to be opened */
    if ( `device->mode is invalid` ) {
        return (SYS_EMODE);
    }
    /* check device id */
    if ( `device->devid is invalid` ) {
        return (SYS_ENODEV);
    }

    /* if device is already open, return error */
    if ( `device is in use` ) {
        return (SYS_EBUSY);
    }
    /* allocate device-specific object */
    objptr = MEM_alloc(0, sizeof (Dxx_Obj), 0);

    `fill in device-specific fields`
    /*
     * create synchronization semaphore ... */
    objptr->sync = SEM_create( 0 , NULL);
    /* initialize ready semaphore for
    SIO_select()/Dxx_ready() */
    objptr->ready = NULL;

    `do any other device-specific initialization required`

    /* assign initialized object */
    device->object = (Ptr)objptr;

    return (SYS_OK);
}
```

The first two steps take care of error checking. For example, a request to open an output-only device for input should generate an error message. A request to open channel ten on a five-channel system should also generate an error message.

The next step is to determine if the device is already opened. In many cases, an opened device cannot be re-opened, so a request to do so generates an error message.

If the device can be opened, the rest of `Dxx_open` consists of two major operations. First, the device-specific object is initialized, based in part on the `device->params` settings passed by `SIO_create`. Second, this object is attached to `device->object`. `Dxx_open` returns `SYS_OK` to `SIO_create`, which now has a properly initialized device object.

The configurable device parameters are used to set the operating parameters of the hardware. There are no DSP/BIOS constraints on which parameters should be set in `Dxx_init` rather than in `Dxx_open`.

The object semaphore `objptr->sync` is typically used to signal a task that is pending on the completion of an I/O operation. For example, a task can call `SIO_put`, which can block by pending on `objptr->sync`. When the required output is accomplished, `SEM_post` is called with `objptr->sync`. This makes a task blocked in `Dxx_output` ready to run.

DSP/BIOS does not impose any special constraints on the use of synchronization semaphores within a device driver. The appropriate use of such semaphores depends on the nature of the driver requirements and the underlying hardware.

The ready semaphore, `objptr->ready`, is used by `Dxx_ready`, which is called by `SIO_select` to determine if a device is available for I/O. This semaphore is explained in Section 4.7, *Semaphores*, page 4-127.

7.13 Real-Time I/O

In DSP/BIOS there are two models that can be used for real-time I/O—the `DEV_STANDARD` streaming model and the `DEV_ISSUERECLAIM` streaming model. Each of these models is described in this section.

7.13.1 *DEV_STANDARD Streaming Model*

In the `DEV_STANDARD` streaming model, `SIO_get` is used to get a non-empty buffer from an input stream. To accomplish this, `SIO_get` first places an empty frame on the `device->todevice` queue. `SIO_get` then calls `Dxx_issue`, which starts the I/O and then calls `Dxx_reclaim` pending, until a full frame is available on the `device->fromdevice` queue. This blocking is accomplished by calling `SEM_pend` on the device semaphore `objptr->sync` that is posted whenever a buffer is filled.

`Dxx_issue` calls a low-level hardware function to initiate data input. When the required amount of data has been received, the frame is transferred to `device->fromdevice`. Typically, the hardware device triggers an interrupt when a certain amount of data has been received. `Dxx` handles this interrupt by means of an HWI (ISR in Figure 7–8), which accumulates the data and determine if more data is needed for the waiting frame. If the HWI determines that the required amount of data has been received, the HWI transfers the frame to `device->fromdevice` and then call `SEM_post` on the device semaphore. This allows the task, blocked in `Dxx_reclaim`, to continue. `Dxx_reclaim` then returns to `SIO_get`, which will complete the input operation as illustrated in Figure 7–8.

Figure 7–8 Flow of DEV_STANDARD Streaming Model

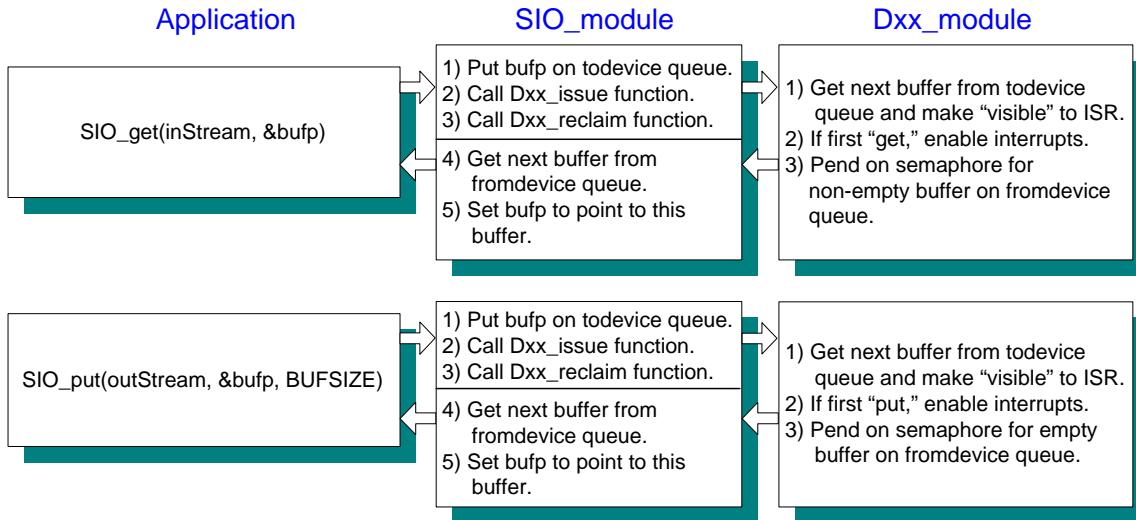

Note that objptr->sync is a counting semaphore and that tasks do not always block here. The value of objptr->sync represents the number of available frames on the fromdevice queue.

7.13.2 DEV_ISSUERECLAIM Streaming Model

In the DEV_ISSUERECLAIM streaming model, SIO_issue is used to send buffers to a stream. To accomplish this, SIO_issue first places the frame on the device->todevice queue. It then calls Dxx_issue which starts the I/O and returns.

Dxx_issue calls a low-level hardware function to initialize I/O.

SIO_reclaim is used to retrieve buffers from the stream. This is done by calling Dxx_reclaim, which blocks until a frame is available on the device->fromdevice queue. This blocking is accomplished by calling SEM_pend on the device semaphore objptr->sync, just as for Dxx_issue. When the device HWI (ISR in Figure 7–9 and Figure 7–10) posts to objptr->sync, Dxx_reclaim is unblocked, and returns to SIO_reclaim. SIO_reclaim then gets the frame from the device->fromdevice queue and returns the buffer. This sequence is shown in Figure 7–9 and Figure 7–10.

Figure 7–9 Placing a Data Buffer to a Stream

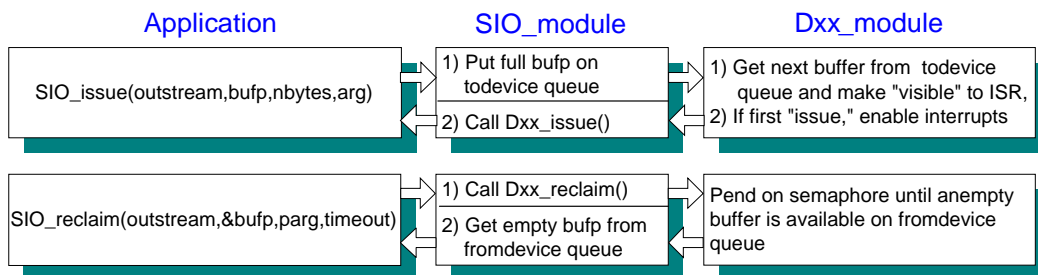

Figure 7–10 Retrieving Buffers from a Stream

Figure 7-29 is a template for `Dxx_issue` for a typical terminating device.

Example 7-29 Template for `Dxx_issue` for a Typical Terminating Device

```

/*
 * ===== Dxx_issue =====
 */
Int Dxx_issue(DEV_Handle device)
{
    Dxx_Handle objptr = (Dxx_Handle) device->object;

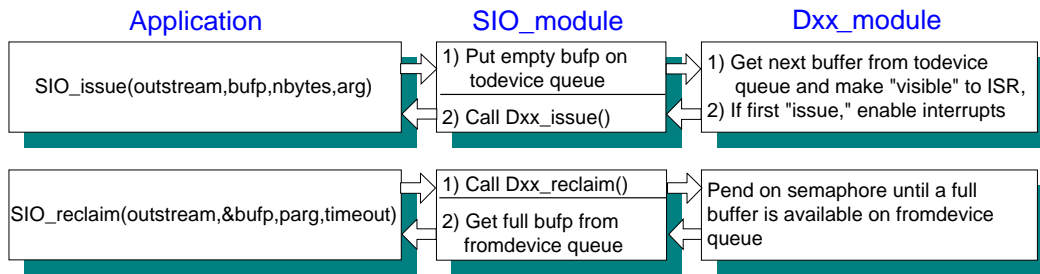
    if ( `device is not operating in correct mode` ) {
        `start the device for correct mode`
    }

    return (SYS_OK);
}
    
```

A call to `Dxx_issue` starts the device for the appropriate mode, either `DEV_INPUT` or `DEV_OUTPUT`. Once the device is known to be started, `Dxx_issue` simply returns. The actual data handling is performed by an HWI.

Figure 7-30 is a template for `Dxx_reclaim` for a typical terminating device.

Example 7-30 Template for `Dxx_reclaim` for a Typical Terminating Device

```

/*
 * ===== Dxx_reclaim =====
 */
Int Dxx_reclaim(DEV_Handle device)
{
    Dxx_Handle objptr = (Dxx_Handle) device->object;

    if (SEM_pend(objptr->sync, device->timeout)) {
        return (SYS_OK);
    }
    else { /* SEM_pend() timed out */
        return (SYS_ETIMEOUT);
    }
}
    
```

A call to `Dxx_reclaim` waits for the HWI to place a frame on the `device->fromdevice` queue, then returns.

Dxx_reclaim calls SEM_pend with the timeout value specified at the time the stream is created (either statically or with SIO_create) with this value. If the timeout expires before a buffer becomes available, Dxx_reclaim returns SYS_ETIMEOUT. In this situation, SIO_reclaim does not attempt to get anything from the device->fromdevice queue. SIO_reclaim returns SYS_ETIMEOUT, and does not return a buffer.

7.14 Closing Devices

A device is closed by calling SIO_delete, which in turn calls Dxx_idle and Dxx_close. Dxx_close closes the device after Dxx_idle returns the device to its initial state, which is the state of the device immediately after it was opened. This is shown in Example 7-31.

Example 7-31 Closing a Device

```

/*
 * ===== Dxx_idle =====
 */
Int Dxx_idle(DEV_Handle device, Bool flush)
{
    Dxx_Handle objptr = (Dxx_Handle) device->object;
    Uns      post_count;

    /*
     * The only time we will wait for all pending data
     * is when the device is in output mode, and flush
     * was not requested.
     */
    if ((device->mode == DEV_OUTPUT) && !flush)
    {
        /* first, make sure device is started */
        if ( `device is not started` &&
            `device has received data` ) {
            `start the device`
        }

        /*
         * wait for all output buffers to be consumed by the
         * output HWI. We need to maintain a count of how many
         * buffers are returned so we can set the semaphore later.
         */
        post_count = 0;
        while (!QUEUE_empty(device->todevice)) {
            SEM_pend(objptr->sync, SYS_FOREVER);
            post_count++;
        }

        if ( `there is a buffer currently in use by the HWI` ) {
            SEM_pend(objptr->sync, SYS_FOREVER);
            post_count++;
        }

        `stop the device`
    }
}

```

Example 7.31 Closing a Device (continued)

```

/*
 * Don't simply SEM reset the count here. There is a
 * possibility that the HWI had just completed working on a
 * buffer just before we checked, and we don't want to mess
 * up the semaphore count.
 */
    while (post_count > 0) {
        SEM_post(objptr->sync);
        post_count--;
    }
else {
    /* dev->mode = DEV_INPUT or flush was requested */
    `stop the device`

/*
 * do standard idling, place all frames in fromdevice
 * queue
 */
    while (!QUE_empty(device->todevice)) {
        QUE_put(device->fromdevice,
            QUE_get(device->todevice));
        SEM_post(objptr->sync);
    }
    return (SYS_OK);
}
    
```

The arguments to `Dxx_idle` are:

```

DEV_Handle device;    /* driver handle */

Bool          flush;  /* flush indicator */
    
```

The device parameter is, as usual, a pointer to a `DEV_Obj` for this instance of the device. `flush` is a boolean parameter that indicates what to do with any pending data while returning the device to its initial state.

For a device in input mode, all pending data is always thrown away, since there is no way to force a task to retrieve data from a device. Therefore, the flush parameter has no effect on a device opened for input.

For a device opened for output, however, the flush parameter is significant. If `flush` is `TRUE`, any pending data is thrown away. If `flush` is `FALSE`, the `Dxx_idle` function does not return until all pending data has been rendered.

7.15 Device Control

`Dxx_ctrl` is called by `SIO_ctrl` to perform a control operation on a device. A typical use of `Dxx_ctrl` is to change the contents of a device control register or the sampling rate for an A/D or D/A device. `Dxx_ctrl` is called as follows:

```

status = Dxx_ctrl(DEV_Handle device, Uns cmd, Arg arg);
    
```

- `cmd` is a device-specific command.

- arg provides an optional command argument.

Dxx_ctrl returns SYS_OK if the control operation was successful; otherwise, Dxx_ctrl returns an error code.

7.16 Device Ready

Dxx_ready is called by SIO_select to determine if a device is ready for I/O. Dxx_ready returns TRUE if the device is ready and FALSE if the device is not. The device is ready if the next call to retrieve a buffer from the device will not block. This usually means that there is at least one available frame on the queue device->fromdevice when Dxx_ready returns as shown in Example 7-32. Refer to Section 7.6, *Selecting Among Multiple Streams*, page 7-197, for more information on SIO_select.

Example 7-32 Making a Device Ready

```

Bool Dxx_ready(DEV_Handle dev, SEM_Handle sem)
{
    Dxx_Handle objptr = (Dxx_Handle)device->object;

    /* register the ready semaphore */
    objptr->ready = sem;

    if ((device->mode == DEV_INPUT) &&
        ((device->model == DEV_STANDARD) &&
         `device is not started` )) {
        `start the device`
    }

    /* return TRUE if device is ready */
    return ( `TRUE if device->fromdevice has a frame or
             device won't block` );
}

```

If the mode is DEV_INPUT, the streaming model is DEV_STANDARD. If the device has not been started already, the device is started. This is necessary, since in the DEV_STANDARD streaming model, SIO_select can be called by the application before the first call to SIO_get.

The device's ready semaphore handle is set to the semaphore handle passed in by SIO_select. To better understand Dxx_ready, consider the following details of SIO_select.

SIO_select can be summarized in pseudocode as shown in Example 7-33.

Example 7-33 SIO_Select Pseudocode

```

/*
 * ===== SIO_select =====
 */
Uns SIO_select(streamtab, n, timeout)
    SIO_Handle streamtab[]; /* array of streams */
    Int n; /* number of streams */
    Uns timeout; /* passed to SEM_pend() */
{
    Int i;
    Uns mask = 1; /* used to build ready mask */
    Uns ready = 0; /* bit mask of ready streams */
    SEM_Handle sem; /* local semaphore */
    SIO_Handle *stream; /* pointer into streamtab[] */

    /*
     * For efficiency, the "real" SIO_select() doesn't call
     * SEM_create() but instead initializes a SEM_Obj on the
     * current stack.
     */
    sem = SEM_create(0, NULL);

    stream = streamtab;

    for (i = n; i > 0; i--, stream++) {
        /*
         * call each device ready function with 'sem'
         */
        if ( `Dxx_ready(device, sem)` )
            ready = 1;
    }

    if (!ready) {
        /* wait until at least one device is ready */
        SEM_pend(sem, timeout);
    }
    ready = 0;

    stream = streamtab;

    for (i = n; i > 0; i--, stream++) {
        /*
         * Call each device ready function with NULL.
         * When this loop is done, ready will have a bit set
         * for each ready device.
         */
        if ( `Dxx_ready(device, NULL)` )
            ready |= mask;
        mask = mask << 1;
    }

    return (ready);
}

```

SIO_select makes two calls to Dxx_ready for each Dxx device. The first call is used to register sem with the device, and the second call (with sem = NULL) is used to un-register sem.

Each Dxx_ready function holds on to sem in its device-specific object (for example, objptr->ready = sem). When an I/O operation completes (that is, a buffer has been filled or emptied), and objptr->ready is not NULL, SEM_post is called to post objptr->ready.

If at least one device is ready, or if SIO_select was called with timeout equal to 0, SIO_select does not block; otherwise, SIO_select pends on the ready semaphore until at least one device is ready, or until the time-out has expired.

Consider the case where a device becomes ready before a time-out occurs. The ready semaphore is posted by whichever device becomes ready first. SIO_select then calls Dxx_ready again for each device, this time with sem = NULL. This has two effects. First, any additional Dxx device that becomes ready will not post the ready semaphore. This prevents devices from posting to a semaphore that no longer exists, since the ready semaphore is maintained in the local memory of SIO_select. Second, by polling each device a second time, SIO_select can determine which devices have become ready since the first call to Dxx_ready, and set the corresponding bits for those devices in the ready mask.

7.17 Types of Devices

There are two main types of devices: terminating devices and stackable devices. Each exports the same device functions, but they implement them slightly differently. A terminating device is any device that is a data source or sink. A stackable device is any device that does not source or sink data, but uses the DEV functions to send (or receive) data to or from another device. Refer to Figure 7–11 to see how the stacking and terminating devices fit into a stream.

Figure 7–11 Stacking and Terminating Devices

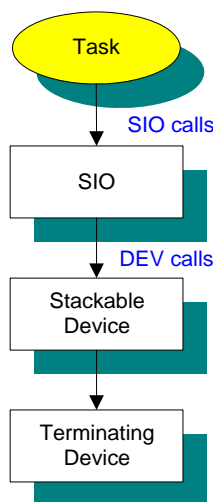

Within the broad category of stackable devices, there are two distinct types. These are referred to as in-place stacking devices and copying stacking devices. The in-place stacking device performs in-place manipulations on data in buffers. The copying stacking device moves the data to another buffer while processing the data. Copying is necessary for devices that produce more data than they receive (for example, an unpacking device or an audio decompression driver), or because they require access to the whole buffer to generate output samples and cannot overwrite their input data (for example, an FFT driver). These types of stacking devices require different implementation, since the copying device might have to supply its own buffers.

Figure 7–12 shows the buffer flow of a typical terminating device. The interaction with DSP/BIOS is relatively simple. Its main complexities exist in the code to control and stream data to and from the physical device

Figure 7–12 Buffer Flow in a Terminating Device

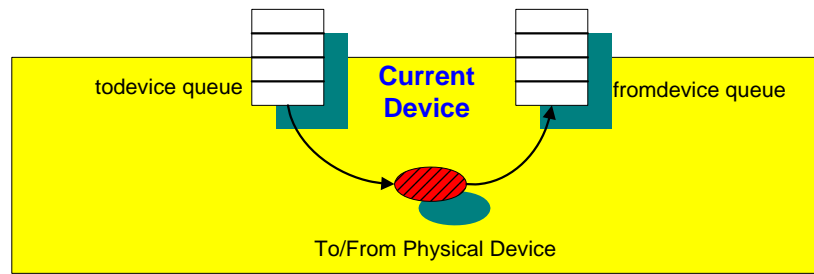

Figure 7–13 shows the buffer flow of an in-place stacking driver. All data processing is done in a single buffer. This is a relatively simple device, but it is not as general-purpose as the copying stacking driver.

Figure 7–13 In-Place Stacking Driver

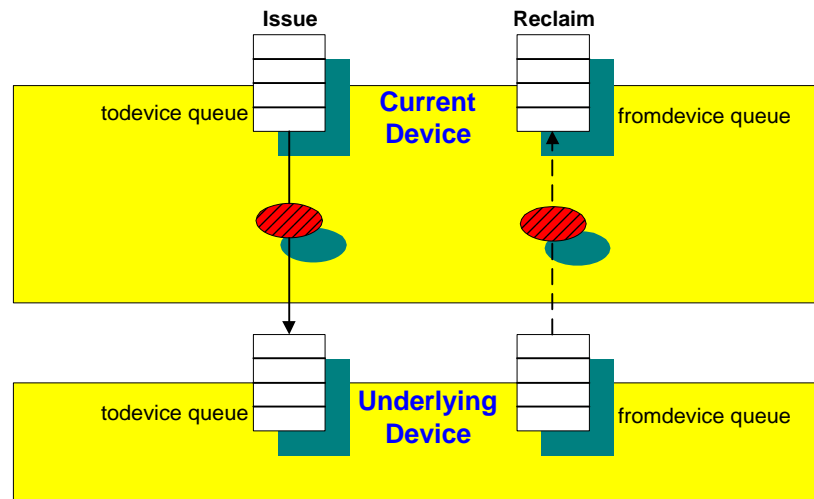
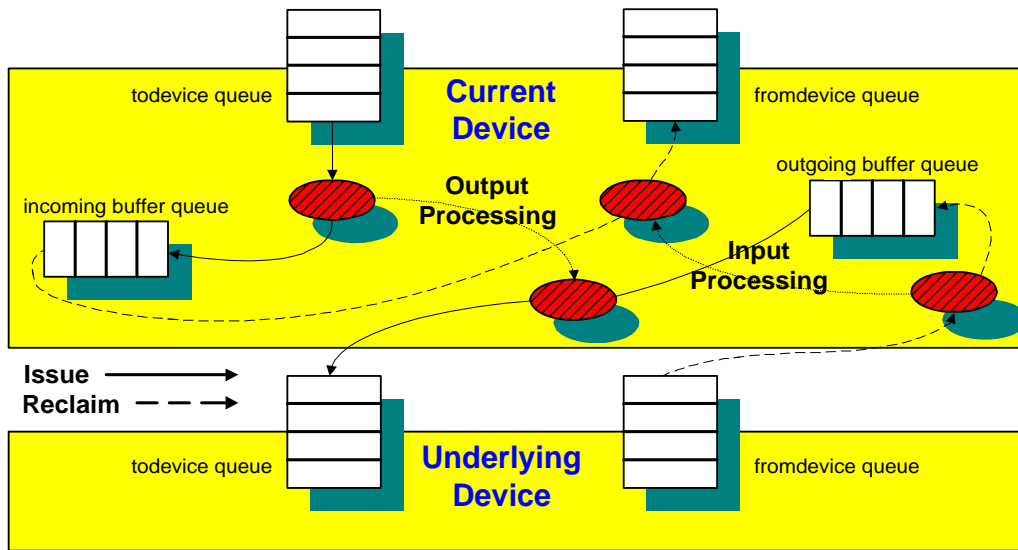

Figure 7–14 shows the buffer flow of a copying stacking driver. Notice that the buffers that come down from the task side of the stream never actually move to the device side of the stream. The two buffer pools remain independent. This is important, since in a copying stacking device, the task-side buffers can be a different size than the device-side buffers. Also, care is taken to preserve the order of the buffers coming into the device, so the SIO_ISSUERECLAIM streaming model can be supported

Figure 7–14 Copying Stacking Driver Flow



- .bss section 36
- .c files 39
- .h files 19, 39
- .o29 files 39
- .o50 files 39
- .o62 files 39
- .pinit table 43
- .tcf file 16, 33
- *.cmd 39
- *.obj 39

A

- algorithm
 - times 68
- alignment
 - of memory 146
- allocators 168, 172
- Analysis Tools 18, 19, 50, 73
- application stack
 - measuring 75
- application stack size 105
- Arg 21
- assembly header files 39
- atomic queue 153
- attributes
 - assigning 38
- autoinit.c 43
- average 67

B

- B14 register 35
- background processes 85
- background threads
 - suggested use 86
- BIOS_init 43, 44
- BIOS_start 44
- BIOSREGS memory segment 22
- Bool 21
- boot.c 43
- buffer
 - length 65
- buffer size
 - LOG objects 63
- buffers
 - and devices 183
 - and streams 183

- exchanging 182, 185

C

- C run-time 100
- C++ 45
- calloc 42
- catastrophic failure 113
- channels 176
- Char 21
- class constructor 47
- class destructor 47
- class methods 46
- clear 67
- CLK
 - default configuration 139
- CLK functions 138
- CLK manager 44
- CLK module 137
- CLK_F_isr function 20
- CLK_startup 44
- clktest1.c 139
- clock 137
 - CLK example 139
 - See also CLK module
- clock functions 86
 - suggested use 86
- clocks
 - real time vs. data-driven 141
- Code Composer Studio
 - debugging capabilities of 19
- compiling 40
- components 14
- configuration 16, 33
 - steps 31
- constant 21
- constants
 - trace 71
 - trace enabling 71
- conventions 19
- count 67, 76
- counting semaphores. See semaphores
- CPU load 20, 62, 73, 74
 - measuring 73
 - tracking 68
- CPU Load tool 56
- create function 116
- current value 68
- cyclic debugging 50

D

data
 exchange sequence 207
 exchanging with devices 207
 gathering 64, 71
 data analysis 68
 data notification functions 86
 data transfer 177
 data types 21
 data value
 monitoring 77
 debugging 59
 environment 14
 delete function 116
 DEV_ISSUERECLAIM. *See* Issue/Reclaim streaming model
 DEV_STANDARD. *See* standard streaming model
 development cycle 33
 device
 name 62
 device drivers
 and synchronization semaphores 206
 file organization 200
 header file 200
 object 202
 standard interface 200
 structures 201
 table of functions 181
 devices
 closing 209
 See also *Dxx_close*, *SIO_delete*
 communication 196
 controlling 196, 210
 See also *Dxx_ctrl*, *SIO_ctrl*
 DEV_Fxns table 182
 DEV_Handle 202
 DEV_Obj 202
 exchanging data 206, 207
 frame structure 201
 idling 209, 210, 211, 212
 See also *Dxx_idle*
 initialization of 203
 opening 203
 parameters 200
 readying 211
 See also *Dxx_ready*, *SIO_select*
 stackable 213
 stacking 192
 synchronizing 197
 terminating 213
 typedef structure 205
 virtual 192
 DSP/BIOS
 Analysis Tools 18
 DSP/BIOS Configuration Tool 16, 33

 files generated 40
 Dxx_ctrl 210
 Dxx_idle 209
 example code 209, 210, 211, 212
 Dxx_init 203
 Dxx_input
 initiating data input 206
 Dxx_issue
 initializing I/O 207
 sample code for a terminating device 208
 Dxx_open
 and terminating device 205
 error checking 206
 operation of 206
 Dxx_ready
 example code 211
 dxx.h 200
 dynamic object 38

E

EDATA memory segment 22
 EDATA1 memory segment 22
 environment registers 100
 EPROG memory segment 22
 EPROG1 memory segment 22
 error handling
 by Dxx_open 206
 program errors 152
 SPOX system services 152
 Event Log Manager 64, 65
 examples
 controlling streams 197, 198, 199, 200, 201, 202,
 203, 204, 205, 208, 209, 210, 211, 212
 Dxx_idle 209, 210, 211, 212
 Dxx_issue and terminating device 208
 Dxx_ready 211
 memory management 148
 multiple streams 198
 SIO_select 212
 system clock 139
 task hooks for extra context 116
 virtual I/O devices 192
 Excel
 Microsoft 80
 executable files 39
 execution mode
 blocked 114
 priority level 114
 ready 114
 running 114
 terminated 114
 TSK_BLOCKED 115
 TSK_READY 115
 TSK_RUNNING 115
 TSK_TERMINATED 115

execution times 63
 exit function 116
 explicit instrumentation 65

F

FALSE 21
 far
 keyword 36, 37
 fast return 45
 field testing 79
 file names 39
 file streaming 19
 files
 generated by Configuration Tool 40
 fragmentation of memory, minimizing 148
 free 42
 frequencies
 typical for HWI vs. SWI
 function names 20, 45

G

global data 35
 accessing 35
 global object pointer 36
 gmake 40
 gmake.exe 40
 GPPs
 messaging with 167

H

halting program execution
 SYS_abort 151
 SYS_exit 151
 handle 38
 hardware interrupt
 and SEM_post or SEM_ipost 128
 hardware interrupts 85
 counting 75
 statistics 77
 typical frequencies
 header files 39
 including 19
 naming conventions 19
 heap
 end 62
 size 62
 start 62
 high-resolution times 137
 hook functions 116
 HOOK module 116
 HOOK_KNL object 116
 Host Channel Manager 64
 host channels 176
 host clear 67
 host operation 79
 HST module 176
 for instrumentation 64

HST_init 43
 HWI
 dispatching 99
 parameters 99
 writing 91
 HWI accumulations
 enable 76
 HWI dispatcher 99
 HWI interrupt
 triggering 91
 HWI interrupts. *See* hardware interrupts
 HWI ISR
 and mailboxes 133
 HWI module
 implicit instrumentation 75
 HWI_disable 92
 HWI_enable 92
 HWI_enter
 and HWI_exit 99
 HWI_restore 92
 versus HWI_enable 98
 HWI_startup 44
 HWI_unused 20

I

I/O
 and driver functions 181
 performance 178
 real-time 206
 I/O devices, virtual 192
 IDATA memory segment 22
 identifier 19
 IDL manager 120
 IDL thread 62
 IDL_busyObj 74
 IDL_cpuLoad 121
 IDL_F_busy function 20
 IDL_init 43
 IDL_loop 20, 74
 idle loop 44, 74, 89, 120
 instruction count box 75
 IDRAM0 memory segment 22
 IDRAM1 memory segment 22
 IER 43
 implicit instrumentation 73
 initialization function 116
 initialize 43, 44
 43
 See also .bss section 43
 instructions
 number of 68
 instrumentation 49, 50, 64, 71
 explicit 71
 explicit vs. implicit 65
 hardware interrupts 77
 implicit 72, 73, 77
 software vs. hardware 50
 Int 21
 interrupt
 configuring 92
 context and management 98

- enabling and disabling 92
- hardware 91
- keyword 92
- software 102
- software triggering 102
- interrupt latency 78
- interrupt service routine 43
- interrupt service table 43
- interrupts 91
- inter-task synchronization 127
- IPRAM memory segment 22
- IPROG memory segment 22
- ISR 43, 73
 - HWI_enter 100
 - HWI_exit 100
- Issue/Reclaim streaming model 183, 184, 202, 207
- IVPD 44
- IVPH 44

J

- JTAG 81

K

- kernel 15
- KNL_run 20

L

- LabVIEW 80
- large model 37
- LgInt 21
- LgUns 21
- linker
 - command file 28, 42
 - options 42
- linker switch 42
- linking 40
- LNK_dataPump 120
- LNK_dataPump object 178
- LNK_F_dataPump 20
- Load Data tool 58
- Log
 - records on host 55
- log 65
 - circular 65
 - fixed 65
- LOG module
 - explicit instrumentation 65
 - overview 65
- LOG_printf 42
- logs
 - performance 62
- low-resolution times 137

M

- MADU 151
- mailbox
 - and SWI objects 106
 - handle 61
 - length 136
 - memory segment number 61
 - message size 61
 - messages 61
 - name 61
 - priority 136
 - scheduling 136
 - wait time 136
- mailboxes 61
 - creating. See MBX_create
 - deleting. See MBX_delete
 - MBX example 133
 - MBX module 132
 - posting a message to. See MBX_post
 - reading a message from. See MBX_pend
- makefile 40
- makefiles 40
- malloc 42
- map file 42
- mask
 - predefined 100
- MAU 146
- maximum 67
- MBX_create 132
- MBX_delete 132
- MBX_pend 133
- MBX_post 133
- MEM manager 28
- Mem manager 36
- MEM module 143
- MEM_alloc 146
- MEM_free 147
- MEM_stat 147
- memory
 - contiguous 61
 - freeing 38
 - management functions 42
 - segment names 22
- memory management 143
 - allocating. See MEM_alloc
 - freeing. See MEM_free
 - MEM example 148
 - reducing fragmentation 148
- memory page
 - in Kernel View 61
- memory segment
 - declare 36
- memory, alignment of 146
- message log
 - message numbering 66
- message queues 167
- message slots 136
- Minimum addressable data units 151
- minimum addressable unit. See MAU
- mode
 - continuous 82
 - non-continuous 82

modules
 MSGQ 167
 MSGQ module 167
 MSGQ_config variable 170
 MSGQ_TransportObj structure 171
 multi-processor messaging 167
 multitasking. *See* tasks

N

name mangling 45, 46
 name overloading 46
 namespace
 and device parameters 200
 and devices 192
 naming conventions 19, 45
 near
 keyword 37
 nmti 76
 notify function 177
 notifyReader function 163
 notifyWriter function 163
 NULL 21

O

object
 pre-configured 17
 SWI 103
 object files 39
 object names 20
 object structures 21
 Object Viewer 59
 objects
 deleting 38
 naming conventions 19
 referencing 34
 OLE 79, 81
 automation client 82
 OLE/ActiveX 80
 opening, devices 203
 operations
 HWI objects 79
 names 20
 optimization
 instrumentation 62
 overview 14

P

performance
 I/O 178

instrumentation 62
 real-time statistics 68
 performance monitoring 19
 period 68
 Periodic Function Manager 140
 periodic functions 86
 suggested use 86
 PIP_startup 44
 poll rate 62
 polling
 disabled 67
 POOL module 172
 portability 21
 PRD functions 141
 PRD module
 implicit instrumentation 142
 PRD_F_swi 20
 PRD_F_tick function 20
 predefined masks 100
 preemption 89
 previous value field 68
 printf 42
 Printf Logs tool 56
 priorities
 setting for software interrupts 104
 processes 85
 program
 error handling. *See* SYS_error
 halting execution of 151
 program analysis 49
 program tracing 19
 program.cdb 40
 program.tcf 39
 programcfg_c.c 40
 programcfg.cmd 40
 programcfg.h 40
 programcfg.h62 40
 programcfg.obj 40
 programcfg.s62 40
 project
 creating 26
 Ptr 21
 PWRM_idleDomains 121

Q

queue
 QUE module 153
 Quinn-Curtis 80

R

rate
 clock ticks 138

- polling 62, 67, 75
- Raw Logs tool 55
- ready function 116
- realloc 42
- real-time 64
- real-time analysis 50
 - See *also* RTA 15
- Real-Time Analysis tools 51
- Real-Time Data Exchange
 - See RTDX
- real-time deadline 141
- real-time I/O 206
- Real-Time versus Cyclic Debugging 50
- Refresh Window 68
- register
 - monitoring 77
- register context
 - extending 116
- registers
 - monitoring in HWI 77
 - saving and restoring 102
 - saving when preempted 111
- reserved function names 20
- ROV 59
- RTA Control Panel 54, 72
- RTA tools 51
- RTA_dispatcher 120
- RTA_F_dispatch function 20
- RTDX 42, 79
 - data flow 81
 - header files 29
 - host library 81
- RTOS Object Viewer 59
- rts.src 42
- Runtime Object Viewer 59
- run-time support library 42

S

- SBSRAM memory segment 22
- SDRAM0 memory segment 22
- SDRAM1 memory segment 22
- See *also* startup 43
- SEM_create 127
- SEM_delete 127
- SEM_pend 128
- SEM_post 128
- semaphore
 - count 61
 - handle 61
 - name 61
- semaphores 61, 127
 - creating. See SEM_create
 - deleting. See SEM_delete
 - signal. See SEM_post
 - synchronization, and device drivers 206
 - waiting on. See SEM_pend
- servo 80
- SIO module
 - mapping to driver function table 181
- SIO_create
 - name passed to 204
 - to open devices 182
- SIO_ctrl
 - general calling format 196
- SIO_delete
 - to close devices 183
- SIO_flush
 - to synchronize devices 197
- SIO_get
 - exchanging buffers 183
- SIO_idle
 - to synchronize devices 197
- SIO_ISSUERECLAIM. See Issue/Reclaim streaming model
- SIO_put
 - outputting and exchanging buffers 183
- SIO_reclaim
 - retrieving buffers 207
- SIO_select
 - and multiple streams 197
 - calls to Dxx_ready 212
 - pseudo-code 212
- SIO_STANDARD. See standard streaming model
- slow return 45
- small model 35, 36
- software interrupt 73
 - and application stack size 105
 - creating 103
 - deleting 112
 - enabling and disabling 112
 - execution 105
 - handle 60
 - mailbox 60
 - name 60
 - priorities 104
 - priority 60
 - priority levels 105
 - state 60
- software interrupt handler (SWI handler) 102
 - creating and deleting 103
 - synchronizing 111
 - using 110
- software interrupts 85
 - benefits and tradeoffs 110
 - setting priorities 104
 - suggested use 86
- software interrupts page
 - in Kernel Object View 60
- software interrupts. See interrupts
- source files 39
- space requirements 67
- SPOX error conditions 152
- stack
 - end 60
 - size 60
 - start 60
- stack modes 45
- stack overflow 115
- stack overflow check 115
- stack pointer 76
- stack size
 - and task objects 112
- stackable devices
 - writing 213
- standard streaming model 183, 202

- and buffers 183
- implementing 183
- standardization 13
- startup 43
- startup sequence 43
- static configuration 16, 33
- static objects 37
- statistics 62
 - accumulating 68
 - gathering 142
 - performance 62
 - units 142
- Statistics Data tool 58, 67
- Statistics Manager 67
- Statistics Object Manager 64
- std.h 20, 21
- std.h header file 21
- streaming models 183
 - main description 206
 - See also Issue/Reclaim, standard streaming model
- streams
 - buffer exchange 182
 - buffer management 185
 - controlling 196
 - creating 183
 - creating. See SIO_create 183
 - data buffer input 183
 - data buffer input. See also SIO_get 183
 - data buffer output 183
 - data buffer output. See also SIO_put 183
 - definition of 158
 - deleting. See also SIO_delete 183
 - idle 197
 - input 158
 - multiple 197
 - output 158
 - polling 198
 - reading data from 183
 - selecting among multiple 197
- String
 - Uns 21
- STS module
 - explicit instrumentation 67
 - implicit instrumentation 142
 - operations on registers 77
 - overview 67
- STS operations 78
- STS_add 67, 68
 - uses of 78
- STS_delta 67, 68
 - uses of 78
- STS_set 67, 68
- suspended mode 114
- SWI 102
 - and blocking 106
 - and preemption 106
 - posting 107
 - Property window 104
- SWI module
 - implicit instrumentation 142
- SWI object 103
- SWI_getattrs 103

- SWI_startup 44
- switch function 116
- synchronization 15
- SYS module 151
- SYS_error 152, 153
- system clock 137, 139
- system clock parameters 137
- system services
 - handling errors 152
 - SYS module 151
- system stack 60, 90

T

- target executable 39
- task
 - execution state 114
 - handle 60
 - name 60
 - priority 60
 - scheduler 90
 - scheduling 114
 - stack usage 60
 - state 60
- Task Manager 44
- task stack
 - overflow checking 115
- tasks 84
 - blocked 115
 - creating 113
 - creating. See TSK_create
 - deleting. See TSK_delete
 - execution modes. See execution mode
 - hook functions 116
 - idle 115
 - preserving hardware registers 116
 - priority levels 114
 - scheduling 115
 - task objects 112
 - terminating. See TSK_exit
 - TSK module 112
- Tconf script 16, 33
- textual scripting 16, 33
- thread 14
 - preemption 90
 - priorities 88
 - type comparisons 87
- threads
 - choosing types 86
- time
 - idle 73
 - work 73
- timer
 - interrupt rate 138
- timer counter register 138
- time-slicing scheduling 118
- timing methods 137
- total 67
- trace state 71
 - performance 62
- tracing 62
- transports 169, 172

TRC module 62
 control of implicit instrumentation 71
 explicit instrumentation 70
TRC_disable 72
 constants 71
TRC_enable 72
 constants 71
TRUE 21
TSK_create 113
TSK_delete 113
TSK_exit 115
 when automatically called 115
TSK_startup 44
type casting 131, 140

U

Uninitialized Variables Memory 36
USER_traces 72
user traces 62
user-defined logs 65
USERREGS memory segment 22

V

value
 current 68
 difference 68
 previous 68
variable-length messages 167
variables
 monitoring 77
 watching 77
VECT memory segment 22
Visual Basic 80
Visual C++ 80
Void 21

W

words
 data memory 63
 of code 15
wrapper function 46

IMPORTANT NOTICE

Texas Instruments Incorporated and its subsidiaries (TI) reserve the right to make corrections, modifications, enhancements, improvements, and other changes to its semiconductor products and services per JESD46C and to discontinue any product or service per JESD48B. Buyers should obtain the latest relevant information before placing orders and should verify that such information is current and complete. All semiconductor products are sold subject to TI's terms and conditions of sale supplied at the time of order acknowledgment.

TI warrants performance of its components to the specifications applicable at the time of sale, in accordance with the warranty in TI's terms and conditions of sale of semiconductor products. Testing and other quality control techniques are used to the extent TI deems necessary to support this warranty. Except where mandated by applicable law, testing of all parameters of each component is not necessarily performed.

TI assumes no liability for applications assistance or the design of Buyers' products. Buyers are responsible for their products and applications using TI components. To minimize the risks associated with Buyers' products and applications, Buyers should provide adequate design and operating safeguards.

TI does not warrant or represent that any license, either express or implied, is granted under any patent right, copyright, mask work right, or other intellectual property right relating to any combination, machine, or process in which TI components or services are used. Information published by TI regarding third-party products or services does not constitute a license to use such products or services or a warranty or endorsement thereof. Use of such information may require a license from a third party under the patents or other intellectual property of the third party, or a license from TI under the patents or other intellectual property of TI.

Reproduction of significant portions of TI information in TI data books or data sheets is permissible only if reproduction is without alteration and is accompanied by all associated warranties, conditions, limitations, and notices. TI is not responsible or liable for such altered documentation. Information of third parties may be subject to additional restrictions.

Resale of TI components or services with statements different from or beyond the parameters stated by TI for that component or service voids all express and any implied warranties for the associated TI component or service and is an unfair and deceptive business practice. TI is not responsible or liable for any such statements.

Buyer acknowledges and agrees that it is solely responsible for compliance with all legal, regulatory and safety-related requirements concerning its products, and any use of TI components in its applications, notwithstanding any applications-related information or support that may be provided by TI. Buyer represents and agrees that it has all the necessary expertise to create and implement safeguards which anticipate dangerous consequences of failures, monitor failures and their consequences, lessen the likelihood of failures that might cause harm and take appropriate remedial actions. Buyer will fully indemnify TI and its representatives against any damages arising out of the use of any TI components in safety-critical applications.

In some cases, TI components may be promoted specifically to facilitate safety-related applications. With such components, TI's goal is to help enable customers to design and create their own end-product solutions that meet applicable functional safety standards and requirements. Nonetheless, such components are subject to these terms.

No TI components are authorized for use in FDA Class III (or similar life-critical medical equipment) unless authorized officers of the parties have executed a special agreement specifically governing such use.

Only those TI components which TI has specifically designated as military grade or "enhanced plastic" are designed and intended for use in military/aerospace applications or environments. Buyer acknowledges and agrees that any military or aerospace use of TI components which have not been so designated is solely at the Buyer's risk, and that Buyer is solely responsible for compliance with all legal and regulatory requirements in connection with such use.

TI has specifically designated certain components which meet ISO/TS16949 requirements, mainly for automotive use. Components which have not been so designated are neither designed nor intended for automotive use; and TI will not be responsible for any failure of such components to meet such requirements.

Products

Audio	www.ti.com/audio
Amplifiers	amplifier.ti.com
Data Converters	dataconverter.ti.com
DLP® Products	www.dlp.com
DSP	dsp.ti.com
Clocks and Timers	www.ti.com/clocks
Interface	interface.ti.com
Logic	logic.ti.com
Power Mgmt	power.ti.com
Microcontrollers	microcontroller.ti.com
RFID	www.ti-rfid.com
OMAP Mobile Processors	www.ti.com/omap
Wireless Connectivity	www.ti.com/wirelessconnectivity

Applications

Automotive and Transportation	www.ti.com/automotive
Communications and Telecom	www.ti.com/communications
Computers and Peripherals	www.ti.com/computers
Consumer Electronics	www.ti.com/consumer-apps
Energy and Lighting	www.ti.com/energy
Industrial	www.ti.com/industrial
Medical	www.ti.com/medical
Security	www.ti.com/security
Space, Avionics and Defense	www.ti.com/space-avionics-defense
Video & Imaging	www.ti.com/video

TI E2E Community

e2e.ti.com